



INSTRUCTION MANUAL

VHF MARINE TRANSCEIVER **GM600**



Icom Inc.

Thank you for choosing this Icom product.

This product is designed and built with Icom's state of the art technology and craftsmanship.

With proper care, this product should provide you with years of trouble-free operation.

The GM600 VHF MARINE TRANSCEIVER has the Class A DSC functions for a distress alert transmission and reception, as well as the general DSC calls (Individual call, All Ships call, Group call, and so on).

You must connect the GM600 to the DC power supply through the PS-310 DC-DC POWER SUPPLY that is sold as a set with the GM600.

EN60945 Environmental category

The GM600 is protected from the weather.

The PS-310 is protected from the weather.

IMPORTANT

READ ALL INSTRUCTIONS carefully and completely before using the transceiver.

SAVE THIS INSTRUCTION MANUAL — This instruction manual contains important operating instructions for the GM600.

EXPLICIT DEFINITIONS

WORD	DEFINITION
 WARNING!	Personal injury, fire hazard or electric shock may occur.
CAUTION	Equipment damage may occur.
NOTE	If disregarded, inconvenience only. No risk of personal injury, fire or electric shock.

DISPOSAL



The crossed-out wheeled-bin symbol on your product, literature, or packaging reminds you that in the European Union, all electrical and electronic products, batteries, and accumulators (rechargeable batteries) must be taken to designated collection locations at the end of their working life. Do not dispose of these products as unsorted municipal waste. Dispose of them according to the laws in your area.

Icom and the Icom logo are registered trademarks of Icom Incorporated (Japan) in Japan, the United States, the United Kingdom, Germany, France, Spain, Russia, Australia, New Zealand, and/or other countries.

IN CASE OF EMERGENCY

If your vessel requires assistance, contact other vessels and the Coast Guard by sending a Distress call on Channel 16.

USING CHANNEL 16

DISTRESS CALL PROCEDURE

1. "MAYDAY MAYDAY MAYDAY."
2. "THIS IS" (name of vessel).
3. Say your call sign or other description of the vessel (AND 9 digit DSC ID if you have one).
4. "LOCATED AT" (your position).
5. State the nature of the distress and assistance required.
6. Give any other information which might facilitate the rescue.

Or, transmit your Distress call using digital selective calling on Channel 70.

USING DIGITAL SELECTIVE CALLING (Ch 70)

DISTRESS CALL PROCEDURE

1. While lifting up the key cover, hold down [DISTRESS] for 3 seconds until you hear 3 short beeps and then one long beep.
2. Wait for an acknowledgment on Channel 70 from a coast station.
 - After the acknowledgment is received, Channel 16 is automatically selected.
3. Hold down [PTT], then transmit the appropriate information as listed above.

INSTALLATION NOTE

Installation:

The installation of this equipment should be made in such a manner as to respect the EC recommended electromagnetic field exposure limits. (1999/519/EC)

The maximum RF power available from this device is 25 watts. The antenna should be installed as high as possible for maximum efficiency and the installation height should be at least 1.76 meters above any accessible position. In the case where an antenna cannot be installed at a reasonable height, then the transmitter should neither be continuously operated for long periods if any person is within a distance of 1.76 meters of the antenna, nor operated at all if any person is touching the antenna.

It is recommended that antenna of a maximum gain of 3 dB is used. If higher gain antenna are required then please contact your Icom distributor for revised installation recommendations.

Operation:

The exposure to RF electromagnetic field is only applicable when this device is transmitting. This exposure is naturally reduced due to the nature of alternating periods of receiving and transmitting. Keep your transmissions to the minimum necessary.

PRECAUTIONS

⚠ **WARNING! NEVER** connect the transceiver to an AC outlet. This may pose a fire hazard or result in an electric shock.

⚠ **WARNING! NEVER** connect the transceiver to an external DC power supply directly. The transceiver must be connected to the DC power supply through the PS-310 DC-DC POWER SUPPLY that is sold as a set with this transceiver. Be sure to not connect with reverse polarity.

PS-310 version	Input voltage	Output voltage
#11	21.6 to 31.2 V DC	12.6 V DC
#12	10.8 to 15.6 V DC	12.6 V DC

⚠ **WARNING! NEVER** cut the DC power cable between the DC plug at the back of the transceiver/PS-310 and the fuse holder. If an incorrect connection is made, the transceiver may be damaged.

CAUTION: NEVER place the transceiver where normal operation of the vessel may be hindered, or where it could cause bodily injury.

KEEP the transceiver and microphone at least 1 meter away from the vessel's magnetic navigation compass.

DO NOT place or leave the transceiver in areas with temperatures below -15°C or above $+55^{\circ}\text{C}$, or in areas subject to direct sunlight, such as a dashboard.

DO NOT use harsh solvents such as Benzine or alcohol to clean the transceiver, as they will damage the transceiver's surfaces. If the transceiver becomes dusty or dirty, wipe it clean with a soft, dry cloth.

BE CAREFUL! The transceiver rear panel will become hot when operating continuously for long periods of time.

NEVER place the transceiver in an insecure place to avoid inadvertent use by unauthorized persons.

BE CAREFUL! The transceiver's front panel meets IPX7* requirements for waterproof protection. However, once the transceiver has been dropped, or the waterproof seal is cracked or damaged, waterproof protection cannot be guaranteed because of possible damage to the case or the waterproof seal.

*The connectors on the rear panel do not meet IPX7.

If the front panel is exposed to saltwater, **BE SURE TO CLEAN IT THOROUGHLY WITH FRESH WATER** when the front panel's waterproof protection is effective. Otherwise, the keys and switch may become inoperable due to salt crystallization.

ACTION ICON DESCRIPTION

The following describes the [CH/ENT], [ENT] and the keypad operations in this instruction manual.

Rotate



: Rotate [CH/ENT] to select.

Push



: Push [ENT] to enter or set.

Push



: Push the keypad to enter a digit or text.

Also, you can use the following key functions in the Menu screen.

FUNCTION	ACTION
Select	Rotate [CH/ENT]. Push [▲] or [▼].
Enter	Push [ENT] or [CH/ENT].
Go to the next tree level	Push [ENT] or [▶].
Go back to the previous tree level	Push [CLR] or [◀].
Cancel	Push [CLR].
Exit	Push [MENU] or [Home] .

Icom is not responsible for the destruction, damage to, or performance of any Icom or non-Icom equipment, if the malfunction is because of:

- Force majeure, including, but not limited to, fires, earthquakes, storms, floods, lightning, other natural disasters, disturbances, riots, war, or radioactive contamination.
- The use of Icom transceivers with any equipment that is not manufactured or approved by Icom.

TABLE OF CONTENTS

IMPORTANT.....	i	■ DSC Task mode.....	33
EXPLICIT DEFINITIONS.....	i	■ Sending a Distress call.....	35
DISPOSAL.....	i	■ Sending a Non-Distress call.....	48
IN CASE OF EMERGENCY.....	ii	■ Receiving DSC calls.....	60
INSTALLATION NOTE.....	ii	■ Received Call log.....	75
PRECAUTIONS.....	iii	■ Transmitted Call log.....	76
ACTION ICON DESCRIPTION.....	iv	■ DSC settings.....	77
1 OPERATING RULES.....	1	9 MENU ITEMS.....	82
2 PANEL DESCRIPTION.....	2	■ Menu items.....	82
■ Front panel.....	2	■ GPS Information.....	83
■ Software Key function.....	5	■ Configuration settings.....	83
■ Microphone.....	5	■ Radio settings.....	90
■ Function display (Main screen).....	6	■ Radio Information.....	91
3 PREPARATION.....	9	10 CONNECTIONS AND MAINTENANCE.....	92
■ Entering the MMSI code.....	9	■ Connections.....	92
4 MENU SCREEN.....	10	■ Antenna.....	94
■ Construction.....	10	■ Fuse replacement.....	94
■ Selecting a Menu item.....	12	■ Cleaning.....	94
5 BASIC OPERATION.....	13	■ Supplied accessories.....	95
■ Selecting a channel.....	13	■ Power source connections.....	96
■ Setting the Call channel.....	14	■ Mounting the transceiver.....	97
■ Receiving and transmitting.....	15	■ Handset (HS-98).....	98
■ Backlight function.....	17	11 SPECIFICATIONS AND OPTIONS.....	99
■ Microphone Lock function.....	17	■ Specifications.....	99
■ Entering a Channel name.....	18	■ Dimensions.....	100
■ Bridge Alert Management (BAM).....	20	■ Options.....	100
6 SCAN OPERATION.....	26	12 TROUBLESHOOTING.....	101
■ Scan types.....	26	13 CHANNEL LIST.....	103
■ Favorite channels.....	27	14 DIGITAL INTERFACE (IEC61162-1).....	104
■ Starting a scan.....	27	■ I/O Sentences.....	104
7 DUALWATCH/TRI-WATCH.....	28	■ BAM Sentences.....	107
■ Description.....	28	■ Schematic diagram.....	110
■ Operation.....	28	■ Hardware version.....	110
8 DSC OPERATION.....	29	■ Software version.....	110
■ DSC address ID.....	29	15 BAM ALERTS.....	111
■ Entering the position and time.....	31	INDEX.....	116

◇ **Priorities**

- Read all rules and regulations pertaining to call priorities, and keep an up-to-date copy handy. Safety and distress calls take priority over all others.
- You must monitor Channel 16 when you are not operating on another channel.
- False or fraudulent distress calls are prohibited under law.

◇ **Privacy**

- Information overheard, but not intended for you, cannot lawfully be used in any way.
- Indecent or profane language is prohibited.

◇ **Radio licenses**

(1) SHIP STATION LICENSE

You may require a current radio station license before using the transceiver. It is unlawful to operate a ship station which is not licensed, but required to be.

If required, contact your dealer or the appropriate government agency for a Ship-Radiotelephone license application. This government-issued license states the call sign which is your craft's identification for radio purposes.

(2) OPERATOR'S LICENSE

A Restricted Radiotelephone Operator Permit is the license most often held by small vessel radio operators when a radio is not required for safety purposes.

If required, the Restricted Radiotelephone Operator Permit must be posted or kept with the operator. If required, only a licensed radio operator may operate a transceiver.

However, non-licensed individuals may talk over a transceiver if a licensed operator starts, supervises, ends the call and makes the necessary log entries.

A current copy of the applicable government rules and regulations is only required to be on hand for vessels in which a radio telephone is compulsory. However, even if you are not required to have these on hand it is your responsibility to be thoroughly acquainted with all pertinent rules and regulations.

■ Front panel

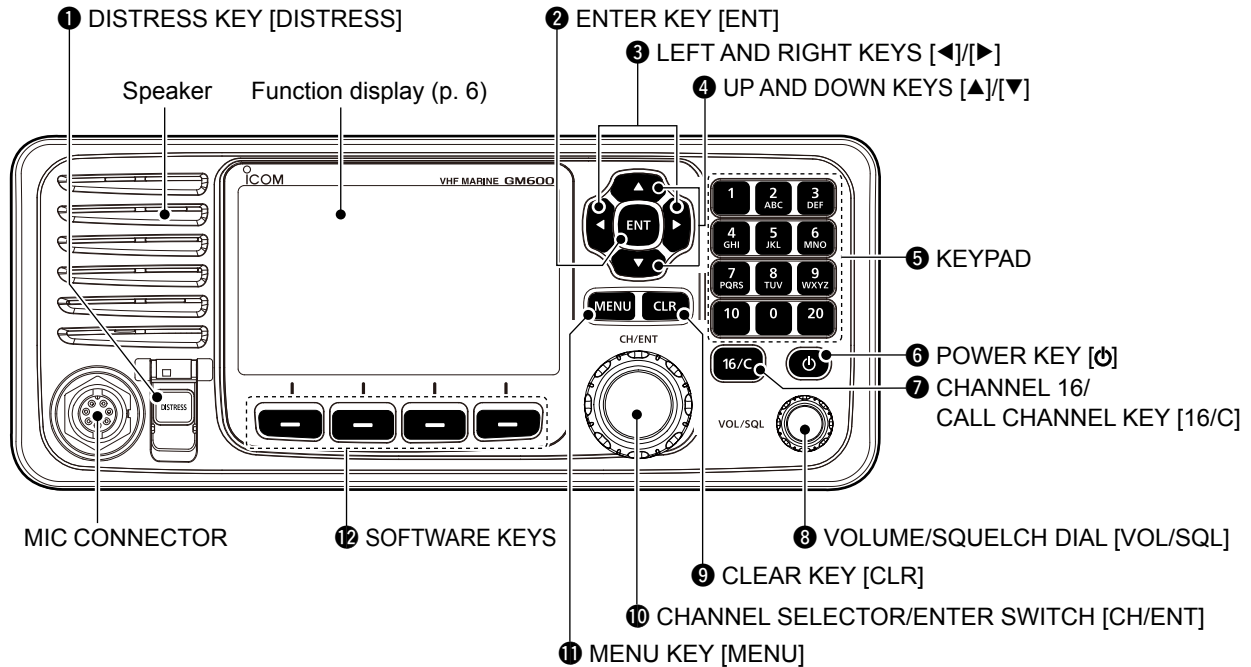

1 DISTRESS KEY [DISTRESS] (p. 35)

Hold down for 3 seconds to transmit a Distress call.

2 ENTER KEY [ENT]

Push to set the entered data, selected item, and so on.

3 LEFT AND RIGHT KEYS [◀]/[▶]

- Push to scroll the Software Key functions. (p. 5)
- In the character or number entry mode, push to select the desired character or number in the keypad. (p. 18)

4 UP AND DOWN/CHANNEL SELECT KEYS [▲]/[▼]

- Push to select the operating channel (p. 13), Menu items (p. 12), Menu settings (p. 12), and so on.
- While scanning, push to check the Favorite channels, change the scanning direction or manually resume a scan. (p. 27)

5 KEYPAD

Push to enter numbers, letters or symbols.
 For channel number entry, see page 13.
 For channel name entry, see page 18.

6 POWER KEY [⏻]

Hold down for 1 second to turn the transceiver ON or OFF.

7 CHANNEL 16/CALL CHANNEL KEY [16/C]

- Push to select Channel 16. (p. 13)
- Hold down for 1 second to select the Call channel. (p. 13)
 - “CALL” is displayed when the Call channel is selected.

8 VOLUME/SQUELCH DIAL [VOL/SQL] (p. 15)

- Rotate to adjust the volume level.
- Push once or twice to display the Volume or Squelch Setting screen, and then rotate to adjust the volume or squelch level.

9 CLEAR KEY [CLR]

Push to cancel the entered data, or to return to the previous screen.

10 CHANNEL SELECTOR/ENTER SWITCH [CH/ENT]

- Rotate to select the operating channel (p. 13), Menu items (p. 12), Menu settings (p. 12), and so on.
- Push to set the entered data, selected item, and so on. (p. 12)

11 MENU KEY [MENU]

Push to enter or exit the Menu screen. (p. 12)

2 PANEL DESCRIPTION

■ Front panel (Continued)

⑫ SOFTWARE KEYS (p. 5)

You can use various key functions that are assigned to the Software Keys, as described below.

Compose Distress* (p. 36)

Push to display the Compose Distress screen.

Compose Non-Distress* (p. 48)

Push to display the Compose Non-Distress screen.

Compose DROBOSE* (p. 42)

Push to display the Compose DROBOSE screen.

Task List (p. 34)

Push to display the Task List screen.

Scan (p. 27)

Push to start or stop a Normal or Priority scan.

Dualwatch/Tri-watch [Dual Watch] (p. 28)

Push to start or stop the Dualwatch or Tri-watch.

High/Low [HI/LO] (p. 15)

Push to set the output power level to high or low.

- Some channels are set to only low power.

Channel [CH] (p. 13)

When Channel 16 or the Call channel is selected, push to select the last selected channel.

Favorite channel [Favorite] (p. 27)

Push to set or clear the displayed channel as a Favorite channel.

Channel Name [CH Name] (p. 18)

Push to display the Channel Name screen.

Backlight (p. 17)

Push to open the Backlight Settings window.

DSC Log (p. 75)

Push to display the Received Call Log screen.

BAM List (p. 24)

Push to display the received alerts.

- When the BAM function is turned OFF, the BAM List is not displayed.

* These key functions are not displayed in the Radio Telephone (RT) mode. (p. 14)

■ Software Key function

The transceiver has the Software Keys for various functions. The key function is displayed above the Software Key, as shown below.

◇ Selecting the Software Key function

When “◀” or “▶” is displayed beside the key icon, pushing [◀] or [▶] scrolls the Software Key functions. When you push [◀] or [▶] once, 4 functions scroll together.

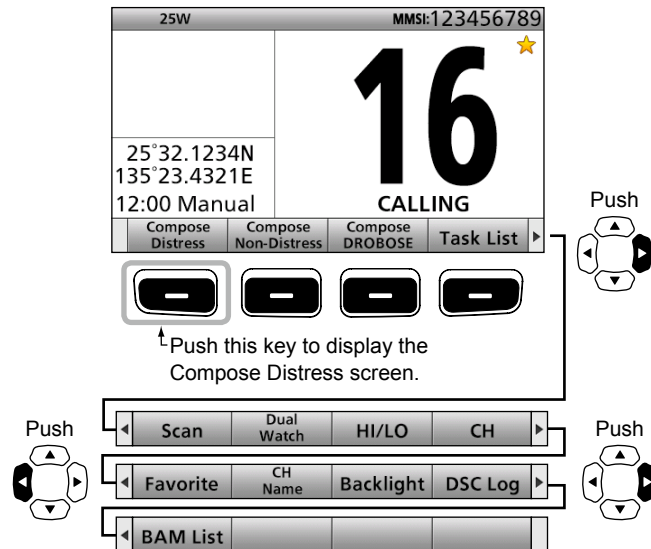

■ Microphone

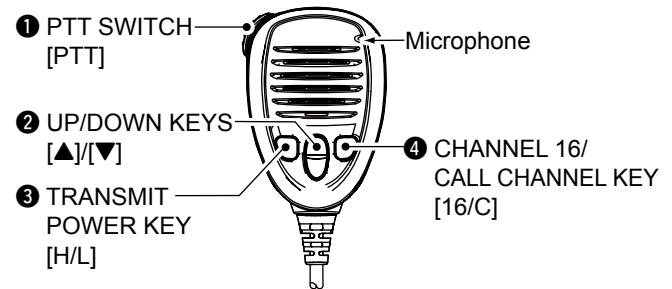

- 1 **PTT SWITCH [PTT]** (pp. 15, 35)
Hold down to transmit, release to receive.
- 2 **UP/DOWN KEYS [▲]/[▼]** (p. 27)
Push to select the Favorite channels, change scanning direction or manually resume a scan.
 - When the “FAV on MIC” item is set to “OFF,” you can select all channels. (p. 91)
- 3 **TRANSMIT POWER KEY [H/L]**
 - Push to set the power level to high or low. (p. 15)
 - Some channels are set to only low power.
 - While holding down this key, turn ON the transceiver to turn the Microphone Lock function ON or OFF. (p. 17)
- 4 **CHANNEL 16/CALL CHANNEL KEY [16/C]** (p. 13)
 - Push to select Channel 16.
 - Hold down for 1 second to select the Call channel.
 - The “CALL” icon is displayed.

2 PANEL DESCRIPTION

■ Function display (Main screen)

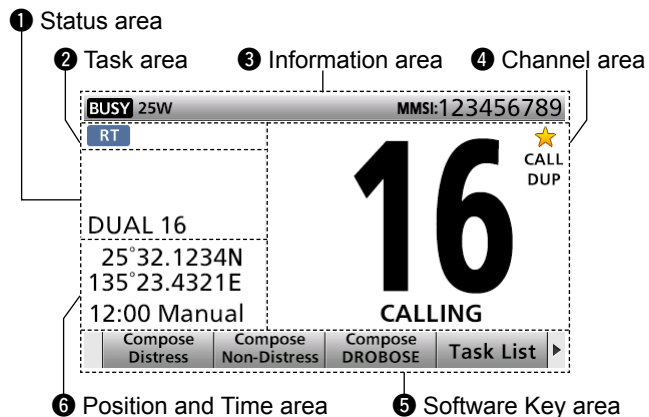

Display area	Description
1 Status area	Displays the current status.
2 Task area	Displays up to 7 task icons.
3 Information area	Displays various icons and the MMSI code.
4 Channel area	Displays the selected operating channel information. (p. 7)
5 Software Key area	Displays the key function for each Software Key. (p. 5)
6 Position and Time area	Displays the current position and time. (p. 8)

◇ Status area

The current status is displayed in the Status area.

Indicator	Description
SCAN 16	Displayed during a Priority scan. (p. 27)
SCAN	Displayed during a Normal scan. (p. 27)
DUAL 16	Displayed during Dualwatch. (p. 28)
TRI 16	Displayed during Tri-watch. (p. 28)







◇ Task area

Task icons are displayed in the Task area when the transceiver has tasks.

Indicator	Description
RT	<p>Displayed while in the Radio Telephone (RT) mode. (p. 14)</p> <ul style="list-style-type: none"> “RT” is displayed when the RT mode task is on hold. Returns to the Standby mode if no operation occurs during the preset period of time.
DSC (1)	<p>Displayed after making or receiving a DSC call. (p. 33)</p> <ul style="list-style-type: none"> “DSC (1)” is displayed when the DSC task is on hold. The number of DSC tasks is displayed by the indicator.

◇ **Information area**

The 9 digit MMSI (Maritime Mobile Service Identity: DSC self ID) code and the following indicators are displayed in the Information area.

Indicator	Description
	Displayed while receiving a signal or when the squelch is open.
	Displayed while transmitting.
25W	Displayed when high power is selected.
1W	Displayed when low power is selected.
	Displayed when the transceiver receives a valid GPS data from the GPS receiver. Blinks while invalid GPS data is being received.
	Displayed when there is an unread DSC message. Blinks when a DSC message is received.
SP-OFF	Displayed when the “Internal Speaker” item is OFF. (p. 89)
BAM-OFF	Displayed when the BAM function is OFF. (p. 22)
	Displayed when the BAM alert is received. • The icon varies, depending on the alert’s priority and status. (p. 23)
	Displayed when the “CH Auto Switch” in DSC settings is set to an option except “Accept after 10 sec..”

◇ **Channel area**

The selected operating channel number, channel name, and the following indicators are displayed in the Channel area.

Indicator	Description
	Displayed when a Favorite (Tag) channel is selected.
CALL	Displayed when the Call channel is selected.
DUP	Displayed when a Duplex channel is selected.

2 PANEL DESCRIPTION

■ Function display (Main screen) (Continued)

◇ Position and Time area

POSITION AREA

The current position is displayed when valid GPS data has been received, or the position was manually entered.

Indicator	Description
No Position	Displayed when a GPS receiver is not connected and your position has not been manually entered.
??	Blinks every 2 seconds instead of your position when the GPS position is invalid. <ul style="list-style-type: none">• The last position is held for only 23.5 hours. After that, "No Position" will be displayed.
	Blinks every 2 seconds instead of the position after 4 hours have passed since you manually entered your position. <ul style="list-style-type: none">• The manually entered position is held for only 23.5 hours. After that, "No Position" will be displayed.

TIME AREA

- ➔ The current time is displayed when valid GPS data has been received, or the time was manually entered.
- ➔ The date information is displayed when the RMC GPS sentence formats are included in the GPS signal.

Indicator	Description
No Time	Displayed when a GPS receiver is not connected and the time has not been manually entered.
Local	Displayed when the offset time is set.
Manual	Displayed when the time was manually entered.
UTC	Displayed when the GGA, GLL or GNS GPS sentence formats are included in the GPS signal.
??	Blinks every 2 seconds instead of the time when the GPS current time is invalid. <ul style="list-style-type: none">• After 23.5 hours has passed, "No Time" will be displayed.
	Blinks every 2 seconds instead of the time after 4 hours have passed since you manually entered the time. <ul style="list-style-type: none">• The manually entered time is held for only 23.5 hours. After that, "No Time" will be displayed.

■ Entering the MMSI code

First, you must enter the 9 digit MMSI (Maritime Mobile Service Identity: DSC self ID) code at power ON.

You can perform this initial code entry ONLY ONCE. After entry, only your dealer or distributor can change it. If you have already entered your MMSI code, these procedures are not necessary.

- ① Hold down [⏻] for 1 second to turn ON the transceiver.
 - Three short beeps sound.
 - “Push [ENT] to register your MMSI” is displayed.
- ② Push [ENT] to enter the MMSI code entry mode.

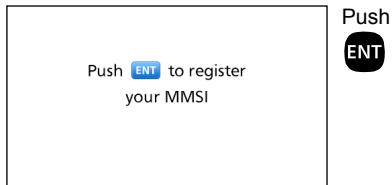

- Push [CLR] to cancel the entry. In that case, the transceiver displays “Push [ENT] to register your MMSI” again.

- ③ Enter your 9 digit MMSI code.

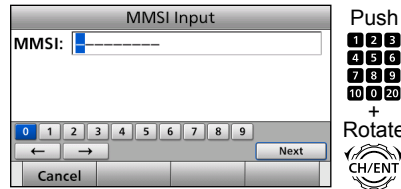

- ④ After entering the 9th digit, set the ID.

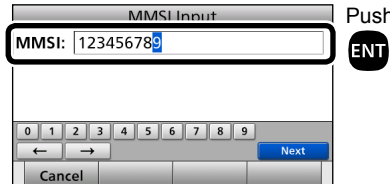

- ⑤ Reenter your MMSI code to confirm.

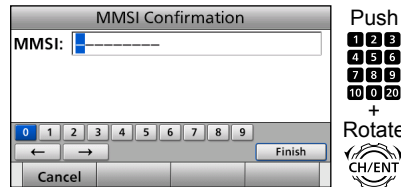

- ⑥ After entering the 9th digit, register the ID.

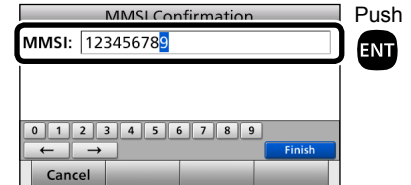

- When you successfully enter your MMSI code, the following screen is displayed.



- After that, the Main screen is displayed. The registered MMSI code is displayed at the top of the screen.

You can use the Menu screen to set infrequently changed values or function settings.

Construction

The Menu screen is constructed in a tree structure.

To select an item, rotate [CH/ENT].

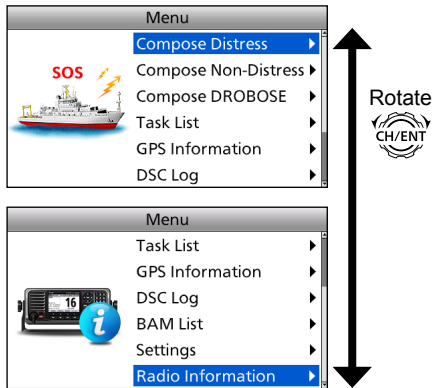

You can go to the next tree level by pushing [ENT], or go back a level by pushing [CLR].

See page iv for details.

• Compose Distress (p. 36)

Nature of Distress	Selects a Nature of Distress option.
Position	Enters your position.
• Latitude	Displays latitude data.
• Longitude	Displays longitude data.
• UTC	Displays UTC offset data.

• Compose Non-Distress (p. 48)

Message Type	Selects a Message Type option.
Address	Enters a destination address.
Category	Selects a Category option.
Position* ¹	Enters your position.
• Latitude* ¹	Displays latitude data.
• Longitude* ¹	Displays longitude data.
• UTC* ¹	Displays UTC offset data.
Mode* ¹	Selects a Mode option.
Channel* ¹	Selects an Intership channel.

• Compose DROBOSE (p. 42)

Message Type	Selects a Message Type option.
Distress ID	Enters a Distress ID.
Nature of Distress	Selects a Nature of Distress option.
Address* ¹	Enters a destination address.
Mode	Displays the communication mode.
Position	Enters your position.

• Latitude	Displays latitude data.
• Longitude	Displays longitude data.
• UTC	Displays UTC offset data.

• Task List (p. 34)

• GPS Information (p. 83)

• DSC Log (pp. 75, 76)

Received Call Log	
• Distress	Displays the received Distress call log.
• Others	Displays the received call log other than the Distress call.
Transmitted Call Log	Displays the transmitted call log.

• BAM List*³ (p. 24)

• Settings (p. 91)

Configuration	
• Display	Sets the Display settings.
• Key Beep	Turns the Key Beep function ON or OFF.
• Key Assignment	Assigns Software Key functions.
• UTC Offset	Sets the UTC Offset.
• Inactivity Timer	Sets the inactivity timer.
• Position Data Output	Selects a Position Data Output option.
• BAM	Sets the BAM function.

*1 These items may not be displayed, depending on the “Message Type” item’s option.

*2 This item is not displayed when valid GPS data is received.

• Internal Speaker	Turns the Internal Speaker function ON or OFF.
• MIC Type	Selects a microphone type.
Radio	
• Scan Type	Sets the Scan Type to Normal Scan or Priority Scan.
• Scan Timer	Turns the Scan Timer function ON or OFF.
• Dual/Tri-Watch	Selects the Dualwatch or Tri-watch function.
• Call Channel	Sets the Call channel.
• Favorite Channel	Sets the Favorite channel settings.
• FAV on MIC	Turns the FAV on MIC function ON or OFF.
• Channel Display	Selects the number of digits to display the channel number.
DSC	
• Position Input*2	Enters your position.
• Individual ID	Enters an Individual ID.
• Group ID	Enters a Group ID.
• Auto ACK	Selects an ACK option.
• Medical Transports	Turns the Medical Transports call ON or OFF.
• Ships and Aircraft	Turns the Ships and Aircraft call ON or OFF.
• CH Auto Switch	Sets the CH Auto Switch function.
• DSC Data Output	Selects a DSC Data Output option.

• CH 70 SQL Level	Selects the Channel 70 squelch level.
• Auto Print	Turns the Auto Print function ON or OFF.
• Self Check Test	Starts the Self Check Test.

• **Radio Information** (p. 91)

*3 This item is not displayed when the BAM function is turned ON. (p. 88)

4 MENU SCREEN

■ Selecting a Menu item

Follow the procedures as described below to select a Menu item.

Example: Sets the Tri-watch function.

- ① Push [MENU] to display the Menu screen.
- ② Rotate [CH/ENT] to select "Settings," then push [ENT].

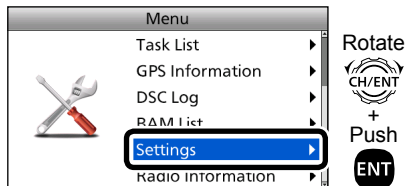

- ③ Rotate [CH/ENT] to select "Radio," then push [ENT].

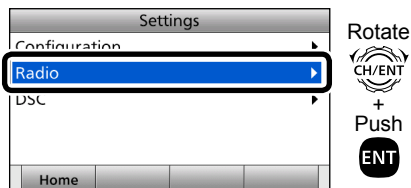

- ④ Rotate [CH/ENT] to select "Dual/Tri-Watch," then push [ENT].

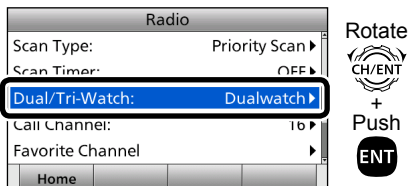

- ⑤ Rotate [CH/ENT] to select "Tri-Watch," then push [ENT].

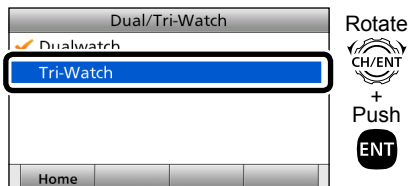

- Sets the Tri-watch function, and then goes back to the previous screen, after pushing [ENT].

- ⑥ Push [MENU] to return to the Main screen.

■ Selecting a channel

◇ Selecting a regular channel

Selecting a channel in sequence:

- ➔ Rotate [CH/ENT].
- ➔ Push [▲] or [▼].

Entering the desired channel number:

- ➔ Push the keypad to directly enter the desired channel number.

Example: Selecting Channel 22

Push [2 ABC] → [2 ABC], and then push [ENT] or [Set] .

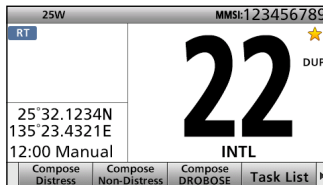

◇ Selecting Channel 16

Channel 16 is the distress and safety channel. It is used for establishing initial contact with a station, and for emergency communications. While standing by, you must monitor Channel 16.

- ➔ Push [16/C].

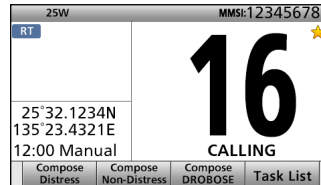

To recall the channel that was displayed before selecting Channel 16:

- ➔ Push [CH] .

◇ Selecting the Call channel

You can set a Call channel for quick recall.

To set your most used channel, see page 14.

The default Call channel is Channel 16.

- ➔ Hold down [16/C] for 1 second.

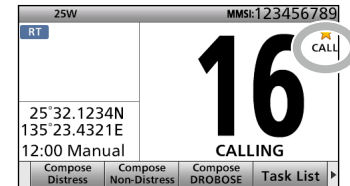

To recall the channel that was displayed before selecting the Call channel:

- ➔ Push [CH] .

5 BASIC OPERATION

■ Selecting a channel (Continued)

TIP: After receiving a signal, or you operate the transceiver, the transceiver enters the Radio Telephone (RT) mode. In the RT mode, you can make voice communications except for the DSC operation.

- “RT” is displayed while in the RT mode.
- “RT” is displayed when the RT mode task is on hold.
- “RT” or “RT” disappears (Returns to the Standby mode) if no operation occurs during the preset period of time. (p. 82)

■ Setting the Call channel

You can set the Call channel with your most often-used channel for quick recall.

- ① Push [MENU] to display the Menu screen.
- ② Rotate [CH/ENT] to select “Settings,” then push [ENT].

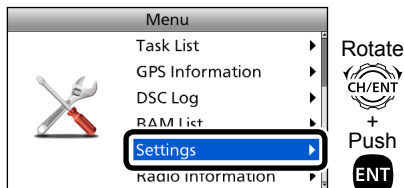

- ③ Rotate [CH/ENT] to select “Radio,” then push [ENT].

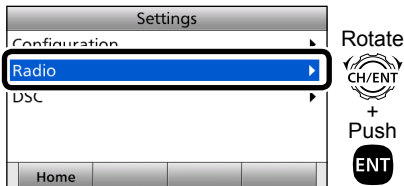

- ④ Rotate [CH/ENT] to select “Call Channel,” then push [ENT].

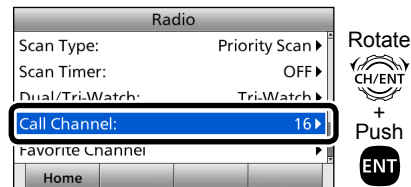

- ⑤ Rotate [CH/ENT] to select the desired channel to be set as the Call channel, then push [ENT].



- Goes back to the previous screen, after pushing [ENT].

- ⑥ Push [MENU] to return to the Main screen.

TIP: To confirm that your setting is correctly set, hold down [16/C] for 1 second. (p. 13)

■ Receiving and transmitting

CAUTION: DO NOT Transmit without an antenna.

- ① First, turn ON the PS-310 DC-DC POWER SUPPLY.
- ② Hold down [⏻] for 1 second to turn ON the transceiver.
 - If no MMSI code is entered, “Push [ENT] to register your MMSI” is displayed. (p. 9)
- ③ Rotate [VOL/SQL] to adjust the audio level.



- ④ Push [VOL/SQL] once or twice to open the SQL Setting window.



- ⑤ Rotate [VOL/SQL] to adjust the squelch level until the noise just disappears.
- ⑥ Select a channel. (p. 13)
- ⑦ Push [◀] or [▶] until Software Key function [HI/LO] is displayed.
- ⑧ Push [HI/LO]  to select an output power high or low.

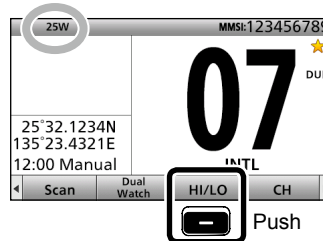

- ⑨ Hold down [PTT], and speak at your normal voice level.
 - “TX” is displayed.
- ⑩ Release [PTT] to return to receive.

NOTE:

Selecting a channel:

- While receiving a signal, “BUSY” is displayed.
- You can use Channel 70 only for Digital Selective Calling (DSC) transmissions.
- When the “FAV on MIC” item is set to “OFF,” you can select all channels using the [▲] or [▼] keys on the microphone. (p. 91)

Selecting an output power:

- “25W” is displayed when high power is selected. Choose high power for longer distance communications.
- “1W” is displayed when low power is selected. Choose low power for short range communications.
- Some channels are restricted to low power.

5 BASIC OPERATION

■ Receiving and transmitting (Continued)

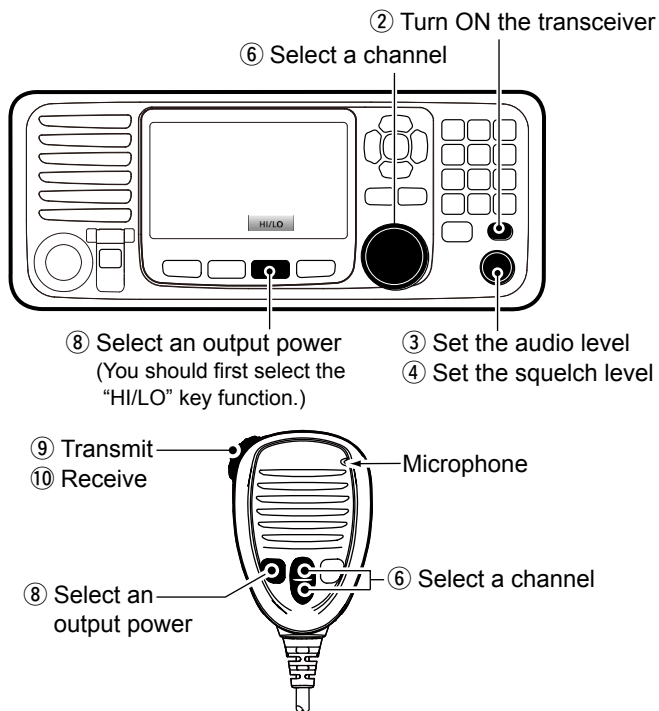

IMPORTANT: To maximize the readability of your transmitted signal at a receiver station, pause a second after pushing [PTT], and then hold the microphone 5 to 10 cm from your mouth and speak at your normal voice level.

NOTE for the Time-out Timer (TOT) function

The TOT function inhibits continuous transmission beyond a preset time period after the transmission starts. 10 seconds before transmission is cut off, a beep sounds to indicate the transmission will be cut off, and "TOT" is displayed in the channel name field. You cannot transmit again for 10 seconds after it is cut off.

■ Backlight function

The function display and keys can be backlit for better visibility under low light conditions.

And, you can set the Backlight mode to Day Mode, Night Mode, or Auto mode. Day Mode is for the daytime operation, and the screen items are in color.

Night Mode is for the nighttime operation, and the screen items are in black and red.

The Auto mode automatically changes the display mode to Night Mode while in Night Mode Time.

- ① Push [◀] or [▶] until the Software Key function [Backlight] is displayed.
- ② Push [Backlight]  to open the Backlight Settings window.

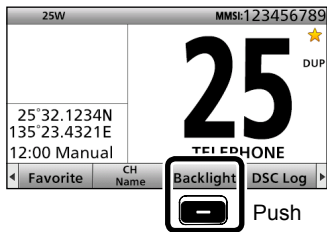

- In the Backlight Settings window, if you push no key for about 5 seconds, the transceiver automatically returns to the Normal operation mode.

- ③ Push [▲] or [▼] to select “Day Mode,” “Night Mode,” or “Auto.”

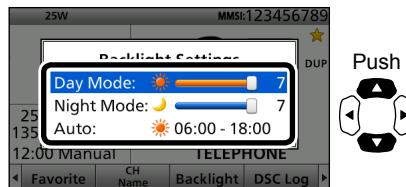

- ④ Rotate [CH/ENT] to adjust the backlight level, then push [ENT].

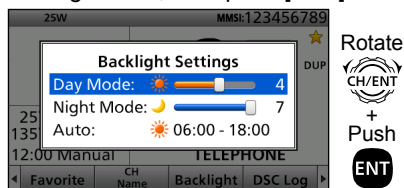

- The backlight level is adjustable in 7 levels and “OFF.”*
- *“OFF” is selectable only in Day Mode.

TIP: You can also set the Backlight mode in the “Display item.” (p. 83)

■ Microphone Lock function

The Microphone Lock function electrically locks [▲], [▼], [16/C], and [H/L] on the supplied microphone. This prevents accidental channel changes and function access.

- While holding down [H/L] on the microphone, hold down [Ⓞ] for 1 second to turn ON the transceiver.
 - The Microphone Lock function is turned ON or OFF.

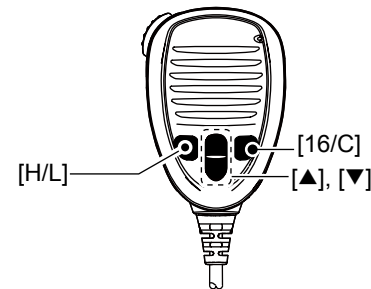

5 BASIC OPERATION

■ Entering a Channel name

You can rename each channel with a unique alphanumeric ID of up to 10 characters.

- ① First, cancel the Dualwatch, Tri-watch or Scan function, if activated.
- ② Rotate [CH/ENT] to select a channel.
- ③ Push [CH Name] .



- ④ Enter the desired character.

Using the keypad:

Push a keypad to enter a character.
(Example: Entering "S")



- To move the cursor, rotate [CH/ENT].
- You can enter the following characters by pushing the keypad one or more times.

KEY	ENTRY	KEY	ENTRY
[1]	1	[6]	6 M N O
[2]	2 A B C	[7]	7 P Q R S
[3]	3 D E F	[8]	8 T U V
[4]	4 G H I	[9]	9 W X Y Z
[5]	5 J K L	[0]	0 . (period)

Using [▲], [▼], [◀], or [▶]:

Push [▲], [▼], [◀], or [▶] to select the desired character. Then, push [ENT] to enter the character.
(Example: Entering "S")



- To move the cursor, push [▲], [▼], [◀], or [▶] to select either arrow, "←" or "→", then push [ENT].
- You can enter capital letters, 0 to 9, some symbols (! " # \$ % & ' () * + , - . / [\] ^ _ ; : < = > ?) and a space.

See 'Common operation' as described on page 19 for details of the following operations.

- Entering a symbol/space
- Deleting a character
- Canceling an entry
- Correcting an entry

Common operation

- **To enter a symbol:**
Select “!\$?,” and then push [ENT].
Push [▲], [▼], [◀], or [▶] to select the desired character, and then push [ENT].
 - **To enter a space:**
Push [▲], [▼], [◀], or [▶] to select “Space,” and then push [ENT].
 - **To delete a character:**
Push [▲], [▼], [◀], or [▶] to select “Delete,” and then push [ENT].
 - **To cancel an entry:**
Push [CLR].
 - **To correct an entry:**
Move the cursor to the character you want to change, and then enter the correct character.
- ⑤ Repeat step ④ to enter all characters.
- ⑥ Push [▲], [▼], [◀], or [▶] to select “Finish,” then push [ENT].
- Returns to the previous screen.
 - During keypad operation, “Finish” is automatically selected.

■ Bridge Alert Management (BAM)

Bridge Alert Management (BAM) is the overall concept that the IMO defined for management, handling and harmonized presentation of alerts on the bridge, to enable the bridge team to devote full attention to the safe operation of the ship and to immediately identify any alert situation requiring action to maintain the safe operation of the ship.

NOTE: The BAM has optional “Functional grouping” and “Aggregation” functions, but the GM600 cannot use these functions.

The transceiver can transmit and receive BAM sentences through the IEC61162-1 interface. There are two interfaces, one for transmit and one for receive.

When an event related to the BAM concept occurs, you can receive an alert from the transceiver. (p. 21)
You can check alerts in the BAM list. (p. 24)

When an alert is received:

- An icon is displayed or blinks in the information area.
- A popup screen is displayed with the icon.





- A popup screen may not be displayed, depending on the presetting.
- Two short beeps may sound, depending on the priority of the alert or the presetting.
- If you do not confirm the alert, two short beeps sound every 90 seconds. (Only for the alerts with the priority of “Warning.”)
- See page 23 for details of the icon.
- The icon on the popup screen may change, depending on the alert status.
- When there is more than one alert, the icon with the highest priority alert is displayed in the information area.

Example (Receiving a Distress Call):



You can receive the following alerts from the transceiver.

- See page 111 for details of the alerts.
- See page 22 for details of the category and priority.

Category	Priority	Event	Popup screen
B	Warning	<ul style="list-style-type: none"> • A Distress call is received. • A DSC call whose category is "Urgency" is received. 	See "DSC OPERATION." (p. 29)
	Caution	A DSC call is received that is other than a Distress call, or a DSC call whose category is "Urgency."	See "DSC OPERATION." (p. 29)
	Caution	The position data is invalid.	 Position data is not updating. Enter your position and time.
	Caution	<ul style="list-style-type: none"> • 4 hours have passed after you manually entered the position and time. • 23.5 hours have passed after you manually entered the position and time. 	 4 hrs have elapsed since you entered position. Enter your position and time.
			 23.5 hrs have elapsed since you entered position. Enter your position and time.
	Warning	The transceiver's Phase Lock Loop is unlocked.	 The transceiver cannot receive or transmit. Contact your dealer.
Caution	The DSC task is full. (The transceiver holds 7 tasks.)	 Task memory is full. Delete unnecessary tasks.	

5 BASIC OPERATION

■ Bridge Alert Management (BAM) (Continued)

◇ Turning ON the BAM function

- ① Push [MENU].
- ② Select “Function,” and then push [ENT]. (p. 88)
(Settings > Configuration > BAM > Function)
- ③ Select “ON,” and then push [ENT].

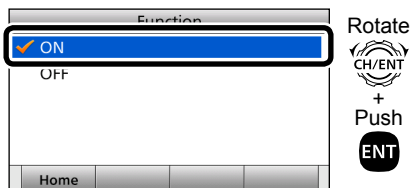

- ④ Push [MENU] to return to the Main screen.

◇ Category

The BAM concept has 3 categories, A, B, and C. You can receive category B alerts.

- B: Alert where no additional information for decision support is necessary besides the information that can be presented at the central alert management (CAM) HMI.

◇ Priority

The alerts are classified into 4 priorities, Emergency Alarm, Alarm, Warning, and Caution. You can receive alerts of the “Warning” and “Caution” priorities.

- Warning: A condition requiring immediate attention, but no immediate action by the bridge team. Warnings are presented for precautionary reasons to make the bridge team aware of changed conditions that are not immediately hazardous, but may become so if no action is taken.
- Caution: The lowest priority alert. Awareness of a condition that does not warrant an alarm or warning condition, but still requires attention out of the ordinary consideration of the situation or of given information.

◇ Responsibility transfer

The Central Alert Management (CAM) is the system that centrally manages alerts from multiple bridge equipment. The GM600 can be connected to the CAM system.

If the CAM system has additional knowledge regarding an alert situation, which caused the GM600 to raise an alert, it may apply for responsibility transfer.

This will reduce the number of high-priority audible alerts for one situation that requires attention.

In that case, the CAM system will follow the following procedures:

- If practicable, raise a new alert with a lower priority.
- Request the GM600 to accept the transfer of the responsibility for the alert that is raised to report the situation requiring attention.

When the GM600 receives a request for responsibility transfer from the CAM system:







- The alert status becomes “Active – Responsibility Transferred.”
- No alarms sound.
- The alert is not displayed on the BAM list by default.

NOTE: The GM600 can receive the request for responsibility transfer only while receiving a valid HBT sentence from the CAM system.

- See page 111 for the details of the BAM alerts that the CAM system may apply for responsibility transfer.

◇ Icon and Status

The icon varies, depending on the alert’s priority and status, as shown below.

Priority	Icon	Status	Description	Audible signal
Warning		Active – Unacknowledged	Alert condition is still present. Alert not acknowledged.	Yes
		Active – Silenced	Alert condition is still present. Alert not acknowledged but audible signals have been silenced by the operator.	No
		Active – Acknowledged	Alert condition is still present. Alert acknowledged by the operator.	
		Active – Responsibility Transferred	Alert condition is still present. A function of the BAM compliant equipment with additional system knowledge has taken over.	
		Rectified – Unacknowledged	Alert condition rectified. Alert still unacknowledged.	
	None	Normal	No alert condition present.	
Caution		Active	Alert condition is present.	No
	None	Normal	No alert condition is present.	

5 BASIC OPERATION

■ Bridge Alert Management (BAM) (Continued)

◇ BAM List

The BAM List screen displays the received alerts. When the alert status changes to “Normal,” the alert disappears from the list.

The alerts are sorted by priority, and the highest priority alert is located at the top of the list.

When there are alerts with the same priority, the newest alert is displayed at the top of the list.

NOTE: When the BAM function is turned OFF, the BAM List is not displayed on the Menu screen. (pp. 10, 82)

- ① Push [MENU].
- ② Select “BAM List,” and then push [ENT].

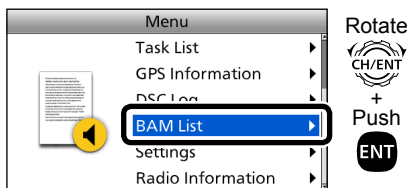

TIP: You can also enter the BAM List screen by holding down [CH/ENT] for 1 second on the Main screen.

- ③ Select an alert.
 - The alert whose status is “Active – Responsibility Transferred” is not displayed by default.
- ④ Push the Software Key for your next operation. (p. 25)

BAM List screen

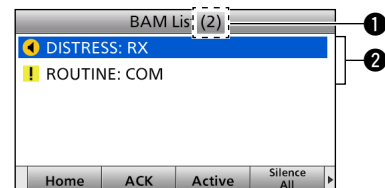

① THE NUMBER OF ALERTS

Displays the number of the received alerts.

② ALERTS INFORMATION

Displays the icon and title of the alert.

About the details screen

The details screen displays the selected alert's title, description, priority, and category.

◇ **Software Key functions**

When entering the BAM List screen, the following functions are displayed.

Function	Description
Home	Push to return to the Main screen.
ACK	Push to confirm an alert. <ul style="list-style-type: none"> • When an unrelated alert is selected, the key is disabled, and an error beep sounds.
Active	Push to activate the received call. <ul style="list-style-type: none"> • When an unrelated alert is selected, the key is disabled, and an error beep sounds.
Silence All	Push to mute for 30 seconds, all alerts that the transceiver has received. <ul style="list-style-type: none"> • The key is disabled, and an error beep sounds when: <ul style="list-style-type: none"> - There are no related alerts. - The alerts are already muted.

Function	Description
Top	Push to return to the first page and select the alert that has the highest priority.
Details	Push to display the details of the selected alert.
Show RESP transferred (Show responsibility transferred)	Push to display the alert that the status is "Active – Responsibility Transferred." <ul style="list-style-type: none"> • Displayed only when the alert that the status is "Active – Responsibility Transferred" is not displayed.
Hide RESP transferred (Hide responsibility transferred)	Push to hide the alert that the status is "Active – Responsibility Transferred." <ul style="list-style-type: none"> • Displayed only when the alert that the status is "Active – Responsibility Transferred" is displayed.

When entering the details screen of the selected alert by pushing [Details] , the following functions are displayed.

Function	Description
Home	Push to return to the Main screen.
ACK	Push to confirm an alert. <ul style="list-style-type: none"> • Displayed only when the priority of the selected alert is "Warning."
Active	Push to activate the received call. <ul style="list-style-type: none"> • Displayed only when the selected alert is related to receiving a DSC call.

■ Scan types

You can find ongoing calls by scanning the Favorite channels without rotating [CH/ENT].

The GM600 has two scan types.

- Priority scan (default)
- Normal scan

PRIORITY SCAN

A Priority scan sequentially searches all Favorite channels while also monitoring Channel 16.

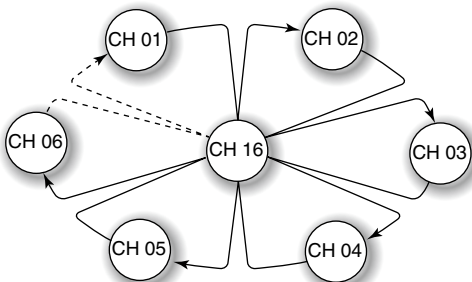

When a signal is received:

• On Channel 16

The scan pauses until the signal on Channel 16 disappears.

• On a channel other than Channel 16:

The scan switches to Dualwatch, until the signal disappears.

Before you start a scan:

- Set the desired channels you want to scan as Favorite channels. (Scans only Favorite channels.) (p. 27)
- Set the desired scan type to "Normal" or "Priority." (p. 90)

NORMAL SCAN

A Normal scan sequentially searches all Favorite channels. However, the scan does not check Channel 16 unless it is set as a Favorite channel.

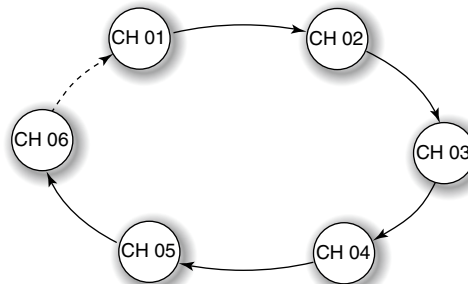

Favorite channels

You can quickly recall often-used channels by setting them as Favorite channels.

All channels are set as Favorite channels by default.

◇ Setting

- ① Rotate [CH/ENT] to select a channel.
- ② Push [Favorite]  to set the channel as a Favorite channel.
 - “★” is displayed.

◇ Selecting

- ➔ Push [▲] or [▼] on the microphone.
 - Non-Favorite channels are skipped and not displayed.
 - When the “FAV on MIC” item is set to “OFF,” you can select all channels. (p. 91)



TIP: You can select all channels by rotating [CH/ENT] or pushing [▲] or [▼] on the transceiver. (p. 13)

◇ Clearing

- ① Select a Favorite channel to clear.
- ② Push [Favorite]  to clear the channel as the Favorite channel.
 - “★” disappears.

TIP: You can clear all Favorite channels in the Menu screen. (p. 91)

Starting a scan

- ① Push [Scan]  to start a scan.
 - During a Priority scan, “SCAN 16” is displayed.
 - During a Normal scan, “SCAN” is displayed.
- ② Push [Scan]  again to cancel the scan.
 - “SCAN 16” or “SCAN” disappears.

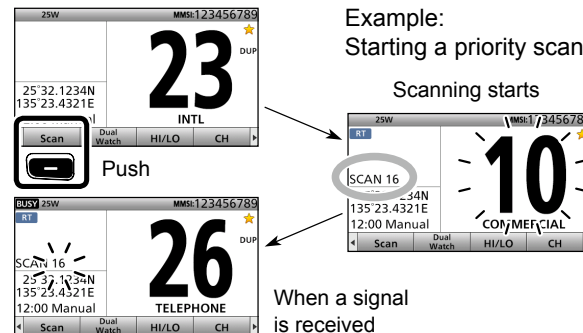

NOTE:



- When a signal is received, the scan pauses until the signal disappears, or resumes after pausing for 5 seconds, depending on the “Scan Timer” setting. (p. 90)
- You can check the scanning channel, change the scan direction, or manually resume the scan by pushing [▲] or [▼] on either the transceiver or the microphone.
- A beep tone sounds and “16” blinks when a signal is received on Channel 16 during a Priority scan.
- In order to properly receive signals, you must adjust the squelch to the proper level. (p. 15)

■ Description

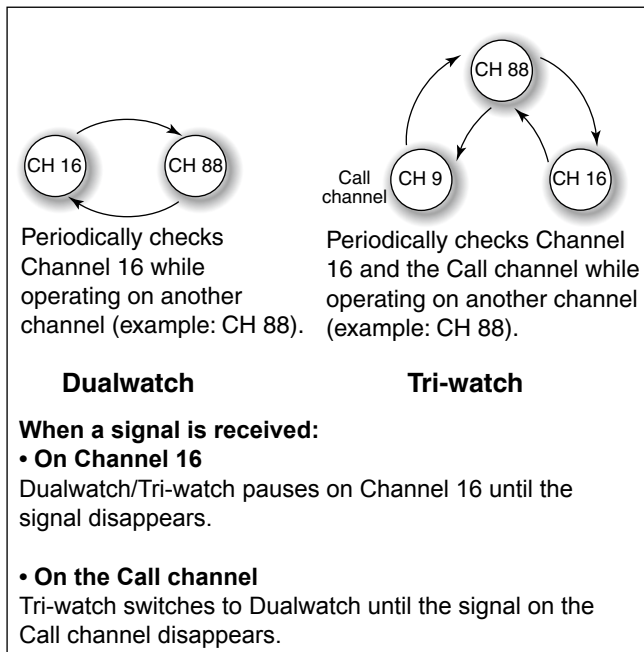
Dualwatch and Tri-watch are convenient to periodically check Channel 16 while you are operating on another channel.



■ Operation

- ① Select Dualwatch or Tri-watch in the Menu screen. (p. 90)
- ② Select a channel. (p. 13)
- ③ Push [Dual Watch] or [Tri Watch]  to start Dualwatch or Tri-watch.
 - During Dualwatch, "DUAL 16" is displayed.
 - During Tri-watch, "TRI 16" is displayed.
 - A beep tone sounds and "16" starts to blink when a signal is received on Channel 16.
- ④ Push [Dual Watch] or [Tri Watch]  again to cancel Dualwatch or Tri-watch.

Example: Operating Dualwatch on Channel 07.

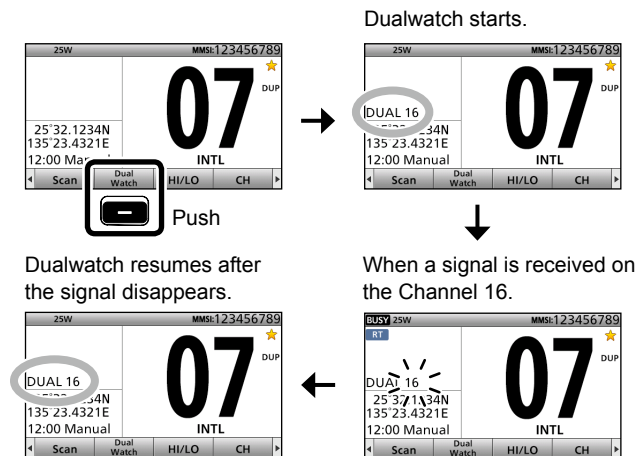

■ DSC address ID

You can enter a total of 100 DSC address IDs (Individual ID: 75, Group ID: 25), and assign a name of up to 10 characters.

◇ Entering Individual ID

- ① Push [MENU].
- ② Select “Individual ID,” then push [ENT].
(Settings > DSC > Individual ID)
- ③ Push [Add] .

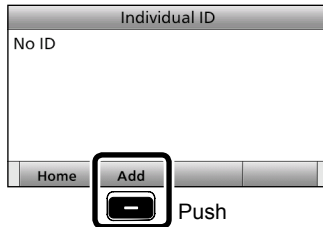

- ④ Enter a 9 digit Individual ID.

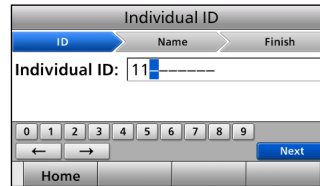

TIP: You must set the first digit for the Individual ID to between ‘1’ and ‘9.’

- The first digit must be set to ‘0’ for a Group ID.
- The first two digits must be set to ‘0’ for any Coast station ID.

- ⑤ After entering all 9 digits, select “Next,” and then push [ENT].
- ⑥ Enter the desired ID name.

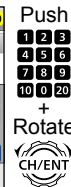
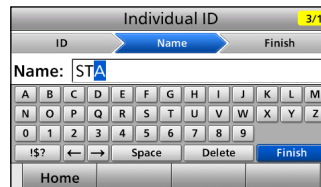

• See page 18 for text entry details.

- ⑦ After entering, select “Finish,” and then push [ENT].

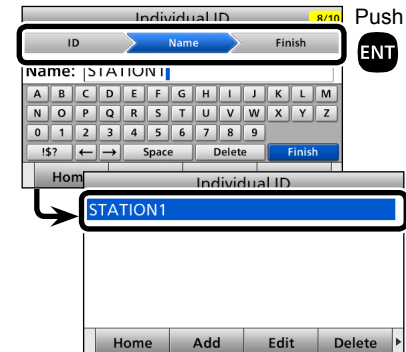

- The entered Individual ID and name are added to the ID list.
- ⑧ Push [MENU] to return to the Main screen.

8 DSC OPERATION

■ DSC address ID (Continued)

◇ Entering Group ID

- ① Push [MENU].
- ② Select "Group ID," then push [ENT].
(Settings > DSC > **Group ID**)
- ③ Push [Add] .

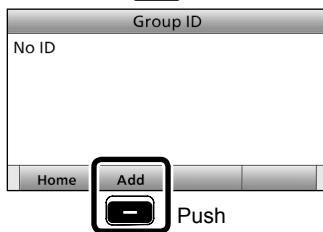

Push

- ④ Enter a 9 digit Group ID.

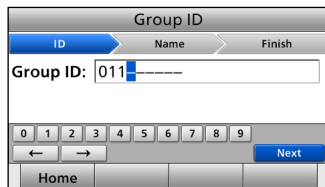

Push
1 2 3
4 5 6
7 8 9
10 0 20

+
Rotate
CH/ENT

TIP: You must set the first digit for a Group ID to '0.'

- The first digit must be set to between '1' and '9' for an Individual ID.
- The first two digits must be set to '0' for any Coast station ID.

- ⑤ After entering all 9 digits, select "Next," and then push [ENT].
- ⑥ Enter the desired ID name.



Push
1 2 3
4 5 6
7 8 9
10 0 20
+
Rotate
CH/ENT

• See page 18 for text entry details.

- ⑦ After entering, select "Finish," and then push [ENT].

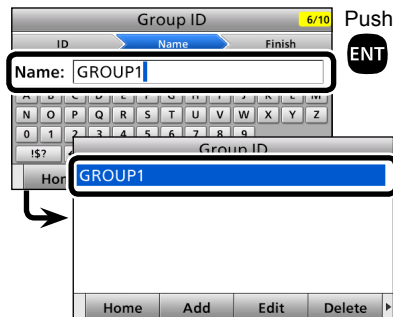

• The entered Group ID and name are added to the ID list.

- ⑧ Push [MENU] to return to the Main screen.

◇ Deleting an entered ID

- ① Push [MENU].
- ② Select "Individual ID" or "Group ID," then push [ENT].
(Settings > DSC > **Individual ID**)
(Settings > DSC > **Group ID**)
- ③ Rotate [CH/ENT] to select the ID to delete.
- ④ Push [Delete] .

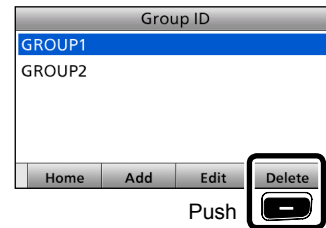

Push

- ⑤ Push [OK] .

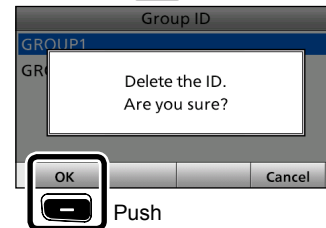

Push

• After deleting, returns to the ID list screen.

- ⑥ Push [MENU] to return to the Main screen.

■ Entering the position and time

A Distress call should include the ship's position and time.

If no GPS data is received, you should manually enter your position (latitude and longitude) and Universal Time Coordinated (UTC) time.

When a GPS receiver compatible with the IEC61162-1: 2000 format is connected, position and UTC time are automatically included.

- Manual entry is disabled when a valid GPS data is received.
- Manually entered position and time are valid for only 23.5 hours.

- ① Push [MENU].
- ② Select "Position Input," then push [ENT].
(Settings > DSC > **Position Input**)

- ③ Enter your latitude position.

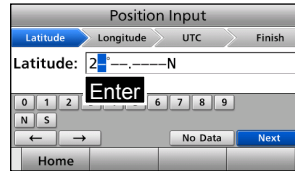

Push
1 2 3
4 5 6
7 8 9
10 0 20

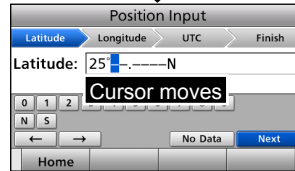

Rotate
CH/ENT

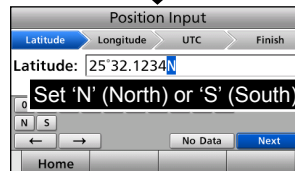

Push
1 2 3
4 5 6
7 8 9
10 0 20
(any key)

- ④ After entering, select "Next," and then push [ENT].
- To select 'N' (North latitude) or 'S' (South latitude), push any keypad key when the cursor is on the 'N' or 'S' position.

- ⑤ Enter your longitude position.

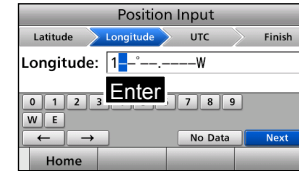

Push
1 2 3
4 5 6
7 8 9
10 0 20

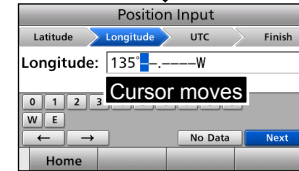

Rotate
CH/ENT

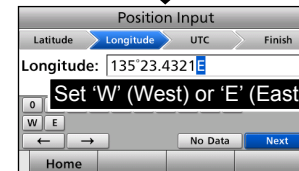

Push
1 2 3
4 5 6
7 8 9
10 0 20
(any key)

- ⑥ After entering, select "Next," and then push [ENT].
- To select W (West longitude) or E (East longitude), push any keypad key when the cursor is on the 'W' or 'E' position.

8 DSC OPERATION

■ Entering the position and time (Continued)

⑦ Enter your UTC time.

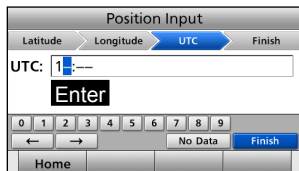

Push
 1 2 3
 4 5 6
 7 8 9
 10 0 20

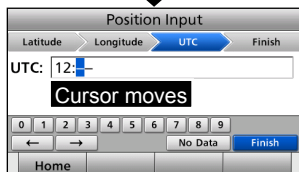

Rotate

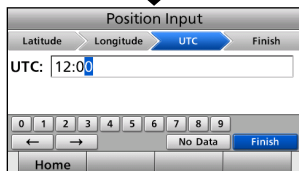

Push
 1 2 3
 4 5 6
 7 8 9
 10 0 20
 (any key)

⑧ After entering, select “Finish,” and then push [ENT].

- The DSC screen is displayed.

⑨ Push [MENU] to return to the Main screen.

When position and time data are set, Latitude, Longitude and UTC time are displayed.

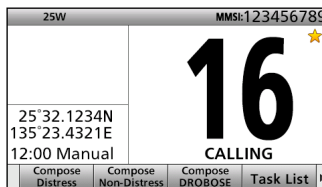

- Latitude: 25°32.1234N
- Longitude: 135°23.4321E
- UTC time: 12:00

When no position and time data are set, “No Position” and “No Time” are displayed.

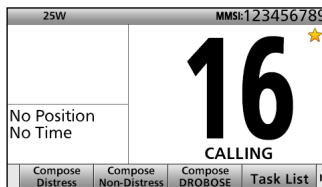

NOTE:

While entering:

- To move the cursor: Rotate [CH/ENT].
- To correct the entry: Move the cursor to the character. And then, enter the correct character.
- To clear the entry: Push [▲], [▼], [◀], or [▶] to select “No Data.” And then push [ENT]. When the following screen is displayed, push [OK] .

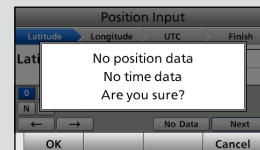

- To return to the Main screen: Push [Home] .
- To go back to the previous screen: Push [CLR].

■ DSC Task mode



The transceiver can hold up to 7 tasks. You can handle more than 2 DSC tasks simultaneously by switching between the tasks.

NOTE: The Task mode has a Time-out Timer (TOT) function. After a certain period of time has passed without any operation on a task, the transceiver automatically deletes a task and returns to the operating screen. When a Time-out Timer activates, an alarm sounds and a count down message is displayed for 10 seconds.

In the Task mode, you can hold or activate the DSC task as follows.



Example (When a Group call is received):

◇ Holding a DSC task

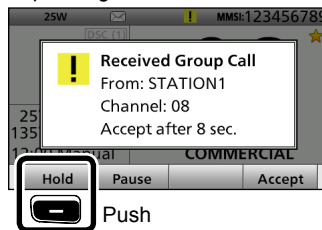
- ① Push any [Close]  to turn OFF the alarm.
 - When the BAM function (p. 20) is OFF: Push any [Alarm OFF] .
 - The received call's information is displayed.
- ② Push [Hold] .
 - The received Group call task is held into the Task List, and returns to the operating screen.



◇ Activating the held DSC task

- ① Push [Task List]  to display the Task List.
 - The Task List is displayed.
- ② Select the task that you want to activate.
- ③ Push [Active]  to activate the task.

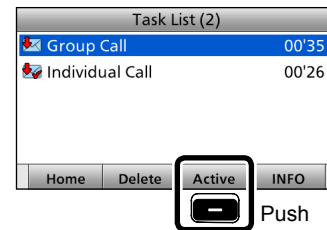

- The activated task information is displayed.
- ④ Push [PTT] to communicate.

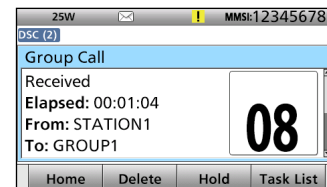

- ⑤ After finishing the communication, push [Delete]  to delete the task.

8 DSC OPERATION

■ DSC Task mode (Continued)

◇ Task List

You can display the Task List screen by pushing [Task List] .

The number of tasks is displayed at the top of the screen.

The number of tasks

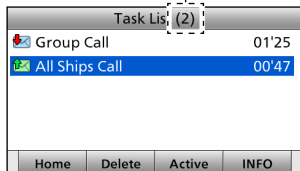

The DSC calls received from MOB devices (MOB task) are displayed as “MOB,” and you can check each MOB device in the Devices List.

See “Devices List” for details.

The number of MOB devices is displayed next to “MOB.”

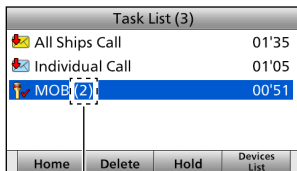

The number of MOB devices

On the Task List screen, the following Software keys are displayed.

FUNCTION	DESCRIPTION
Home	Push to hold the task and return to the Main screen.
Delete	Push to delete the selected task.
Hold	Push to hold the selected task.
Active	Push to activate the selected task.
INFO	Push to display the task information. • Displayed only when a DSC task is selected.
Devices List	Push to display the Devices List screen. • Displayed only when a MOB task is selected.

◇ Devices List

You can display the Devices List screen by pushing [Devices List]  when a MOB task is selected in the Task List.

The number of MOB devices is displayed at the top of the screen. The transceiver can hold up to 20 MOB devices.

The number of MOB devices

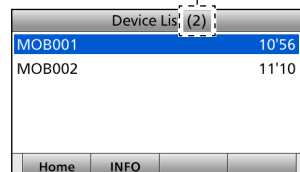

On the Devices List screen, the following Software keys are displayed.

FUNCTION	DESCRIPTION
Home	Push to hold the MOB task and return to the Main screen.
INFO	Push to display the MOB device information.
Relay	Push to send a Distress Relay call. (p. 61) • Displayed when a Distress call is received.
ACK	Push to send an acknowledgement. (pp. 41, 47) • Displayed when a Distress call or a Distress Relay call is received.

■ Sending a Distress call

NEVER MAKE A DISTRESS CALL IF YOUR SHIP OR A PERSON IS NOT IN AN EMERGENCY. A DISTRESS CALL SHOULD BE MADE ONLY WHEN IMMEDIATE HELP IS NEEDED.

You should send a Distress call if, in the opinion of the Master, the ship or a person is in distress and requires immediate assistance.

- Emergency channel (Channel 70) is automatically selected to send a Distress call.

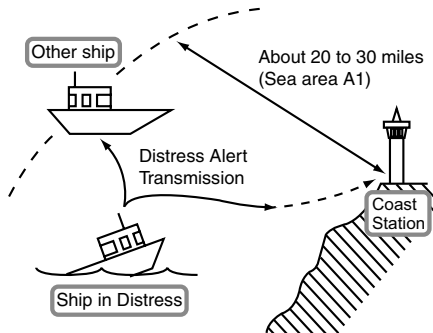

See **NOTE** on page 37 for a Distress call.

TIP: If you want to compose a Distress call, see 'Regular call.' (p. 36)

◇ Simple call

- ① Confirm no Distress call is being received.
- ② Lift up the key cover, then hold down [DISTRESS] until "Transmitting" is displayed to send the Distress call.
 - While holding down [DISTRESS], count down beeps sound and both the key and display backlighting blink.

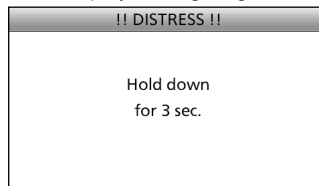

- ③ After sending, the following screen is displayed.

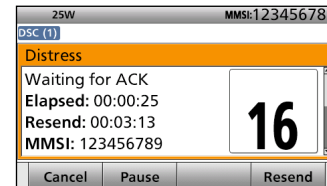

- Channel 16 is automatically selected.

- ④ When receiving the acknowledgment:
 - An alarm sounds.
 - The following screen is displayed.

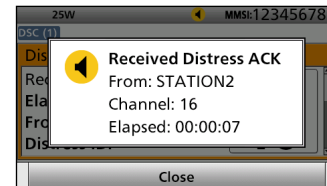

- ⑤ Push any [Close] .
 - When the BAM function (p. 20) is OFF: Push any [Alarm OFF] , and then push any [Close Call RCVD Window] .
- ⑥ Hold down [PTT] to announce your situation.
- ⑦ Push [Home] to return to the Main screen.

8 DSC OPERATION

■ Sending a Distress call (Continued)

◇ Regular call

You can compose the Distress call.

Step 1. Display the Compose Distress screen

- ① Push [Compose Distress] 

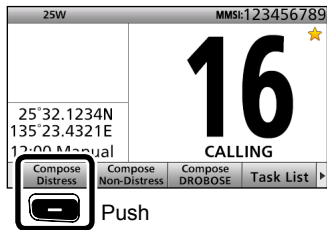

- To display the screen from the Menu screen:
([MENU] > **Compose Distress**)

Step 2. Setting “Nature of Distress”

- ① Push [ENT].

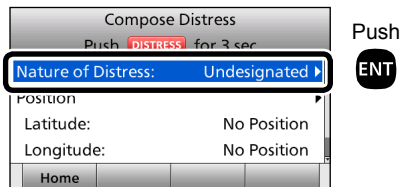

- ② Select the desired option, then push [ENT].
(Example: Fire, Explosion)

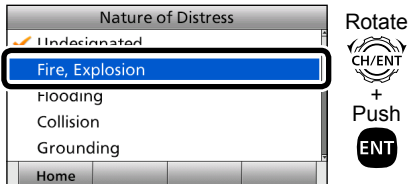

Options:

- Undesignated, Fire, Explosion, Flooding, Collision, Grounding, Capsizing, Sinking, Adrift, Abandoning Ship, Piracy, and Man Overboard.
- The transceiver stores this setting for 30 seconds.

You can skip Step 3 below if your position and time data are valid. In that case, go to Step 4.

Step 3. Entering “Position”

- ① Select “Position,” then push [ENT].
- The position entry screen is displayed.
- ② Enter your position and time data.
- See page 31 for entering details.

- ③ After entering, select “Finish,” and then push [ENT].

Step 4. Sending

- ① Lift up the key cover, then hold down [DISTRESS] until “Transmitting” is displayed to send the Distress call.
- While holding down [DISTRESS], count down beeps sound and both the key and display backlighting blink.

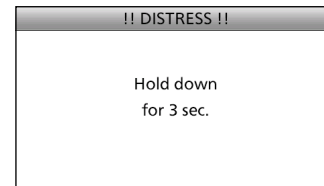

- ② After sending, the following screen is displayed.

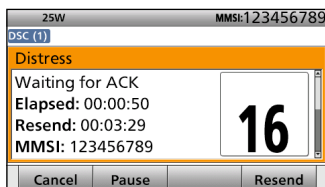



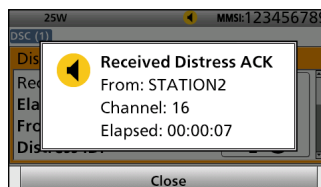

- Channel 16 is automatically selected.

Step 5. Replying

- ① When the acknowledgment is received:
- An alarm sounds.
 - The following screen is displayed.





- ② Push any [Close] .
- When the BAM function (p. 20) is OFF: Push any [Alarm OFF] , and then push any [Close Call RCVD Window] .
- ③ Hold down [PTT] to announce your situation.
- ④ Push [Home]  to return to the Main screen.

NOTE:

Transmitting:

- A distress alert default contains:
 - Nature of distress: Undesignated distress (Simple call) Selected in Step 2 (Regular call)
 - Position information: The latest GPS or manual input position is held for 23.5 hours, or until the power is turned OFF.

Waiting for an acknowledgment:

- The transceiver automatically sends a Distress call every 3.5 to 4.5 minutes, until receiving an acknowledgment ('Call repeat' mode), or sending a DSC Cancel call. (p. 39)
- To pause the 'Call repeat' mode: Push [Pause] .
- To resume it: Push [Resume Countdown] .
- To manually send a Distress Repeat call: Push [Resend] .
- To view the call contents: Rotate [CH/ENT].

8 DSC OPERATION

■ Sending a Distress call (Continued)

◇ Resending a Distress call

While waiting for an acknowledgment, you can resend the call. (Repeat call)

- ① When “Waiting for ACK” is displayed, push [Resend] .

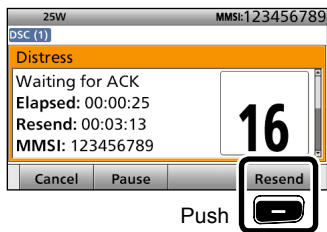

Push

You can skip Step ② ~ ④ below if your position and time data are valid. In that case, go to Step ⑤.

- ② Select “Position,” then push [ENT].
• The position entry screen is displayed.

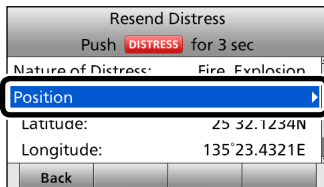

Push







- ③ Enter your position and time data.
• See page 31 for entering details.
- ④ After entering, select “Finish,” and then push [ENT].
- ⑤ Lift up the key cover, then hold down [DISTRESS] until “Retransmitting” is displayed to resend the call.
• While holding down [DISTRESS], count down beeps sound and both the key and display backlighting blink.

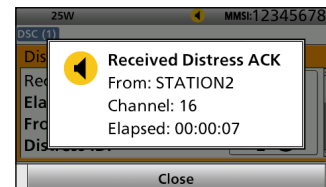

- ⑥ When the acknowledgment is received:
• An alarm sounds.
• The following screen is displayed.





- ⑦ Push any [Close] .
- When the BAM function (p. 20) is OFF: Push any [Alarm OFF] , and then push any [Close Call RCVD Window] .
- ⑧ Hold down [PTT] to announce your situation.
- ⑨ Push [Home]  to return to the Main screen.

◇ Sending a Distress Cancel call

While waiting for an acknowledgment, you can send a Distress Cancel call.

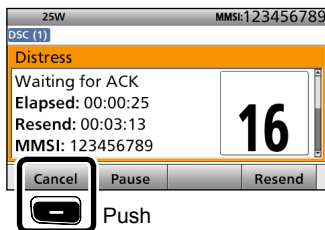
- ① When "Waiting for ACK" is displayed, push [Cancel] .



- ② Push [OK]  to send a Distress Cancel call.

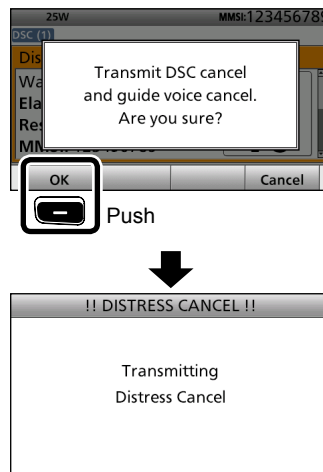

- ③ After sending, the following screen is displayed.

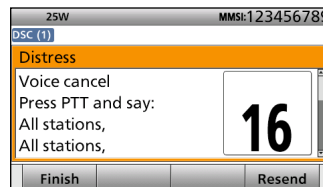

- ④ Hold down [PTT] to announce your cancel statement.
 - Rotate [CH/ENT] to view the cancel statement of the Distress Cancel call.
- ⑤ Select your desired action.
[Finish]: Finishes the Distress Cancel procedures.
[Resend]: Sends a Distress Cancel call again.
- ⑥ Push [Home]  to return to the Main screen.

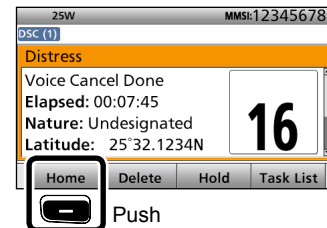

8 DSC OPERATION

■ Sending a Distress call (Continued)

◇ Sending a Distress acknowledgment



Distress call reception should stop after one sequence because the coast station should send back an 'acknowledgment' to the ship.

If the Distress call continues even after the coast station sends back an 'acknowledgment,' the ship in distress may not be receiving the acknowledgment.

In such cases, you should send back an 'acknowledgment' instead of the coast station and contact the coast station.

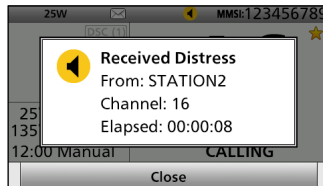
- ① When a Distress call is received:
 - An alarm sounds.
 - The following screen is displayed.



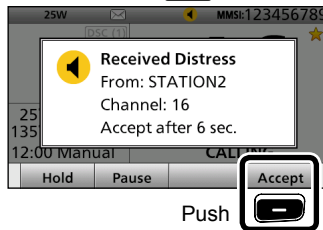

- ② Push any [Close] .
 - When the BAM function (p. 20) is OFF: Push any [Alarm OFF] .
- ③ Push [Accept] .

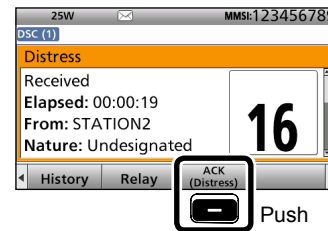

- Enters the DSC Task mode.
- ④ Push [▶] to scroll the Software Key functions.

- ⑤ Push [ACK (Distress)] .



- ⑥ Push [OK] .

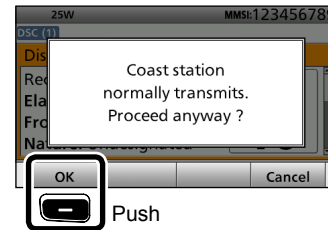



- The call contents screen is displayed.
- Rotate [CH/ENT] to view the call contents.

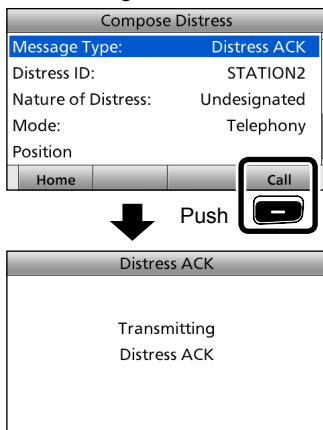

- ⑦ Push [Call]  to send a Distress acknowledgment.

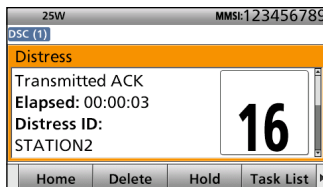



- ⑧ After sending, the following screen is displayed.

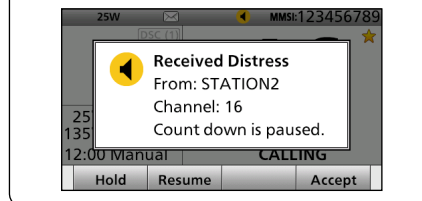

- ⑨ Hold down [PTT] to communicate with the ship in distress.
 ⑩ Push [Home]  to return to the Main screen.

TIP: When you push [Pause]  in step ③, the countdown will be paused. Push [Resume]  to restart the countdown.



TIP: When a Distress call related to MOB (Man Overboard) is received: Push [Devices List]  in step ⑤ to display the Devices List screen, and then push [ACK] .

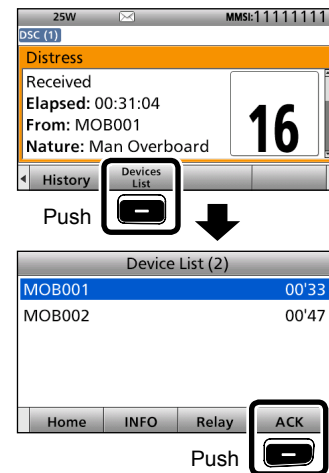

8 DSC OPERATION

■ Sending a Distress call (Continued)

◇ Sending a Distress Relay call

There are two ways to transmit the Distress Relay call—"Distress Relay On Behalf Of Someone Else (DROBOSE)" and "Distress Relay Call with Distress Call Log."

NOTE: DO NOT push [DISTRESS] to transmit a Distress Relay call. You should use it for only your own ship's Distress call.

To transmit the Distress Relay call with "DROBOSE":

You may transmit a Distress Relay call when a ship in distress cannot successfully send a Distress call, or when you find a ship in distress and it requires your immediate help.

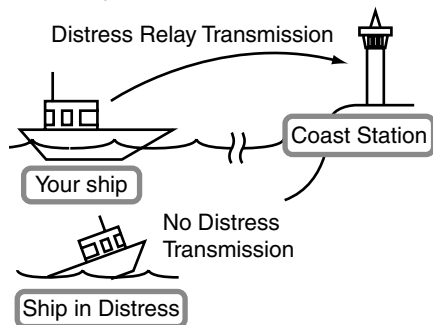

- ① Push [Compose DROBOSE]  to display the Compose DROBOSE screen.

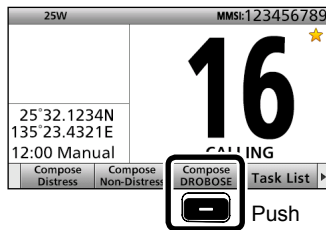

• To display the screen from the Menu screen: ([MENU] > **Compose DROBOSE**)

- ② Select "Message Type," then push [ENT].
- ③ Select the desired message type, then push [ENT]. (Example: Individual)

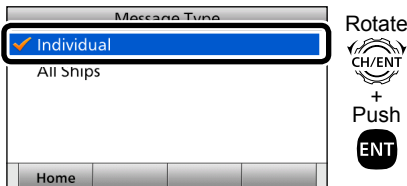

When you select "All Ships" in step ③, "Address" is not displayed in step ④. In that case, go to step ⑥.

- ④ Select "Address," then push [ENT].
- ⑤ Select the desired coast station address or "Manual Input," then push [ENT]. (Example: STATION1)

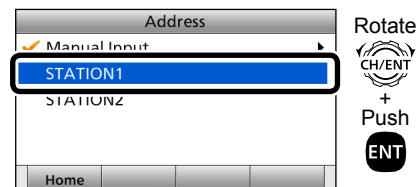

When you select "Manual Input" in step ⑤, push the keypad to manually enter the desired Individual ID. (p. 29)



- ⑥ Select "Distress ID," then push [ENT].

- ⑦ Select “Manual Input,” then push [ENT].

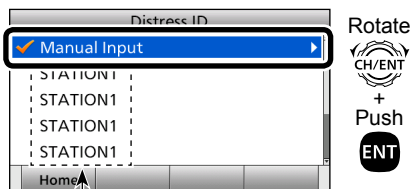

The Distress Call Log is displayed after receiving the Distress call. **DO NOT** select an ID for DROBOSE.

- ⑧ Enter the 9 digit Distress ID (MMSI ID) code of the ship in distress that you wish to help.

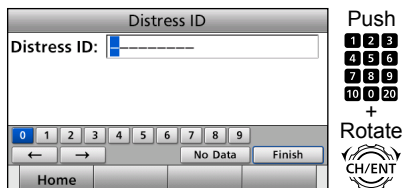

If you do not know the Distress ID, you can skip step ⑧, and go to step ⑩.

- ⑨ After entering, select “Finish,” and then push [ENT].
 ⑩ Select “Nature of Distress,” then push [ENT].
 ⑪ Select the desired option, then push [ENT].
 (Example: Fire, Explosion)

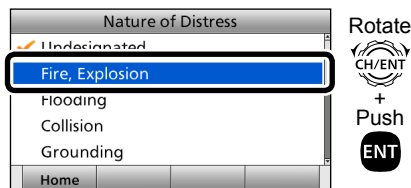

Options:

Undesignated, Fire, Explosion, Flooding, Collision, Grounding, Capsizing, Sinking, Adrift, Abandoning Ship, Piracy, Man Overboard, and EPIRB Emission.
 • The transceiver holds this setting for 30 seconds.

- ⑫ Select “Position,” then push [ENT].

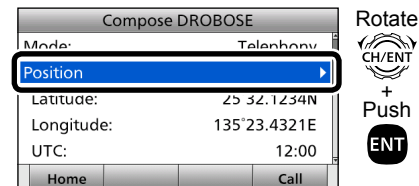

- The position entry screen is displayed.
- Your position and time are displayed.

- ⑬ Enter the position and time data of the ship in distress.
 • See page 31 for entering details.
 ⑭ After entering, select “Finish,” and then push [ENT].

8 DSC OPERATION

- Sending a Distress call (Continued)
- ◇ Sending a Distress Relay call (Continued)

15 Push [Call]  to send the Distress Relay call.

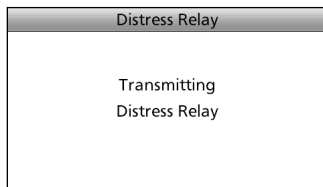
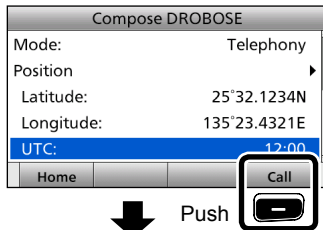

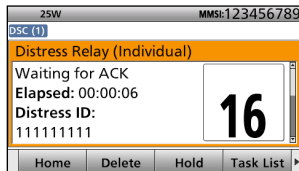

16 After sending, the following screen is displayed.

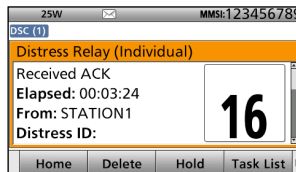

- 17 When the acknowledgment is received:
- An alarm sounds.
 - The following screen is displayed.



- When the BAM function (p. 20) is OFF: The backlight blinks and the popup screen is displayed. Push any [Alarm OFF] , and then push any [Close Call RCVD Window] .

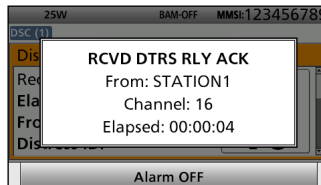



When the BAM function is OFF.

- 18 Hold down [PTT] to communicate.
- 19 Push [Home]  to return to the Main screen.

To transmit the distress relay call with “Distress Call Log”:

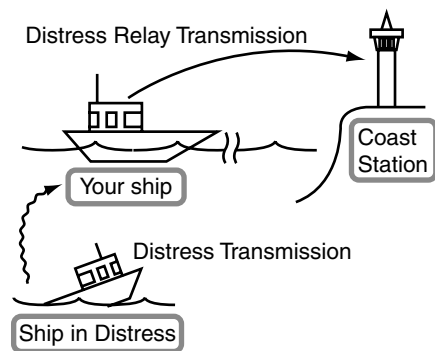
You can relay a Distress call after receiving it.



- ① Push [Compose DROBOSE]  to display the Compose DROBOSE screen.
 - To display the screen from the Menu screen: ([MENU] > **Compose DROBOSE**)
- ② Select “Message Type,” then push [ENT].

- ③ Select the desired message type. (Example: Individual)

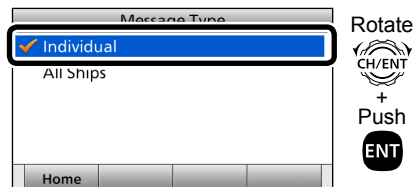

When you select “All Ships” in step ③, “Address” is not displayed in step ④. In that case, go to step ⑥.

- ④ Select “Address,” then push [ENT].
- ⑤ Select the desired coast station address or “Manual Input,” then push [ENT]. (Example: STATION1)

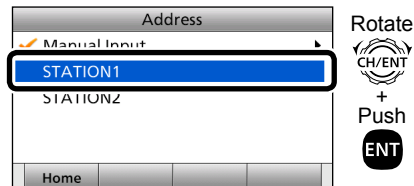

When you select “Manual Input” in step ⑤, push the keypad to manually enter the desired Individual ID. (p. 29)

The screenshot shows the 'Individual ID' input screen with a numeric keypad (0-9) and 'Finish' and 'Home' buttons.

- ⑥ Select “Distress ID,” then push [ENT].
- ⑦ Select the required Distress ID from the Call log list, then push [ENT].

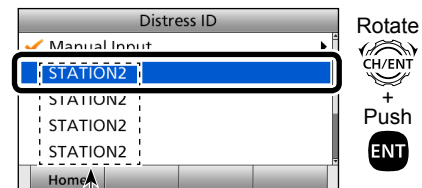



Distress Call Log is displayed after receiving the Distress Call.

8 DSC OPERATION

- Sending a Distress call (Continued)
- ◇ Sending a Distress Relay call (Continued)

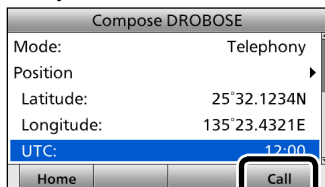
⑧ Push [Call]  to send the Distress Relay call.



↓ Push 



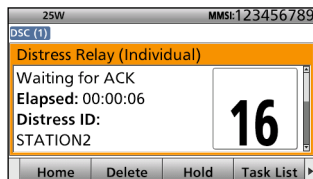

⑨ After sending, the following screen is displayed.

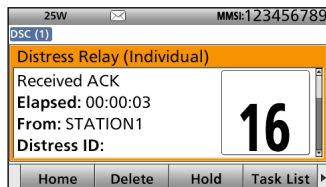

⑩ When the acknowledgment is received:

- An alarm sounds.
- The following screen is displayed.



- When the BAM function (p. 20) is OFF: The backlight blinks and the popup screen is displayed. Push any [Alarm OFF] , and then push any [Close Call RCVD Window] .

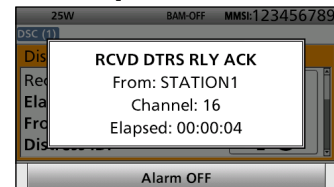

When the BAM function is OFF.



- Automatically selects Channel 16, and then you should monitor it, because a coast station may require assistance.
 - [PTT] is activated for voice communication via Channel 16.
 - Rotate [CH/ENT] to view the call contents.
- ⑪ Push [Home]  to return to the Main screen.

◇ Sending a Distress Relay acknowledgment

You can send the Distress Relay acknowledgment only when the Distress Relay call is received.

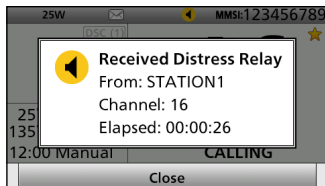
- ① When a Distress Relay call is received:
 - An alarm sounds.
 - The following screen is displayed.



- ② Push any [Close] .
 - When the BAM function (p. 20) is OFF: Push any [Alarm OFF] .
- ③ Push [Accept] .
 - Enters the DSC Task mode.
- ④ Push [▶] to scroll the Software Key functions.

- ⑤ Push [ACK (Relay)] .

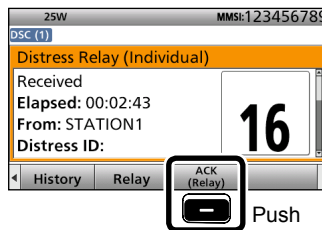

Push

- The call contents screen is displayed.
- Rotate [CH/ENT] to view the call contents.

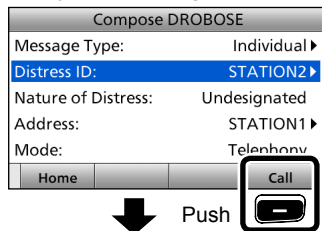

- ⑥ Push [Call]  to send the Distress Relay acknowledgment.



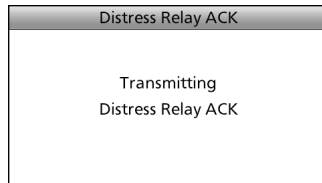

Push



- ⑦ Hold down [PTT] to communicate.
- ⑧ Push [Home]  to return to the Main screen.

TIP: When you push [Pause]  in step ③, the countdown will be paused. Push [Resume]  to restart the countdown.

TIP:
When a Distress Relay call related to MOB (Man Overboard) is received:
 Push [Devices List]  in step ⑤ to display the Devices List screen, and then push [ACK] .

■ Sending a Non-Distress call

To ensure correct operation of the DSC function, confirm you correctly set the Channel 70 squelch level. (p. 81)

NOTE:

- Emergency channel (Channel 70) is automatically selected for calling.
- If Channel 70 is busy, the transceiver stands by until the channel becomes clear.

◇ Sending an Individual call

The Individual call function enables you to transmit a DSC signal to only a specific coast station or ship. After transmission, wait for an acknowledgment from the receiving station.

You can communicate by voice after receiving the acknowledgment 'ACK (Able).'

- ① Push [Compose Non-Distress]  to display the Compose Non-Distress screen.

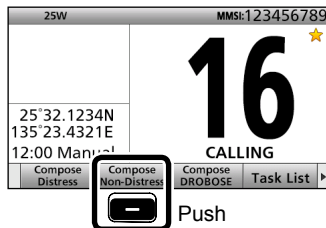

- To display the screen from the Menu screen:
([MENU] > **Compose Non-Distress**)

- ② Push [ENT].

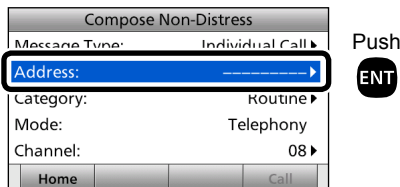

- ③ Select the desired individual address, or "Manual Input," then push [ENT].
(Example: STATION1)

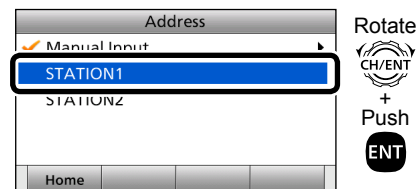

When you select "Manual Input" in step ③, push the keypad to manually enter the desired Individual ID. (p. 29)

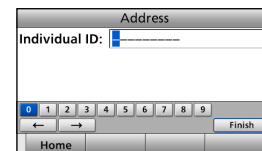

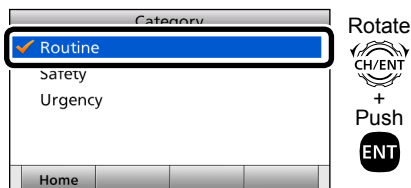

- ④ Select “Category,” then push [ENT].
 - ⑤ Select the desired option, then push [ENT].
- (Example: Routine)

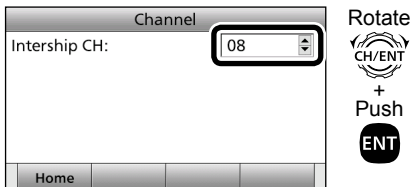

When you select a coast station in step ③, the voice channel is automatically specified by the coast station. Therefore, skip steps ⑥ and ⑦, and go to step ⑧.

- ⑥ Select “Channel,” then push [ENT].
- ⑦ Select the desired voice channel, then push [ENT].



- ⑧ Push [Call]  to send the Individual call.

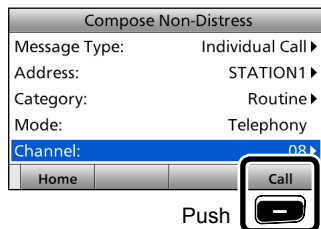

- ⑨ After sending, the following screen is displayed.

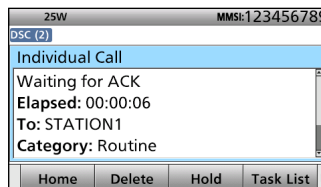

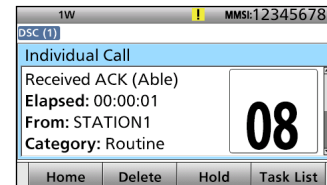

- ⑩ When the acknowledgment is received:
 - An alarm sounds.
 - The following screen is displayed.
 (Example: ACK (Able))



8 DSC OPERATION

■ Sending a Non-Distress calls (Continued)

◇ Sending an Individual call (Continued)

- When the BAM function (p. 20) is OFF: The backlight blinks and the popup screen is displayed. Push any [Alarm OFF] , and then push any [Close Call RCVD Window] .

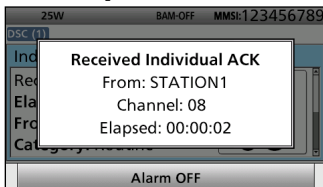

When the BAM function is OFF.

When you receive “ACK (Unable)” in step ⑩, skip step ⑪, and go to step ⑫.

- ⑪ Hold down [PTT] to communicate.
- ⑫ Push [Home]  to return to the Main screen.

NOTE:

After receiving the acknowledgment:



- The voice channel specified in step ⑦ is selected.
- A different voice channel is selected if the station you called cannot use the channel.

◇ Sending an Individual acknowledgment

When receiving an Individual call, you can send an acknowledgment ('Able,' 'Unable,' or 'New CH') by using the on-screen prompts.

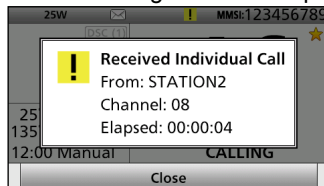
- ① When an Individual call is received:
 - An alarm sounds.
 - The following screen is displayed.



- ② Push any [Close] .
 - When the BAM function (p. 20) is OFF: Push any [Alarm OFF] .
- ③ Push [Accept] .

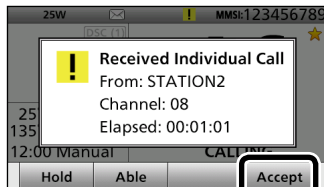

Push 

- Enters the DSC Task mode.

- ④ Push [▶] to scroll the Software Key functions.
- ⑤ Select your desired action.

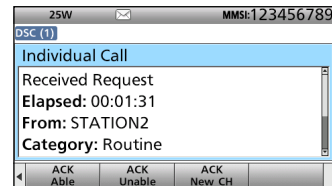

[ACK Able]:

Sends an acknowledgment without any changes.

[ACK Unable]:

Sends an acknowledgment, but you cannot make a communication.

[ACK New CH]:

Sends an acknowledgment. You can specify the Voice Communication channel.

- ⑥ Push [Call]  to send the Individual acknowledgment.

When you push [ACK Unable] in step ⑤, skip step ⑦, and go to step ⑧.

- ⑦ Hold down [PTT] to communicate.
- ⑧ Push [Home]  to return to the Main screen.

◇ Sending an All Ships call

All ships, that have DSC transceiver, use Channel 70 as their 'listening channel.' When you want to announce a message to these ships within range, use the 'All Ships Call' function.

- 1 Push [Compose Non-Distress]  to display the Compose Non-Distress screen.

- To display the screen from the Menu screen:
([MENU] > **Compose Non-Distress**)

- 2 Select "Message Type," then push [ENT].
- 3 Select "All Ships Call," then push [ENT].

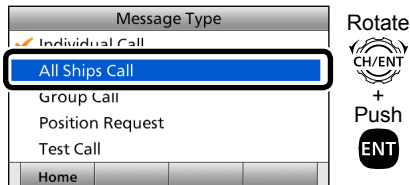

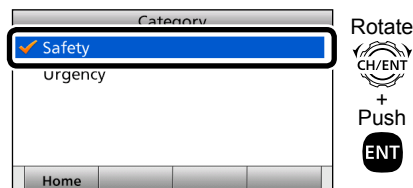

- 4 Select "Category," then push [ENT].

- 5 Select the desired option, then push [ENT].
(Example: Safety)

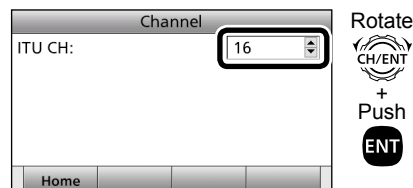

- 6 Select "Channel," then push [ENT].
- 7 Select the desired voice channel, then push [ENT].



- 8 Push [Call]  to send the All ships call.

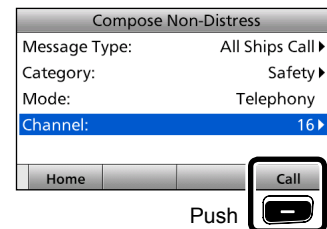

- 9 After sending, the following screen is displayed.

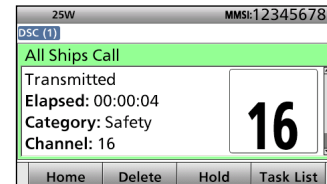

- 10 Hold down [PTT] to announce the message.
- 11 Push [Home]  to return to the Main screen.

8 DSC OPERATION

■ Sending a Non-Distress calls (Continued)

◇ Sending a Group call

The Group call function allows you to transmit a DSC signal to only a specific group.

- 1 Push [Compose Non-Distress]  to display the Compose Non-Distress screen.

• To display the screen from the Menu screen:
([MENU] > **Compose Non-Distress**)

- 2 Select "Message Type," then push [ENT].
- 3 Select "Group Call," then push [ENT].

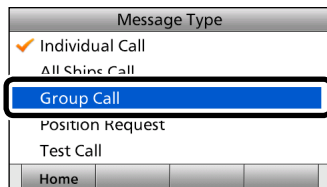

Rotate
CH/ENT
+
Push
ENT

- 4 Select "Address," then push [ENT].
- 5 Select the desired Group address or "Manual Input," then push [ENT].
(Example: GROUP1)

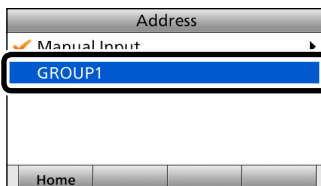

Rotate
CH/ENT
+
Push
ENT

When you select "Manual Input" in step ⑤, push the keypad to manually enter the desired Group ID. (p. 30)

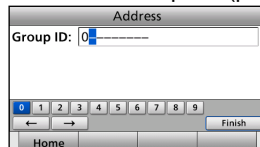

- 6 Select "Channel," then push [ENT].
- 7 Select the desired voice channel, then push [ENT].

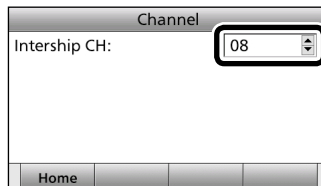

Rotate
CH/ENT
+
Push
ENT

- 8 Push [Call]  to send the Group call.

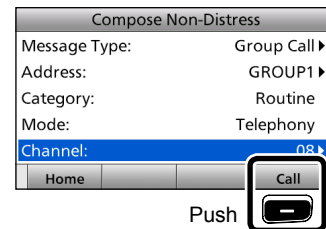

Push

- 9 After sending, the following screen is displayed.

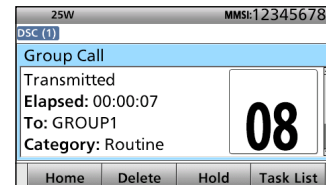

- 10 Hold down [PTT] to announce the message.
- 11 Push [Home]  to return to the Main screen.

◇ Sending a Position Request call

Transmit a Position Request call when you want to know a specific ship's current position, and so on.

- ① Push [Compose Non-Distress]  to display the Compose Non-Distress screen.
 - To display the screen from the Menu screen: ([MENU] > **Compose Non-Distress**)
- ② Select "Message Type," then push [ENT].
- ③ Select "Position Request," then push [ENT].

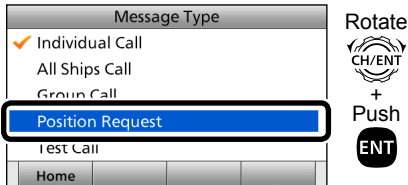

- ④ Select "Address," then push [ENT].
- ⑤ Select the desired individual address, or "Manual Input," then push [ENT].
(Example: STATION1)

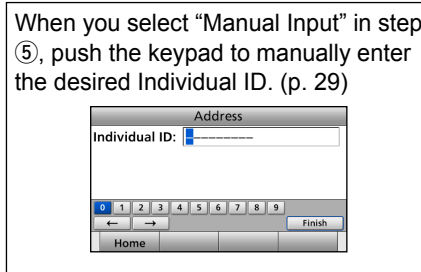
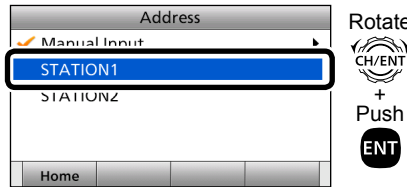

- ⑥ Push [Call]  to send the Position Request call.

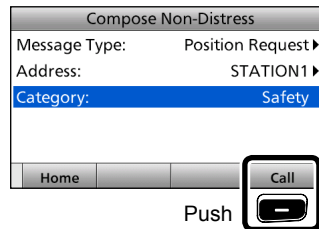

- ⑦ After sending, the following screen is displayed.

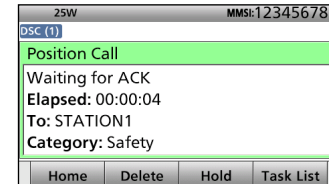

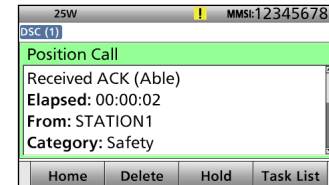

- ⑧ When the acknowledgment is received:
 - An alarm sounds.
 - The following screen is displayed.



8 DSC OPERATION

■ Sending a Non-Distress calls (Continued)

◇ Sending a Position Request call (Continued)

- When the BAM function (p. 20) is OFF: The backlight blinks and the popup screen is displayed. Push any [Alarm OFF] , and then push any [Close Call RCVD Window] .

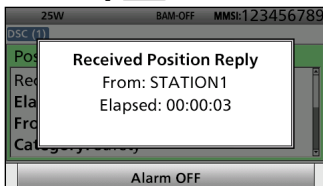

When the BAM function is OFF.

- Rotate [CH/ENT] to view the call contents (position data is included).
- ⑨ Push [Home]  to return to the Main screen.



◇ Sending a Position Request acknowledgment

When a Position Request call is received, you can send an acknowledgment.

① When a Position Request call is received:

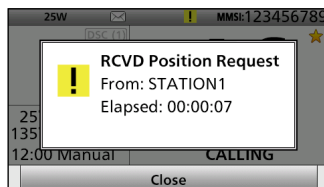
- An alarm sounds.
- The following screen is displayed.



- ② Push any [Close] .
 - When the BAM function (p. 20) is OFF: Push any [Alarm OFF] .
- ③ Push [Accept] .
 - Enters the DSC Task mode.
- ④ Push [▶] to scroll the Software Key functions.
- ⑤ Select your desired action.

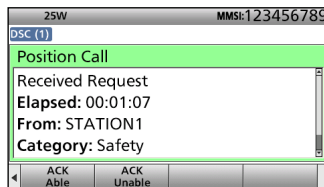



[ACK Able]:

Sends an acknowledgment with position and time data.

[ACK Unable]:

Sends an acknowledgment with no position and time data.

- The call contents screen is displayed.
 - Rotate [CH/ENT] to view the call contents.
 - Change your position data, if the displayed data is invalid. (p. 31)
- ⑥ Push [Call]  to send the acknowledgment.
 - When [ACK Able] is selected in step ⑤, your position and time data are transmitted.
 - ⑦ Push [Home]  to return to the Main screen.



TIP: When "Position ACK" is set to "Auto (Able)," the transceiver automatically sends the acknowledgment. (p. 77)

◇ Sending a Polling Request acknowledgment

When a Polling Request call is received, you can send an acknowledgment. A Polling Request call enables the calling station to know a specific ship is within communication range, or not.

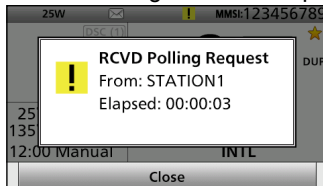

- ① When a Polling Request is received:
 - An alarm sounds.
 - The following screen is displayed.

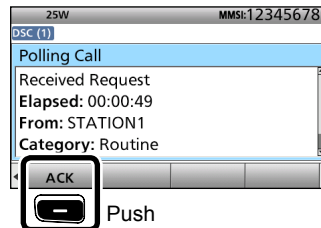

- ② Push any [Close] .
 - When the BAM function (p. 20) is OFF: Push any [Alarm OFF] .
- ③ Push [Accept] .
 - Enters the DSC Task mode.
- ④ Push [▶] to scroll the Software Key functions.

- ⑤ Push [ACK] .



- The call contents screen is displayed.
 - Rotate [CH/ENT] to view the call contents.
- ⑥ Push [Call]  to send the acknowledgment.
 - ⑦ Push [Home]  to return to the Main screen.

TIP: When “Polling ACK” is set to “Auto,” the transceiver automatically sends the acknowledgment. (p. 77)

8 DSC OPERATION

■ Sending a Non-Distress calls (Continued)

◇ Sending a Test call

Testing on the exclusive DSC distress and safety calling channels should be avoided as much as possible by using other methods.

Normally the test call would require no further communications between the two stations involved.

- 1 Push [Compose Non-Distress]  to display the Compose Non-Distress screen.

- To display the screen from the Menu screen:
([MENU] > **Compose Non-Distress**)

- 2 Select "Message Type," then push [ENT].
- 3 Select "Test Call."

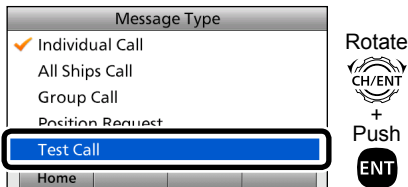

- 4 Select "Address," then push [ENT].

- 5 Select the desired Individual address, or "Manual Input." (Example: STATION1)

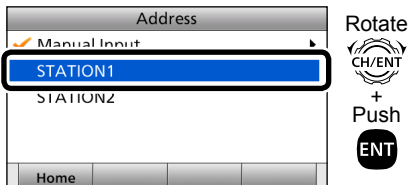

When you select "Manual Input" in step 5, push the keypad to manually enter the desired Individual ID. (p. 29)

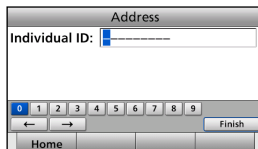

- 6 Push [Call]  to send the Test call.

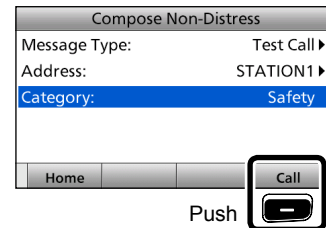

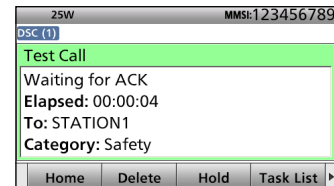

- 7 After sending, the following screen is displayed.

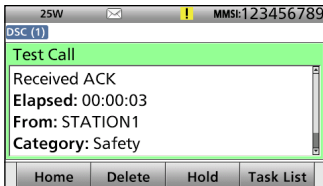

- 8 When the acknowledgment is received:
 - An alarm sounds.
 - The following screen is displayed.



- When the BAM function (p. 20) is OFF: The backlight blinks and the popup screen is displayed. Push any [Alarm OFF] , and then push any [Close Call RCVD Window] .

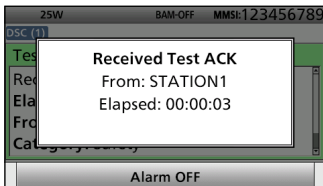



When the BAM function is OFF.

- ⑨ Rotate [CH/ENT] to view the received message log.
- ⑩ Push [Home]  to return to the Main screen.

◇ **Sending a Test call acknowledgment**

When a Test call is received, you can send an acknowledgment.

- ① When a Test call is received:
 - An alarm sounds.
- ② Push any [Close] .
 - When the BAM function (p. 20) is OFF: Push any [Alarm OFF] .
- ③ Push [Accept] .

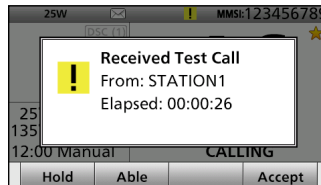

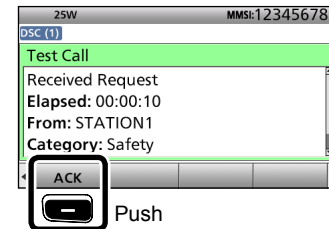

- Enters the DSC Task mode.
- ④ Push [▶] to scroll the Software Key functions.

- ⑤ Push [ACK] .



- The call contents screen is displayed.
- Rotate [CH/ENT] to view the call contents.

- ⑥ Push [Call]  to send the acknowledgment.
- ⑦ Push [Home]  to return to the Main screen.

TIP: When “Test ACK” is set to “Auto,” the transceiver automatically sends the acknowledgment. (p. 77)

8 DSC OPERATION

■ Sending a Non-Distress calls (Continued)

◇ Sending a Medical Transports call

The Medical Transports call informs all ships, by urgency priority, that your ship is carrying a patient in need of medical treatment.

NOTE: You should set the “Medical Transports” item to ON in advance. (p. 78)

- 1 Push [Compose Non-Distress]  to display the Compose Non-Distress screen.
 - To display the screen from the Menu screen:
([MENU] > **Compose Non-Distress**)
- 2 Select “Message Type,” then push [ENT].
- 3 Select “Medical Transports,” then push [ENT].

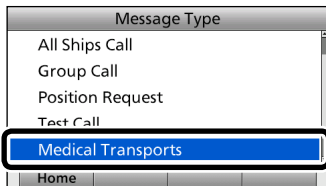

- 4 Select “Channel,” then push [ENT].
- 5 Select the desired traffic channel, then push [ENT].

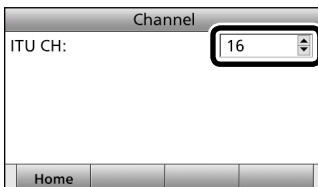

- 6 Push [Call]  to send the Medical Transports call.

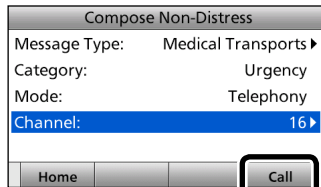

- 7 After sending, the following screen is displayed.

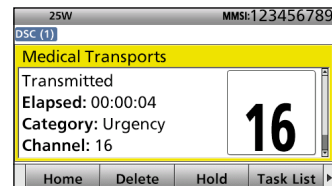

- Rotate [CH/ENT] to view the call contents.
- 8 Push [Home] to return to the Main screen.

◇ Sending a Ships and Aircraft call

The Ships and Aircraft call informs all ships that your ship is a neutral (not a participant) in armed conflict. Be sure to send the call **BEFORE** entering an area of armed conflict.

NOTE: You should set the “Ships and Aircraft” item to ON in advance. (p. 78)

- ① Push [Compose Non-Distress]  to display the Compose Non-Distress screen.
 - To display the screen from the Menu screen: ([MENU] > **Compose Non-Distress**)
- ② Select “Message Type,” then push [ENT].
- ③ Select “Ships and Aircraft,” then push [ENT].

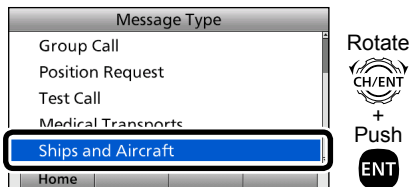

- ④ Select “Channel,” then push [ENT].
- ⑤ Select the desired traffic channel, then push [ENT].

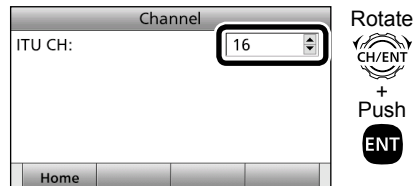

- ⑥ Push [Call]  to send the Ships and Aircraft call.

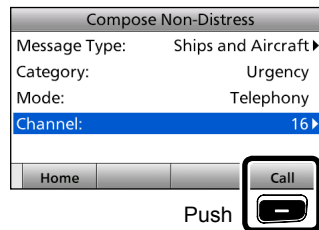

- ⑦ After sending, the following screen is displayed.

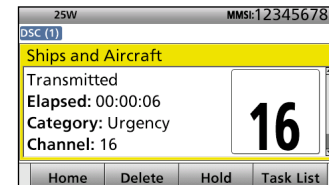

- Rotate [CH/ENT] to view the call contents.
- ⑧ Push [Home]  to return to the Main screen.

■ Receiving DSC calls

NOTE:

After receiving a DSC call:

- “DSC (1)” is continuously displayed when the transceiver has DSC tasks. (p. 6)
- “✉” is displayed when there are unread DSC messages. (p. 75)
- “✉” blinks when a DSC message is received.

When receiving a Distress Cancel call or an acknowledgment:

- The popup screen may be displayed, even when the BAM function is ON, if you deleted the task before receiving a Distress Cancel call or an acknowledgment.
- The displayed contents may differ, depending on the operating screen.



◇ Receiving a Distress Call

IMPORTANT!

Distress call reception should stop after one sequence because the coast station should send back an ‘acknowledgment’ to the ship. If the distress call continues, even after the coast station sends back an ‘acknowledgment,’ the ship in distress may not receive the acknowledgment. In such cases, you should send back an ‘acknowledgment’ instead of the coast station and contact the coast station. (p. 40)

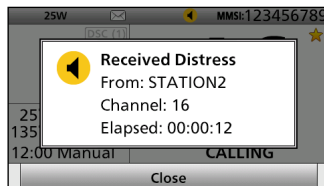
- ① When a Distress call is received:
 - An alarm sounds.
 - The following screen is displayed.
 - The backlight blinks when the BAM function (p. 20) is OFF.



- ② Push any [Close] .
 - When the BAM function (p. 20) is OFF: Push any [Alarm OFF] .
- ③ Select your desired action.

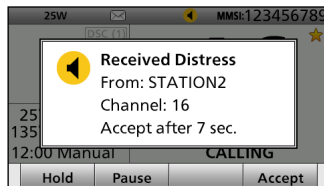

[Hold]: Holds the RX call task, and return to the previous screen.

[Pause]: Pauses the countdown.
 • To restart the countdown, push [Resume] .

[Accept]: Enters the DSC Task mode. To send the acknowledgment, push [Accept] .

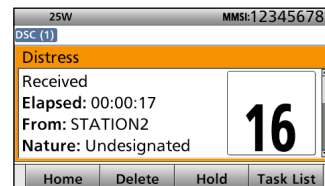

DSC Task mode

- Automatically selects Channel 16, and then you should monitor it, because a coast station may require assistance.
- Rotate [CH/ENT] to view the call contents.

When you select [Accept] in step ③, you can send the Relay call in the DSC Task mode. To send the Relay call, go to step ④. If you return to the Main screen without sending the Relay call, go to step ⑩.

- ④ Push [▶] to scroll the Software Key functions.

⑤ Push [Relay].

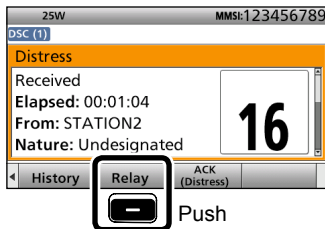

⑥ When the confirmation screen is displayed, push [OK].

⑦ Select "Address," then push [ENT].

⑧ Select the desired individual address, or "Manual Input," then push [ENT].

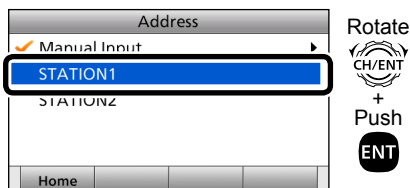

⑨ Push [Call] to send the Relay call.

⑩ Push [Home] to return to the Main screen.

TIP: See page 40 for details of sending an acknowledgment.

TIP:

When a Distress call related to MOB (Man Overboard) is received: Push [Devices List] in step ⑤ to display the Devices List screen, and then push [Relay].



Push



Push

◇ **Receiving a Distress acknowledgment**

① When a Distress acknowledgment sent to another ship is received:

- An alarm sounds.
- The following screen is displayed.
- The backlight blinks when the BAM function (p. 20) is OFF.

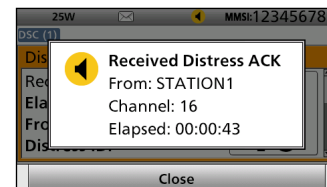

② Push any [Close].

- When the BAM function (p. 20) is OFF: Push any [Alarm OFF], and then push any [Close Call RCVD Window].

8 DSC OPERATION

■ Receiving DSC calls (Continued)

◇ Receiving a Distress acknowledgment

- Enters the DSC Task mode.

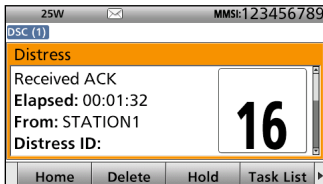



DSC Task mode

- Automatically selects Channel 16, and then monitor it, because a coast station may require assistance.
 - Rotate [CH/ENT] to view the call contents.
- ③ Push [Home]  to return to the Main screen.

◇ Receiving a Distress Cancel call

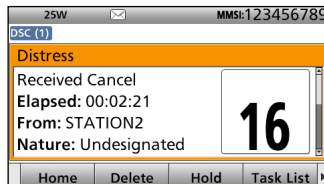
- ① When a Distress Cancel call is received:
- An alarm sounds.
 - The following screen is displayed.



- When the BAM function (p. 20) is OFF: The backlight blinks and the popup screen is displayed. Push any [Alarm OFF] , and then push any [Close Call RCVD Window] .

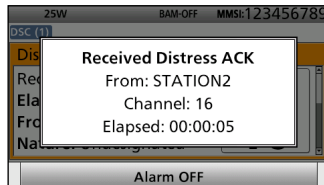



When the BAM function is OFF.

- Automatically selects Channel 16, and then you should monitor it, because a coast station may require assistance.
 - Rotate [CH/ENT] to view the call contents.
- ② Push [Home]  to return to the Main screen.

◇ Receiving a Distress Relay call

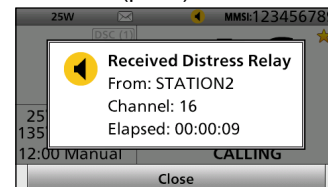
- ① When a Distress Relay call is received:
- An alarm sounds.
 - The following screen is displayed.
 - The backlight blinks when the BAM function (p. 20) is OFF.



- ② Push any [Close] .
- When the BAM function (p. 20) is OFF: Push any [Alarm OFF] .
- ③ Select your desired action.

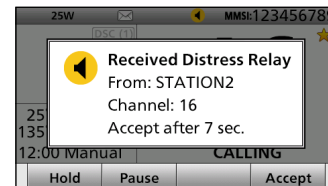

[Hold]: Holds the RX call task, and return to the previous screen.

[Pause]: Pauses the countdown.
• To restart the countdown, push [Resume] .

[Accept]: Enters the DSC Task mode.
To send the acknowledgment, push [Accept] .

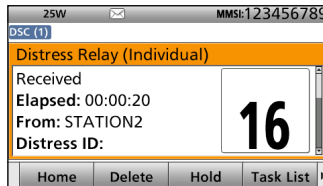

DSC Task mode



- Automatically selects Channel 16, and then monitor it, because a coast station may require assistance.
 - Rotate [CH/ENT] to view the call contents.
- ④ Push [Home]  to return to the Main screen.

TIP: See page 47 for details of sending acknowledgment.

◇ **Receiving a Distress Relay acknowledgment**

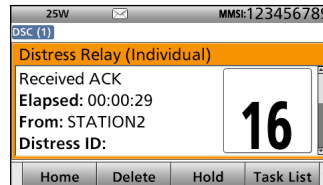
- ① When a Distress Relay acknowledgment is received:
- An alarm sounds.
 - The following screen is displayed.



- When the BAM function (p. 20) is OFF: The backlight blinks and the popup screen is displayed. Push any [Alarm OFF] , and then push any [Close Call RCVD Window] .

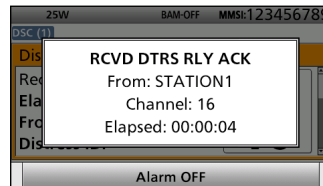

When the BAM function is OFF.

- Automatically selects Channel 16, and then you should monitor it, because a coast station may require assistance.
 - [PTT] is activated for voice communication via Channel 16.
 - Rotate [CH/ENT] to view the call contents.
- ② Push [Home]  to return to the Main screen.

8 DSC OPERATION



■ Receiving DSC calls (Continued)

◇ Receiving an Individual call

NOTE: When the “Individual ACK” item is set to “Auto (Unable),” the transceiver automatically sends an acknowledgment. Both the TX and RX calls are stored in the Transmitted and Received Call Logs. (pp. 75, 76)

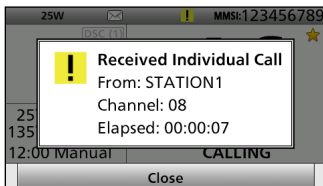
- ① When an Individual call is received:
 - An alarm sounds.
 - The following screen is displayed.
 - The backlight blinks when the BAM function (p. 20) is OFF.



- ② Push any [Close] .
- When the BAM function (p. 20) is OFF: Push any [Alarm Off] .
- ③ Select your desired action.

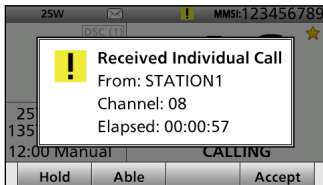

[Hold]: Holds the RX call task, and return to the previous screen.

[Able]: Sends an acknowledgment without any changes.

[Accept]: Enters the DSC Task mode. To send the acknowledgment, push [Accept] .

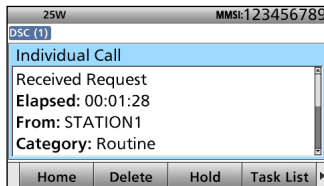



DSC Task mode

- Rotate [CH/ENT] to view the call contents.

When you select [Accept] in step ③, you can send an acknowledgment in the DSC Task mode. To send the acknowledgment, go to step ④. If you return to the Main screen without sending the acknowledgment, go to step ⑧.

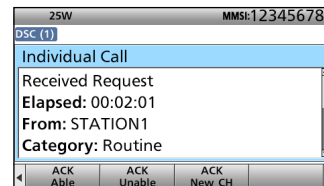
- ④ Push [▶] to scroll the Software Key functions.



- ⑤ Push the desired key to select an acknowledgment option.
- ⑥ Push [Call]  to send the Individual acknowledgment.
- ⑦ Depending on the option selected in step ⑤, hold down [PTT] to communicate.
- ⑧ Push [Home]  to return to the Main screen.

TIP: When you send the acknowledgment, select one of three options, depending on your situation. See page 50 for details of the Individual acknowledgment procedures.



◇ Receiving an Individual acknowledgment

When receiving “ACK Able”:

You can make voice communication on the channel that you specified when you sent the call.

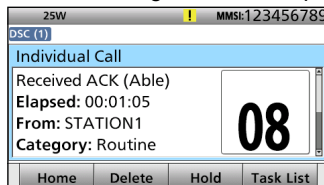
- ① When an Individual acknowledgment “ACK Able” is received:
 - An alarm sounds.
 - The following screen is displayed.



- When the BAM function (p. 20) is OFF: The backlight blinks and the popup screen is displayed. Push any [Alarm OFF] , and then push any [Close Call RCVD Window] .

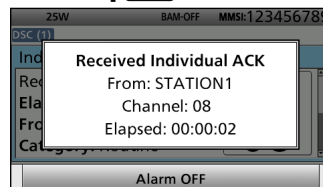

When the BAM function is OFF.

- Automatically selects the channel that you specified when you sent the call for voice communication.
 - Rotate [CH/ENT] to view the call contents.
- ② Hold down [PTT] to communicate.
 - ③ Push [Home]  to return to the Main screen.

8 DSC OPERATION

■ Receiving DSC calls (Continued)

◇ Receiving an Individual acknowledgment (Continued)



When receiving “ACK Unable”:

You cannot make the voice communication.

① When an Individual acknowledgment “ACK Unable” is received:

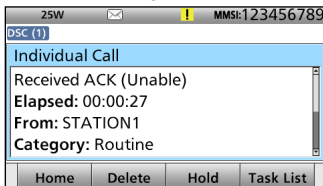
- An alarm sounds.
- The following screen is displayed.



- When the BAM function (p. 20) is OFF: The backlight blinks and the popup screen is displayed. Push any [Alarm OFF] , and then push any [Close Call RCVD Window] .

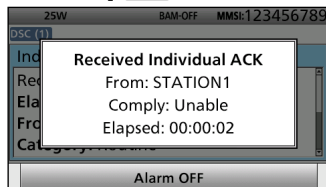

When the BAM function is OFF.

- Rotate [CH/ENT] to view the call contents.
- ② Push [Home]  to return to the Main screen.



When receiving “ACK New CH”:

You can make voice communication on the channel that is proposed by the called station.

① When an Individual acknowledgment “ACK New CH” is received:

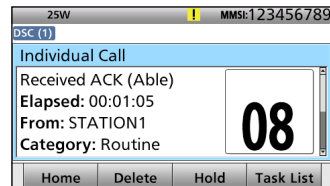
- An alarm sounds.
- The following screen is displayed.



- When the BAM function (p. 20) is OFF: The backlight blinks and the popup screen is displayed. Push any [Alarm OFF] , and then push any [Close Call RCVD Window] .

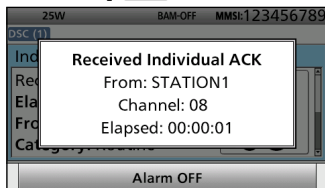



When the BAM function is OFF.

- Automatically selects the channel that is proposed by the called station for voice communication.
 - Rotate [CH/ENT] to view the call contents.
- ② Hold down [PTT] to communicate.
 - ③ Push [Home]  to return to the Main screen.

◇ Receiving an All Ships call

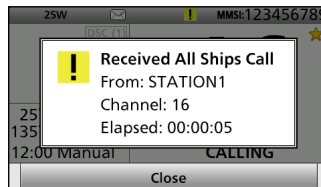

- ① When an All Ships call is received:
 - An alarm sounds.
 - The following screen is displayed.
 - The backlight blinks when the BAM function (p. 20) is OFF.

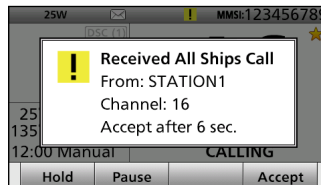

- ② Push any [Close] .
 - When the BAM function (p. 20) is OFF: Push any [Alarm OFF] .
- ③ Select your desired action.



[Hold]: Push [Hold]  to return to the Main screen.

- [Pause]: Push [Pause]  to pause the countdown.
- To restart the countdown, push [Resume] .
- [Accept]: Push [Accept]  to enter the DSC Task mode.

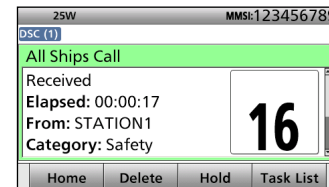

DSC Task mode

- Monitor the channel specified by the calling station for an announcement from the calling station. (Example: Channel 16)
 - Rotate [CH/ENT] to view the call contents.
- ④ Push [Home]  to return to the Main screen.



8 DSC OPERATION

■ Receiving DSC calls (Continued)

◇ Receiving a Group call

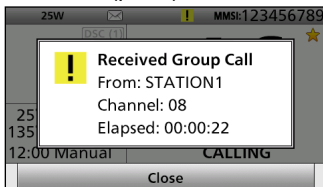
- ① When a Group call is received:
 - An alarm sounds.
 - The following screen is displayed.
 - The backlight blinks when the BAM function (p. 20) is OFF.



- ② Push any [Close] .
 - When the BAM function (p. 20) is OFF: Push any [Alarm OFF] .
- ③ Select your desired action.

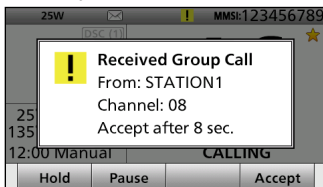

[Hold]: Holds the RX call task, and return to the previous screen.

[Pause]: Pauses the countdown.
 • To restart the countdown, push [Resume] .

[Accept]: Enters the DSC Task mode.





DSC Task mode

- Monitor the channel specified by the calling station for an announcement from the calling station. (Example: Channel 08)
 - Rotate [CH/ENT] to view the call contents.
- ④ Push [Home]  to return to the Main screen.

◇ Receiving a Geographical Area call

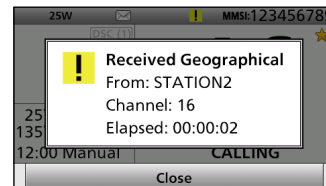
- ① When a Geographical Area call (for the area you are in) is received:
 - An alarm sounds.
 - The following screen is displayed.
 - The backlight blinks when the BAM function (p. 20) is OFF.



- ② Push any [Close] .
 - When the BAM function (p. 20) is OFF: Push any [Alarm OFF] .
- ③ Select your desired action.

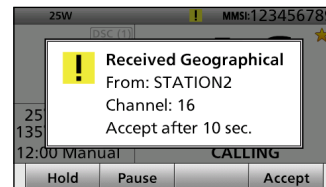

[Hold]: Holds the RX call task, and return to the previous screen.

- [Pause]: Pauses the countdown.
 - To restart the countdown, push [Resume] .
- [Accept]: Enters the DSC Task mode.

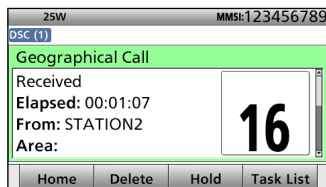

DSC Task mode



- Monitor the channel specified by the calling station for an announcement from the calling station. (Example: Channel 16)
- Rotate [CH/ENT] to view the call contents.
- ④ Push [Standby Mode]  to return to the Main screen.

◇ Receiving a Position Request Call

NOTE: When “Position ACK” is set to “Auto (Able),” the transceiver automatically replies to the call. Both the TX and RX calls are stored in the Transmitted and Received Call Logs. (Default: Manual)

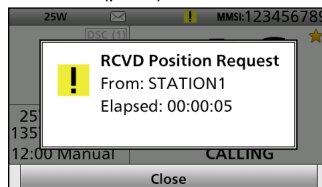
- ① When a Position Request call is received:
 - An alarm sounds.
 - The following screen is displayed.
 - The backlight blinks when the BAM function (p. 20) is OFF.



- ② Push any [Close] .
 - When the BAM function (p. 20) is OFF: Push any [Alarm OFF] .
- ③ Select your desired action.

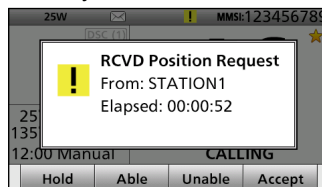

- [Hold]: Holds the RX call task, and return to the previous screen.
- [Able]: Sends an acknowledgment with position and time data.
- [Unable]: Sends an acknowledgment with no position and time data.
- [Accept]: Enters the DSC Task mode.

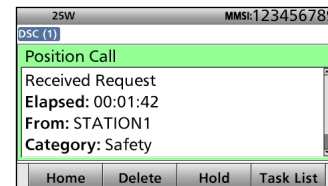

DSC Task mode

- Rotate [CH/ENT] to view the call contents.
- ④ Push [Home]  to return to the Main screen.

TIP: See page 54 for details of sending an acknowledgment.



8 DSC OPERATION

■ Receiving DSC calls (Continued)

◇ Receiving a Position Request acknowledgment

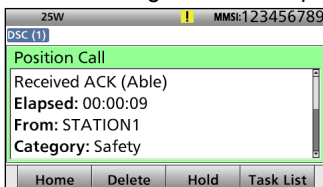
- ① When a Position Request acknowledgment is received:
 - An alarm sounds.
 - The following screen is displayed.



- When the BAM function (p. 20) is OFF: The backlight blinks and the popup screen is displayed. Push any [Alarm OFF] , and then push any [Close Call RCVD Window] .

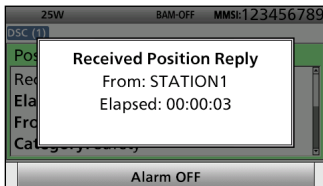

When the BAM function is OFF.



- Rotate [CH/ENT] to view the call contents.

- ② Push [Home]  to return to the Main screen.

◇ Receiving a Position Report call

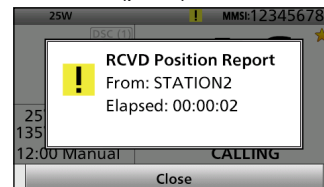
- ① When a Position Report call is received:
 - An alarm sounds.
 - The following screen is displayed.
 - The backlight blinks when the BAM function (p. 20) is OFF.



- ② Push any [Close] .
 - When the BAM function (p. 20) is OFF: Push any [Alarm OFF] .
- ③ Select your desired action.

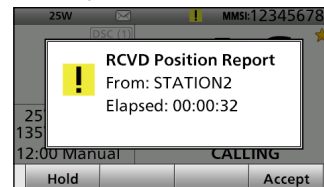

[Hold]:

Holds the RX call task, and return to the previous screen.

[Accept]:
Enters the DSC Task mode.

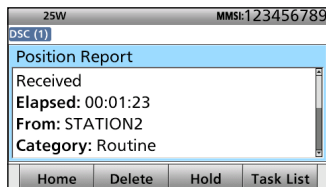

DSC Task mode



- Rotate [CH/ENT] to view the call contents, including the position data.
- ④ Push [Home]  to return to the Main screen.

◇ Receiving a Polling Request call

NOTE: When “Polling ACK” is set to “Auto,” the transceiver automatically replies to the call. Both the TX and RX calls are stored in the Transmitted and Received Call Logs. (Default: Auto)

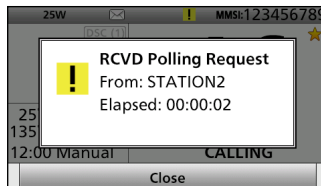
- ① When a Polling Request call is received:
 - An alarm sounds.
 - The following screen is displayed.
 - The backlight blinks when the BAM function (p. 20) is OFF.



- ② Push any [Close] .
 - When the BAM function (p. 20) is OFF: Push any [Alarm OFF] .
- ③ Select your desired action.

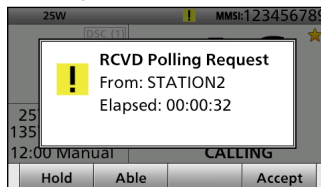

[Hold]: Holds the RX call task, and return to the previous screen.

[Able]: Sends an acknowledgment.

[Accept]: Enters the DSC Task mode.

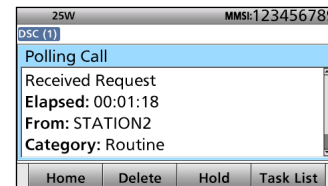

DSC Task mode

- Rotate [CH/ENT] to view the call contents.
- ④ Push [Home]  to return to the Main screen.

TIP: See page 55 for details of sending an acknowledgment.

8 DSC OPERATION



■ Receiving DSC calls (Continued)

◇ Receiving a Test call

NOTE: When "Test ACK" is set to "Auto," the transceiver automatically replies to the call. Both the TX and RX calls are stored in the Transmitted and Received Call Logs. (Default: Auto)

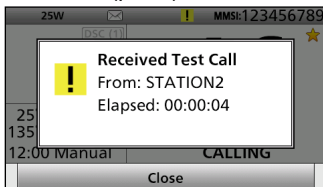
- ① When a Test call is received:
 - An alarm sounds.
 - The following screen is displayed.
 - The backlight blinks when the BAM function (p. 20) is OFF.



- ② Push any [Close] .
 - When the BAM function (p. 20) is OFF: Push any [Alarm OFF] .
- ③ Select your desired action.

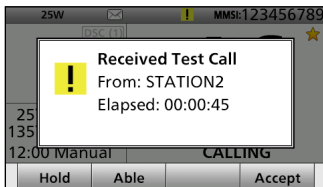

[Hold]: Holds the RX call task, and return to the previous screen.

[Able]: Sends an acknowledgment.

[Accept]: Enters the DSC Task mode.

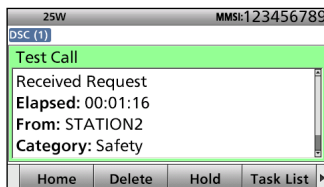

DSC Task mode



- Rotate [CH/ENT] to view the call contents.
- ④ Push [Home]  to return to the Main screen.

TIP: See page 57 for details of sending an acknowledgment.

◇ Receiving a Test acknowledgment

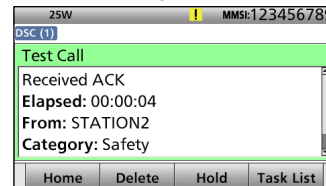
- ① When a Test acknowledgment is received:
 - An alarm sounds.
 - The following screen is displayed.



- When the BAM function (p. 20) is OFF: The backlight blinks and the popup screen is displayed. Push any [Alarm OFF] , and then push any [Close Call RCVD Window] .

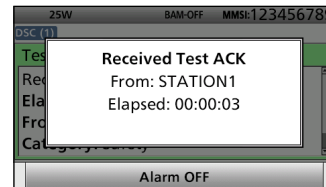



When the BAM function is OFF.

- Rotate [CH/ENT] to view the call contents.
- ② Push [Home]  to return to the Main screen.

◇ Receiving a Medical Transports call

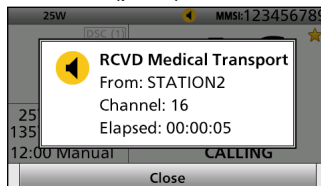
- ① When a Medical Transports call is received:
 - An alarm sounds.
 - The following screen is displayed.
 - The backlight blinks when the BAM function (p. 20) is OFF.



- ② Push any [Close] .
 - When the BAM function (p. 20) is OFF: Push any [Alarm OFF] .
- ③ Select your desired action.

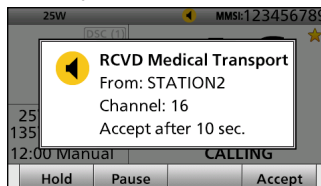

[Hold]: Holds the RX call task, and return to the previous screen.

- [Pause]: Pauses the countdown.
- To restart the countdown, push [Resume] .
- [Accept]: Enters the DSC Task mode.

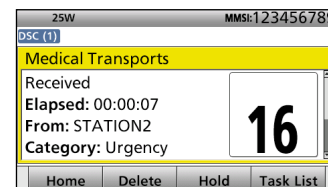

DSC Task mode

- Monitor the channel specified by the calling station for an announcement from the calling station. (Example: Channel 16)
- Rotate [CH/ENT] to view the call contents.
- ④ Push [Home]  to return to the Main screen.



8 DSC OPERATION

■ Receiving DSC calls (Continued)

◇ Receiving a Ships and Aircraft call

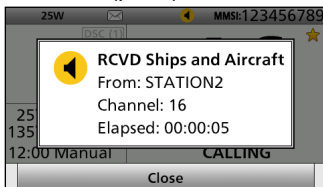
- ① When a Ships and Aircraft call is received:
 - An alarm sounds.
 - The following screen is displayed.
 - The backlight blinks when the BAM function (p. 20) is OFF.



- ② Push any [Close] .
 - When the BAM function (p. 20) is OFF: Push any [Alarm OFF] .
- ③ Select your desired action.

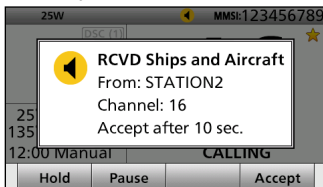

[Hold]: Holds the RX call task, and return to the previous screen.

- [Pause]: Pauses the countdown.
 - To restart the countdown, push [Resume] .
- [Accept]: Enters the DSC Task mode.

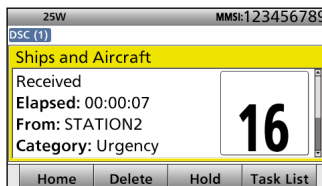

DSC Task mode

- Monitor the channel specified by the calling station for an announcement from the calling station. (Example: Channel 16)
 - Rotate [CH/ENT] to view the call contents.
- ④ Push [Home]  to return to the Main screen.

■ Received Call log

The transceiver automatically stores up to 50 distress messages and 50 other messages, and they can be used as a supplement to your logbook.

- When there are unread DSC messages, "✉" is displayed on the information area of the LCD.
- When a DSC message is received, "✉" blinks on the information area of the LCD.
- "✉" is displayed when there are unread DSC messages.
- "✉" is displayed when there are no unread DSC messages.
- No icon is displayed when there are no DSC messages.
- Distress messages are stored in "Distress."

Software Key functions in the Received Call Log screen:

- [Home]: Push to return to the Main screen.
 [Delete]: Push to delete the selected message.
 [INFO]: Push to display the detailed information.
 [MMSI]: Push to save the MMSI as an Individual ID.
 [Print]: Push to print out the selected message when a printer is connected to the transceiver.

◇ Distress message

- ① Push [DSC Log]  to display the Received Call Log screen.
 - To display the screen from the Menu screen:
 ([MENU] > DSC Log > **Received Call Log**)
- ② Select "Distress," then push [ENT].
- ③ Select the desired message, then push [ENT].

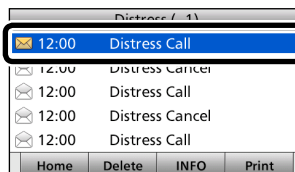

- ④ Rotate [CH/ENT] to view the contents.
 - To view another message, push [CLR] to return to the previous screen. And then, select the desired message.
- ⑤ Push [Home]  to return to the Main screen.

◇ Other messages

- ① Push [DSC Log]  to display the Received Call Log screen.
 - To display the screen from the Menu screen:
 ([MENU] > DSC Log > **Received Call Log**)
- ② Select "Others," then push [ENT].
- ③ Select the desired message, then push [ENT].

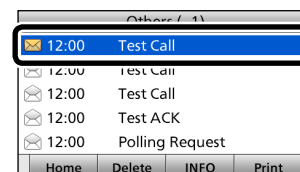

- ④ Rotate [CH/ENT] to view the contents.
 - To view another message, push [CLR] to return to the previous screen. And then, select the desired message.
- ⑤ Push [Home]  to return to the Main screen.

■ Transmitted Call log

The transceiver automatically stores up to 50 transmitted calls, and the logs can be used as a supplement to your logbook.

Software Key functions in the Transmitted Call Log screen:

[Home]: Push to return to the Main screen.

[Delete]: Push to delete the selected message.

[INFO]: Push to display the detailed information.

[MMSI]: Push to save the MMSI as an Individual ID.

[Print]: Push to print out the selected message when a printer is connected to the transceiver.

- ① Push [MENU].
- ② Select "Transmitted Call Log."
(DSC Log > **Transmitted Call Log**)

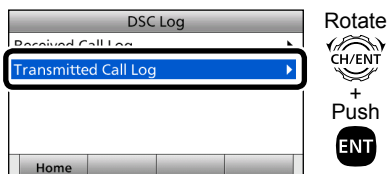

- ③ Select the desired message, then push [ENT].

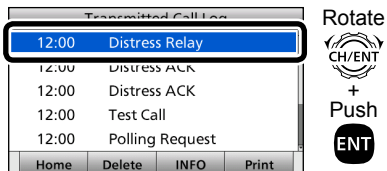

- ④ Rotate [CH/ENT] to view the contents.
 - To view another message, push [CLR] to return to the previous screen. And then, select the desired message.
- ⑤ Push [Home]  to return to the Main screen.

■ DSC settings

- ◇ Position Input (See page 31)
- ◇ Individual ID (See page 29)
- ◇ Group ID (See page 30)

◇ Automatic Acknowledgment

You can set the Automatic Acknowledgment function to acknowledge DSC calls.

When you receive an Individual call, Position Request call, Polling Request call or Test call, the transceiver automatically sends each acknowledgment, if “Auto” is set.

When you set the “Individual ACK” item to “Auto (Unable),” and receive the Individual call, the transceiver automatically sends the acknowledgment, including “ACK (Unable)” (No Reason Given).

- ① Push [MENU].
- ② Select the desired item.
(Settings > DSC > **Individual ACK**)
(Settings > DSC > **Position ACK**)
(Settings > DSC > **Polling ACK**)
(Settings > DSC > **Test ACK**)
- ③ Select the desired option, then push [ENT].

Individual ACK

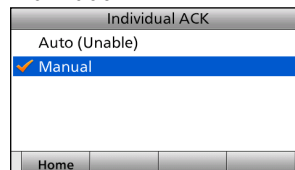

(Default: Manual)

Position ACK

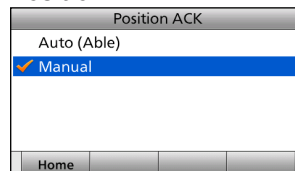

(Default: Manual)

Polling ACK

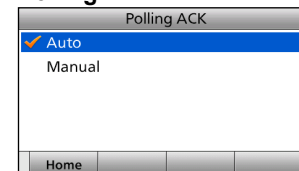

(Default: Auto)

Test ACK

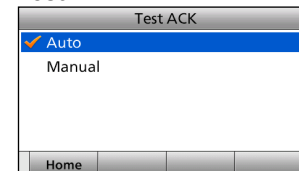

(Default: Auto)

- ④ Push [MENU] to return to the Main screen.

■ DSC settings (Continued)

◇ Setting the “Medical Transports” item display option

You can select whether the “Medical Transports” item is displayed in the Compose Non-Distress screen or not.

- ① Push [MENU].
- ② Select “Medical Transports,” then push [ENT].
(Settings > DSC > **Medical Transports**)
- ③ Select the desired option, then push [ENT].
 - ON: Displayed in the Compose Non-Distress screen.
 - OFF: Not displayed in the Compose Non-Distress screen. (Default)
- ④ Push [MENU] to return to the Main screen.

◇ Setting the “Ships and Aircraft” item display option

You can select whether the “Ships and Aircraft” item is displayed in the Compose Non-Distress screen or not.

- ① Push [MENU].
- ② Select “Ships and Aircraft,” then push [ENT].
(Settings > DSC > **Ships and Aircraft**)
- ③ Select the desired option, then push [ENT].
 - ON: Displayed in the Compose Non-Distress screen.
 - OFF: Not displayed in the Compose Non-Distress screen. (Default)
- ④ Push [MENU] to return to the Main screen.

◇ Setting the CH Auto Switch

Selects whether or not to automatically switch to channel 16 or the specified channel, or hold the call.

- ① Push [MENU].
- ② Select “CH Auto Switch,” then push [ENT].
(Settings > DSC > **CH Auto Switch**)
- ③ Select the desired option, then push [ENT].
 - Accept after 10 sec.:
After receiving a DSC call, the transceiver remains on the operating channel for 10 seconds. After that, the transceiver automatically switches to the channel that is specified on the DSC call. (Default)
 - Hold after 10 sec.:
After receiving a DSC call, if [Accept]  is not pushed within 10 seconds, the transceiver holds the call as a DSC task and remains on the current operating channel.
 - Manual:
After receiving a DSC call, you can select whether or not to accept the received DSC call.
- ④ Push [MENU] to return to the Main screen.

◇ Setting the DSC Data Output

When receiving a DSC call from the station that is selected in this setting, the transceiver outputs the DSC data to the NMEA output port.

You can send Distress calls despite of this setting.

- ① Push [MENU].
- ② Select "DSC Data Output," then push [ENT].
(Settings > DSC > **DSC Data Output**)
- ③ Select the desired option, then push [ENT].
 - All Stations: From any station.
 - Stations List: From the stations that are entered Individual ID or Group ID on the Menu screen.
 - OFF: Does not output any DSC data to an external device. (Default)
- ④ Push [MENU] to return to the Main screen.

◇ Setting the Alarm Status

This item is not displayed when the BAM function is turned ON. (p. 88)

- **Safety**
- **Routine**

Selects whether or not to sound an alarm when receiving the Safety or Routine DSC call.

- ① Push [MENU].
- ② Select the desired item, then push [ENT].
(Settings > DSC > Alarm Status > **Safety**)
(Settings > DSC > Alarm Status > **Routine**)
- ③ Select the desired option, then push [ENT].
 - ON: An alarm sounds. (Default)
 - OFF: An alarm does not sound.
- ④ Push [MENU] to return to the Main screen.

- **Warning**

Selects whether or not to sound an alarm:

- When no MMSI code is entered.
- When the position data has not been updated for 10 minutes.
- When the position data has not been manually updated for 4 hours.
- After the invalid GPS position data or manually entered position data has not been updated for 23.5 hours.

- ① Push [MENU].
- ② Select "Warning," then push [ENT].
(Settings > DSC > Alarm Status > **Warning**)
- ③ Select the desired option, then push [ENT].
 - ON: An alarm sounds. (Default)
 - OFF: An alarm does not sound.
- ④ Push [MENU] to return to the Main screen.

8 DSC OPERATION

■ DSC settings (Continued)

◇ Setting the Alarm Status (Continued)

• **Self-Terminate**

Selects whether or not to sound an alarm when receiving the same Distress call.

- ① Push [MENU].
- ② Select "Self-Terminate," then push [ENT].
(Settings > DSC > Alarm Status > **Self-Terminate**)
- ③ Select the desired option, then push [ENT].
 - ON: An alarm sounds. (Default)
 - OFF: An alarm does not sound.
- ④ Push [MENU] to return to the Main screen.

• **Discrete**

Selects whether or not to sound an alarm when receiving a lower priority DSC call while receiving a higher priority call.

- ① Push [MENU].
- ② Select "Discrete," then push [ENT].
(Settings > DSC > Alarm Status > **Discrete**)
- ③ Select the desired option, then push [ENT].
 - ON: An alarm sounds. (Default)
 - OFF: An alarm does not sound.
- ④ Push [MENU] to return to the Main screen.

◇ Setting the Channel 70 Squelch level

Sets the squelch level on Channel 70. The transceiver has 11 squelch levels between 1 (loose squelch), 10 (tight squelch) and 'Open' (squelch is completely open).

- ① Push [MENU].
- ② Select "CH 70 SQL Level," then push [ENT].
(Settings > DSC > **CH 70 SQL Level**)
- ③ Adjust the squelch level until the noise just disappears.

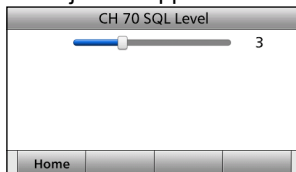

- ④ Push [MENU] to return to the Main screen.

◇ Auto Print

Selects whether or not to enable the Automatic Print Out function when a DSC call is received. The received DSC call content is printed out if a printer is connected to the transceiver.

- ① Push [MENU].
- ② Select "Auto Print," then push [ENT].
(Settings > DSC > **Auto Print**)
- ③ Select the desired option, then push [ENT].
 - ON: The received DSC call content is printed out.
 - OFF: The received DSC call content is not printed out. (Default)
- ④ Push [MENU] to return to the Main screen.

◇ Self Check Test

The Self Check Test sends DSC signals to the receiving AF circuit to compare the sending and receiving signals at the AF level.

- ① Push [MENU].
- ② Select "Self Check Test," then push [ENT].
(Settings > DSC > **Self Check Test**)
- ③ Push [ENT] to start the Self Check Test.

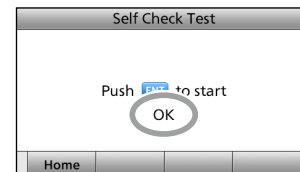
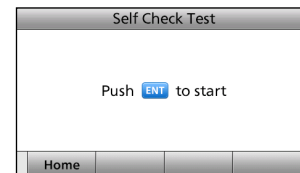

- When the sending and receiving DSC signals match, "OK" is displayed.
- ④ Push [MENU] to return to the Main screen.

■ Menu items

The Menu screen is constructed in a tree structure. (p. 87)

See page 12 to enter the Menu screen.

The following items are described in each section.
Refer to the specified pages for details.

◇ Compose Distress (p. 87)

◇ Compose Non-Distress

- Individual call (p. 48)
- All Ships (p. 51)
- Group (p. 52)
- Position (p. 53)
- Test (p. 56)
- Medical Transports (p. 58)
- Ships and Aircraft (p. 59)

◇ Compose DROBOSE (p. 42)

◇ Task List (p. 34)

◇ GPS Information (p. 83)

◇ DSC Log (pp. 69, 70)

◇ BAM List (p. 24)

◇ Settings (p. 87)

• Configuration (p. 83)

Item	Ref.	Item	Ref.
Display	p. 83	Inactivity Timer	p. 86
Backlight	p. 83	Not DSC Related	p. 86
Mode	p. 83	DSC Related	p. 87
Night Mode Time	p. 84	Distress Related	p. 87
Key Beep	p. 85	RT Related	p. 87
Key Assignment	p. 85	Position Data Output	p. 88
Softkey 1 ~ 12	p. 85	BAM	p. 88
Set Default	p. 85	Function	p. 88
UTC Offset	p. 86	Internal Speaker	p. 89
		MIC Type	p. 89

• Radio (p. 90)

Item	Ref.	Item	Ref.
Scan Type	p. 90	Favorite Channel	p. 91
Scan Timer	p. 90	FAV on MIC	p. 91
Dual/Tri-Watch	p. 90	Channel Display	p. 91
Call Channel	p. 90		

• DSC (p. 77)

◇ Radio Information (p. 91)

■ GPS Information

Displays your position, date, time, Speed Over Ground (SOG), and Course Over Ground (COG).

■ Configuration settings

◇ Display

(Settings > Configuration > Display)

Sets the Display settings.

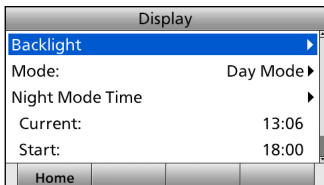

• Backlight

(Settings > Configuration > Display > **Backlight**)

Sets the backlight brightness to between 1 and 7, or OFF*. (Default: 7)

* "OFF" is selectable only in Day Mode.

- Day Mode: Sets the backlight brightness for Day Mode.
- Night Mode: Sets the backlight brightness for Night Mode.

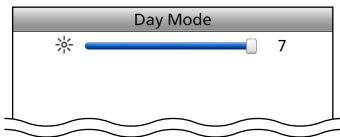

• Mode

(Settings > Configuration > Display > **Mode**)

Sets the Backlight mode.

- Day Mode: For the daytime operation, and the screen items are in color. (Default)
- Night Mode: For the nighttime operation, and the screen items are in black and red.
- Auto: Automatically sets the Backlight mode to Night Mode for the period of time that is set in Night Mode Time.

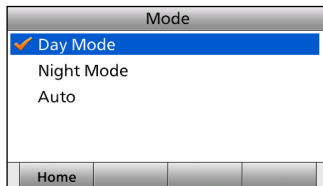

9 MENU ITEMS

■ Configuration settings (Continued)

◇ Display (Continued)

• **Night Mode Time**

(Settings > Configuration > Display > **Night Mode Time**)

Sets the period of time that the Backlight mode is automatically set to Night Mode when the “Mode” item is set to “Auto.”

- **Current:** Enters the current time (if it is incorrect).
 - The current time is displayed when valid GPS data is received, or your UTC time is manually entered in the “Position Input.” (p. 31)
- **Start:** Enters the time that Night Mode starts. (Default: 18:00)
- **End:** Enters the time that Night Mode ends. (Default: 06:00)

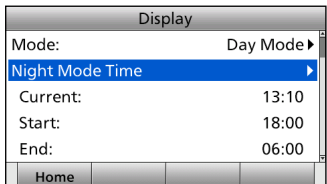

- ① Enter the current time (if it is incorrect.)

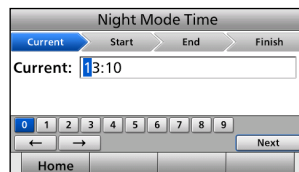

Push



- ② After entering, select “Next,” and then push [ENT] to save the selected number.
- ③ Enter the start time and the end time.

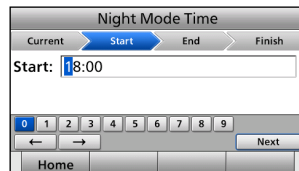

Push

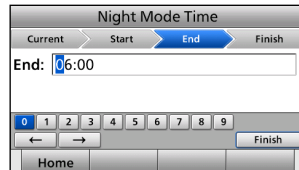

Push



- ④ After entering, select “Finish,” and then push [ENT] to set the entered time.
 - Returns to the previous screen.

◇ **Key Beep**

(Settings > Configuration > **Key Beep**)

Turns the Key Beep function ON or OFF.

- ON: Sounds a beep when pushing a key. (Default)
- OFF: Does not sound a beep when pushing a key for silent operation.

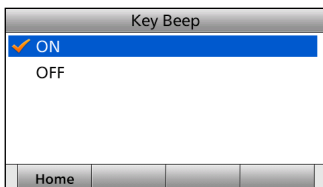

◇ **Key Assignment**

(Settings > Configuration > **Key Assignment**)

Assigns Software Key functions.

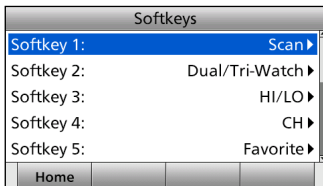

• **Softkey 1 ~ 12**

(Settings > Configuration > Key Assignment > **Softkey 1 ~12**)

You can change which Software Key functions to display, and their order. You can assign up to 12 Software Keys at a time.

- You cannot change “Compose Distress,” “Compose Non-Distress,” “Compose DROBOSE,” and “Task List” Software Keys to other Software Key functions.
- The usable Software Key functions and their order may differ, depending on the presetting.
- Some Software Keys may not be usable, depending on other item settings. (“X” is displayed at the right of an unusable key name.)



• **Set Default**

(Settings > Configuration > Key Assignment > **Set Default**)

Sets the Software Key function order as the default.

- The default setting may differ, depending on the presetting.

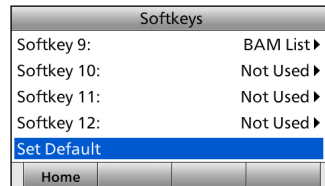

9 MENU ITEMS

■ Configuration settings (Continued)

◇ UTC Offset

(Settings > Configuration > **UTC Offset**)

Sets the offset time between UTC (Universal Time Coordinated) and your local time to between -14:00 and +14:00 (in 1 minute steps). (Default: 00:00)

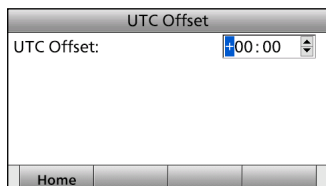

◇ Inactivity Timer

(Settings > Configuration > **Inactivity Timer**)

Sets the inactivity timer to between 1 and 15 minutes (in 1 minute steps) or OFF.

The count down alarm sounds 10 seconds before the Inactive timer activates.

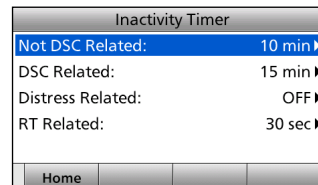

• Not DSC Related

(Settings > Configuration > Inactivity Timer > **Not DSC Related**)

The transceiver automatically returns to the Main screen if no key is pushed for this set time period. (Default: 10 min)

This setting is for when the LCD displays a screen that is not related to DSC screen other than the Main screen.



• **DSC Related**

(Settings > Configuration > Inactivity Timer > **DSC Related**)

The transceiver automatically returns to the Main screen if no key is pushed for this set time period. (Default: 15 min)

This setting is for when the LCD displays a screen that is related to DSC.

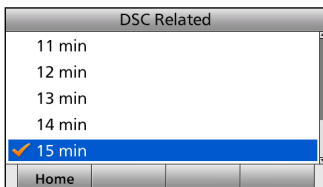

• **Distress Related**

(Settings > Configuration > Inactivity Timer > **Distress Related**)

The transceiver automatically returns to the Main screen if no key is pushed for this set time period. (Default: OFF)

This setting is for when the LCD displays a screen that is related to a Distress call.

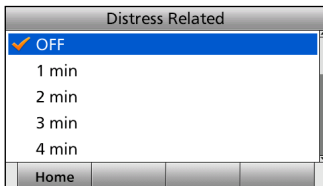

• **RT Related**

(Settings > Configuration > Inactivity Timer > **RT Related**)

The transceiver automatically returns to the standby mode if you push no key for this set time period. (Default: 30 sec)

This setting is for when the transceiver is in the Radio Telephone mode.

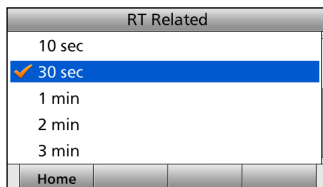

9 MENU ITEMS

■ Configuration settings (Continued)

◇ Position Data Output

(Settings > Configuration > NMEA Data Output > **Position Data Output**)

Selects whether or not to output your position data from the NMEA 0183 output port.

- ON: Outputs the position data.
- OFF: Does not output the position data. (Default)

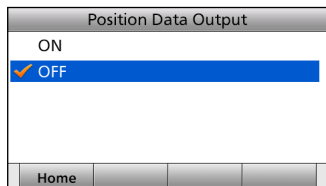

◇ BAM

(Settings > Configuration > **BAM**)

Sets the BAM function.

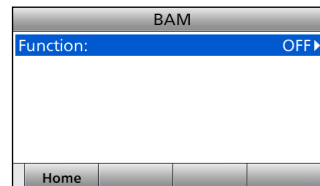

• Function

(Settings > Configuration > BAM > **Function**)

Selects whether or not to use the Bridge Alert Management (BAM) function. (p. 20)

- ON: Turns ON the BAM function.
- OFF: Turns OFF the BAM function. (Default)

You cannot receive alerts related to the BAM function.
The BAM List is not displayed in the Menu screen.

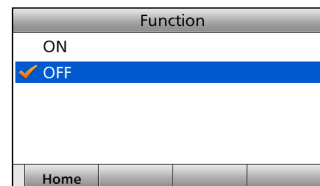

◇ **Internal Speaker**

(Settings > Configuration > **Internal Speaker**)

Turns the internal speaker ON or OFF.

When you want to mute the internal speaker, select “OFF.” An external speaker must be connected when “OFF” is selected, otherwise you will not hear any received communication audio.

- ON: Turns ON the internal speaker. (Turns OFF an external speaker if connected.) (Default)
- OFF: Turns OFF the internal speaker. (Turns ON an external speaker if connected.)

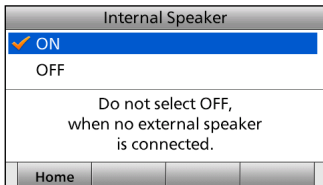

◇ **MIC Type**

(Settings > Configuration > **MIC Type**)

Selects the desired microphone type.

- HM-214V: To use the supplied microphone. (Default)
- HS-98: To use the optional handset.

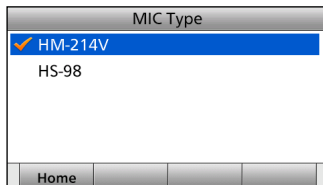

IMPORTANT: When using the optional HS-98.

First set this item to “HS-98.” Then, turn OFF the transceiver, and connect the HS-98. (p. 98) After turning ON the transceiver again, you can use the HS-98.

- If this item is set to “HM-214V,” and when the HS-98 is connected, the transceiver’s keys are disabled.

■ Radio settings

◇ Scan Type

(Settings > Radio > **Scan Type**)

Selects the desired Scan type to locate signals. (p. 26)

- Normal Scan: Sequentially searches all Favorite channels.
- Priority Scan: Sequentially searches all Favorite channels, while also monitoring Channel 16. (Default)

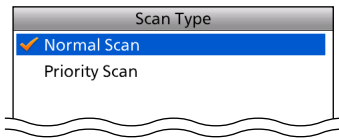

◇ Scan Timer

(Settings > Radio > **Scan Timer**)

Turns the Scan Resume timer ON or OFF.

- ON: When a signal is detected on a channel, the scan pauses for 5 seconds, and then resumes. If the signal disappears in less than 5 seconds, the scan immediately resumes.
- OFF: When a signal is detected on a channel, the scan pauses until the signal disappears, and then resumes. (Default)

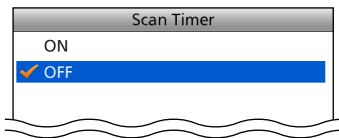

◇ Dual/Tri-Watch

(Settings > Radio > **Dual/Tri-Watch**)

Selects the desired watch type. (p. 28)

- Dualwatch: The transceiver monitors Channel 16, while listening or talking on another channel. (Default)
- Tri-watch: The transceiver monitors Channel 16 and the Call channel, while listening or talking on another channel.



◇ Call Channel

(Settings > Radio > **Call Channel**)

You can set the Call channel with your most often-used channel for quick recall. (p. 14) (Default: Channel 16)

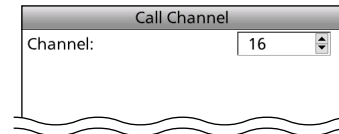

◇ **Favorite Channel**

(Settings > Radio > **Favorite Channel**)

Sets the Favorite channel settings.

- Set All Channels: Sets all channels as Favorite channels.
- Clear All Channels: Clears all Favorite channels.
- Set Default: Returns to the default setting.

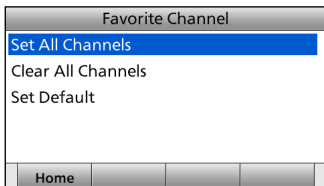

◇ **FAV on MIC**

(Settings > Radio > **FAV on MIC**)

Turns the FAV on MIC function ON or OFF.

- ON: Pushing [▲] or [▼] on the supplied microphone scrolls up and down through only the Favorite channels. (Default)
- OFF: Pushing [▲] or [▼] on the supplied microphone scrolls up and down through all channels.

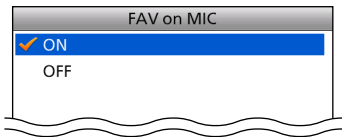

◇ **Channel Display**

(Settings > Radio > **Channel Display**)

You can select the number of digits to display the channel number.

- This setting may not be usable, depending on the presetting.
- 3 digits: The channel number is displayed in 3 digits, such as "01A."
- 4 digits: The channel number is displayed in 4 digits, such as "1001." (Default)

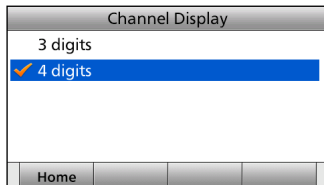

■ **Radio Information**

Displays your transceiver's information as shown below.

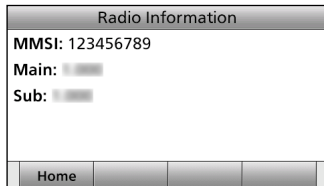

10 CONNECTIONS AND MAINTENANCE

■ Connections

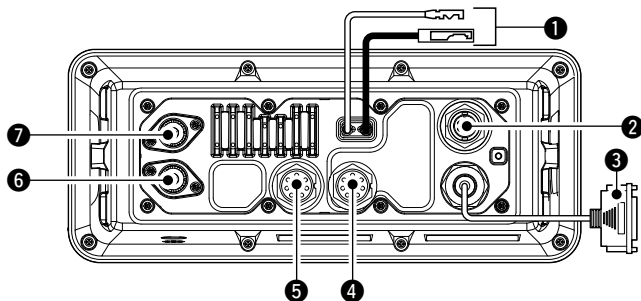

1 DC POWER CONNECTOR

Connects the PS-310 with the DC power cable of the PS-310. (p. 96)

CAUTION: After connecting the DC power cable, cover the connector with a tape, as shown below, to prevent water seeping into the connection.

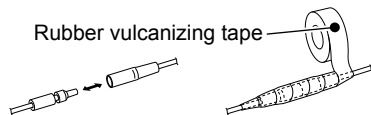

2 EXTERNAL SPEAKER/VDR CONNECTOR

Connects to a voice recorder or an external speaker. Use the supplied accessory connector for connections. See page 95 for details.

- Lead: Thicker than 0.75 sq mm,
Length: Shorter than 1.5 m is recommended.



*VDR: Voyage Data Recorder

3 D-SUB 25-PIN

Connects to a printer (IBM® centronics or compatible) to print out the received DSC call contents.

4 REMOTE ALARM CONNECTOR

Use the supplied accessory connector for connections. See page 95 for details.

Remote alarm output terminal

- 4 V DC*
- Maximum 10 mA*

*When the external equipment is connected between this terminal and the GND terminal.

When DSC call that is related to “Distress” as described below is received, 4 V DC is output and the key backlight blinks.

- Distress call
- Distress acknowledgment
- Distress Relay call
- Distress Relay acknowledgment
- Distress Cancel call
- DSC call whose category is “Distress”

Remote alarm input terminal

When this terminal shorts to the GND terminal, the transceiver sends the Distress call.

This terminal can be used as an external distress switch.

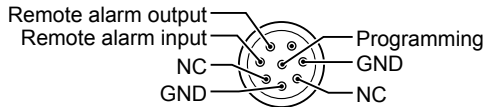

5 IEC61162-1 CONNECTOR

Use the supplied accessory connector for connections. See page 95 for details.

- Connects to IEC61162-1 Out lines of a PC or IEC61162-1 sentence format DSC or DSE compatible navigation equipment, to receive position data from other ships.
- Connects to IEC61162-1 In lines of a GPS receiver for position data.
 - A GPS receiver compatible with IEC61162-1 format RMC, GGA, GNS, or GLL and VTG sentences is required. Ask your dealer about suitable GPS receivers.
- Connects to BAM In/Out lines of the CAM system to send the transceiver's BAM information to the CAM system.

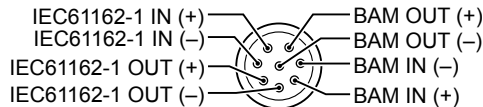

6 ANTENNA CONNECTOR (to receive on Channel 70)

7 ANTENNA CONNECTOR

Connects to a marine VHF antenna with a PL-259 connector.

CAUTION: DO NOT transmit without an antenna.

◇ IEC61162-1 In/Out lines' specifications

PIN	SPECIFICATIONS
IEC61162-1 OUT (+)	Output level: 5 V/40 mA maximum (RS-422 balanced type)
IEC61162-1 OUT (-)	
BAM OUT (+)	
BAM OUT (-)	
IEC61162-1 IN (+)	Input level: Less than 2 mA (at 2 V applied)
IEC61162-1 IN (-)	
BAM IN (+)	
BAM IN (-)	

10 CONNECTIONS AND MAINTENANCE

■ Connections (Continued)

◇ Software maintenance

The Icom customer support center provides the firmware file for the transceiver's maintenance. You can update the transceiver's firmware through a PC.

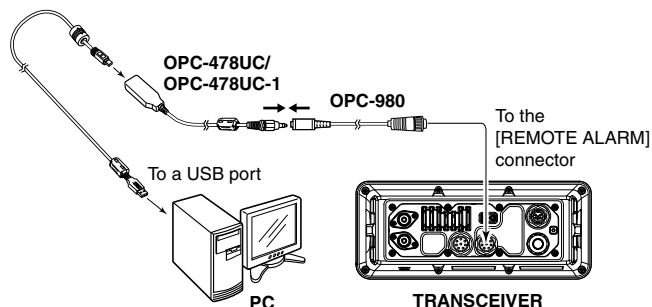

■ Antenna

A key element in the performance of any communication system is the antenna. Ask your dealer about antennas and the best place to mount them.

■ Fuse replacement

One fuse is installed in the supplied DC power cable. If the fuse blows, track down the source of the problem, repair it, and replace the damaged fuse with a new one of the proper rating.

Fuse rating: 250 V/10 A (OPC-891A)
250 V/15 A (OPC-2352)

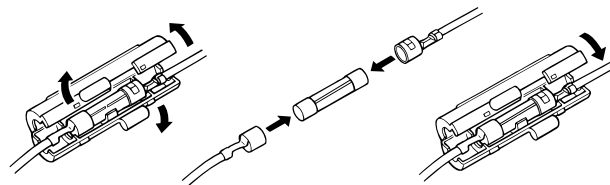

■ Cleaning

If the transceiver becomes dusty or dirty, wipe it clean with a soft, dry cloth.





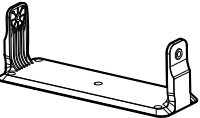

DO NOT use harsh solvents such as Benzine or alcohol, as they will damage transceiver surfaces.

■ Supplied accessories

Mounting bracket



For the mounting bracket

Knob bolts	Flat washers (M5)
	
Screws (5 × 20 mm)	Spring washers (M5)
	

Microphone



Sponges



Accessory connectors



6 pin 8 pin

Microphone hanger and screws (3 × 16 mm)



DC power cable (OPC-891A)*1



*1 Used for the transceiver's operation check. (12 V DC only)

The following items are sold as a set with the GM600.

PS-310

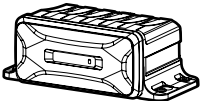

Screws (5 × 20 mm)



Spring washers (M5)



Spare fuse (FGB 15 A)



Flat washers (M5)



DC power cable (OPC-2352)



Ferrite EMI filter + Tie wrap



◇ Accessory connectors set up

The accessory connectors are used on the accessory cables (User supplied) to connect the EXTERNAL SPEAKER/VDR CONNECTOR, the REMOTE ALARM CONNECTOR, or the IEC61162-1 CONNECTOR. (pp. 93, 92)

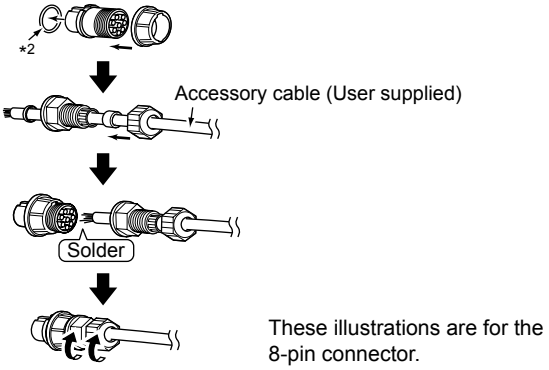

10 CONNECTIONS AND MAINTENANCE

■ Power source connections

◇ Connecting to the DC power source through the PS-310

To operate the GM600, you must connect it to a 12 or 24 volt DC power source through the PS-310 DC-DC POWER SUPPLY, sold as a set with the GM600.

The PS-310 converts the input voltage from the 12 or 24 volt DC power source, then provides stable 12.6 V DC, 5.5 A of continuous power to the transceiver.

Select the appropriate version for your vessel power system.

• PS-310

Version	Input voltage	Output voltage
#11	21.6 to 31.2 V DC	12.6 V DC
#12	10.8 to 15.6 V DC	12.6 V DC

CAUTION:

Before connecting the DC power cable, confirm the transceiver is OFF, and the DC power cable polarity is correct.

- Red: positive + terminal
- Black: negative - terminal

BE SURE to connect only the DC power cable from the PS-310, and **DO NOT** extend the cable length.

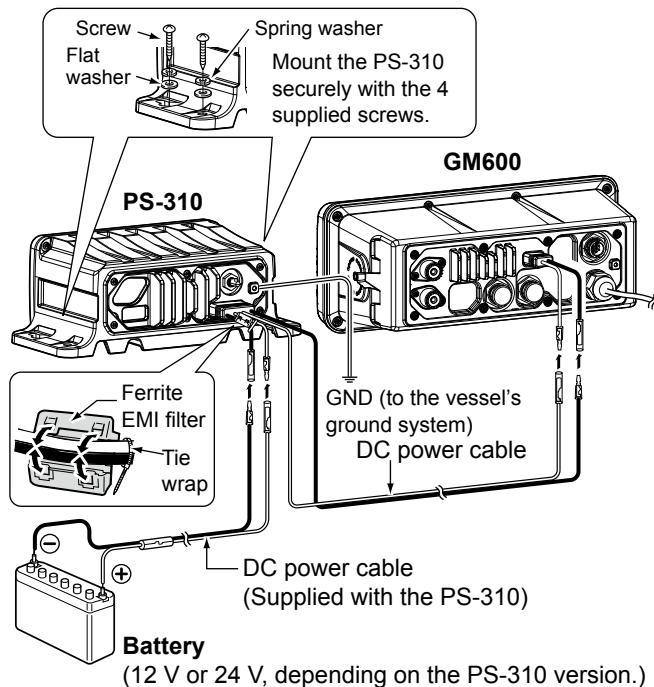

■ Mounting the transceiver

The supplied universal mounting bracket with your transceiver enables overhead or flat mounting.

- Mount the transceiver securely with the 5 supplied screws (5 × 20 mm) to a surface that is more than 10 mm thick and can support more than 5 kg.
- Mount the transceiver so its face is at 90° to your line of sight when operating.

CAUTION: Keep the transceiver and microphone at least 1 meter away from your vessel's magnetic navigation compass.

NOTE:

- Check the installation angle; the function display may not be easy to read at some angles.
- When mounting the transceiver on the place that is prone to strong vibration, use the supplied sponges between the transceiver and mounting bracket to reduce the effect of the vibration.

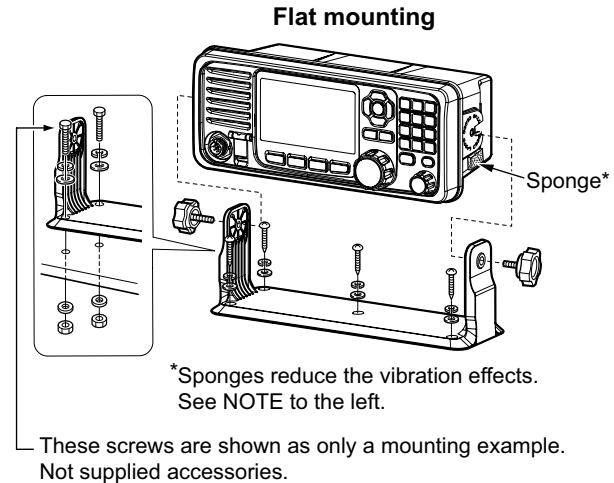

■ Handset (HS-98)

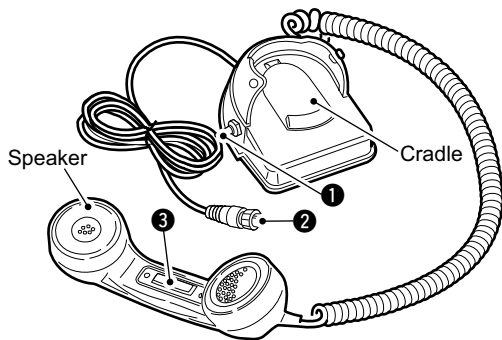

IMPORTANT: When using the optional HS-98

First set the “MIC Type” item to “HS-98.” (p. 89) Then, turn OFF the transceiver, and connect the HS-98. After turning ON the transceiver again, you can use the HS-98.

① SPEAKER SWITCH

When the switch is set to the “☐” position:

You can hear the received audio from the internal or external speaker.*

When the switch is set to the “▽” position:

Mutes the internal or external speaker* output.

• You can hear the received audio from the handset.

Put the handset into the cradle to output the received audio from the internal or external speaker.*

HS-98		The received audio is heard from:	
Status	Speaker switch	GM600 internal or external speaker*	HS-98
On hook	☐	Yes	Yes
	▽	Yes	No
Off hook	☐	Yes	Yes
	▽	No	Yes

* Depending on the Internal Speaker setting. (p. 89)

② HANDSET CONNECTOR

Insert the connector into the [MIC CONNECTOR] on the front panel.

③ PTT SWITCH [PTT]

Hold down to transmit, release to receive.

◇ Connection

Insert the connector into the [MIC CONNECTOR] on the front panel, and tighten the cable nut, as shown below.

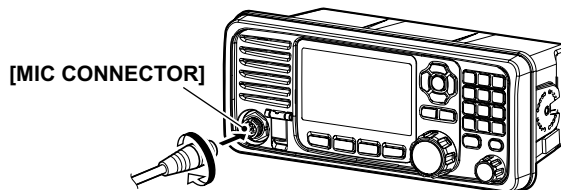

■ Specifications

This specification is described when the GM600 is used with the PS-310 DC-DC POWER SUPPLY.

All stated specifications are subject to change without notice or obligation.

◇ General

- Frequency coverage: TX 156.025 ~ 161.600 MHz
RX 156.300 ~ 162.000 MHz
156.525 MHz (CH70/DSC)
 - Mode: FM (16K0G3E), DSC (16K0G2B)
 - Operating temperature range: -15°C to +55°C
 - Current drain (at 24 V): TX high (25 W) 3.3 A
Maximum audio 2.0 A
 - Power supply requirement: 12/24 V DC (negative ground)
PS-310 Input voltage: 21.6 to 31.2 V (#11)
10.8 to 15.6 V (#12)
 - Frequency error: ±0.5 kHz (-15°C to +55°C)
 - Antenna impedance: 50 Ω nominal (Unbalanced)
 - Dimensions (Projections not included):
GM600: 274 (W) × 114 (H) × 121.5 (D) mm
PS-310: 216 (W) × 79 (H) × 110 (D) mm
 - Weight (approximately):
GM600: 1.6 kg
PS-310: 930 g
 - BAM function type: P
- ### ◇ Transmitter
- Output power: 25 W or 1 W
 - Modulation system: Variable reactance frequency modulation

- Maximum frequency deviation: ±5.0 kHz
- Spurious emissions: Less than 0.25 μW
- Adjacent channel power: More than 70 dB
- Audio harmonic distortion: Less than 10%
(at 1 kHz, 60% deviation)
- Residual modulation: More than 40 dB
- Audio frequency response: +1 to -3 dB of 6 dB/octave range from 300 Hz to 3000 Hz

◇ Receiver

- Receive system: Double conversion superheterodyne
- Sensitivity:
FM: -7 dBμ emf (typical) (20 dB SINAD)
DSC (CH70): -7 dBμ emf (typical) (1% BER)
- Squelch sensitivity: Less than -2 dBμ
- Intermodulation: More than 75 dB
More than 73 dBμ emf (CH70/DSC)
- Spurious response: More than 75 dB
More than 73 dBμ emf (CH70/DSC)
- Adjacent channel selectivity: More than 75 dB
More than 73 dBμ emf (CH70/DSC)
- Audio output power (at 10% distortion):
Internal: More than 3.5 W*
*More than 2 W if an external speaker (4 Ω) is connected.
External: More than 10 W with 4 Ω load
- Ham and noise: More than 40 dB
- Audio frequency response: +1 to -3 dB of -6 dB/octave range from 300 Hz to 3000 Hz

11 SPECIFICATIONS AND OPTIONS

■ Dimensions

(Unit: mm)

GM600

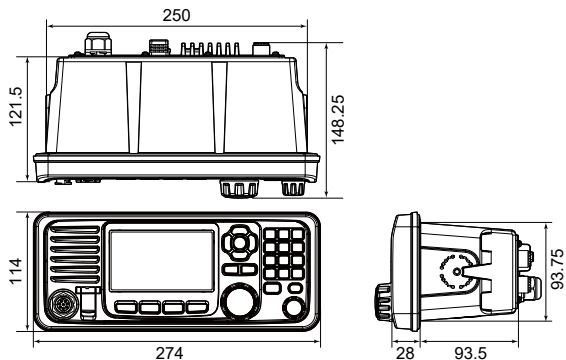

PS-310

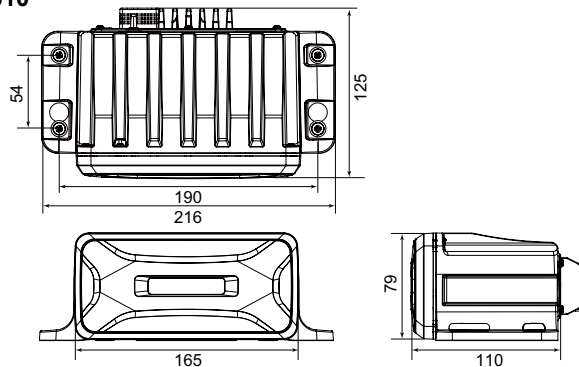

■ Options

• PS-310 DC-DC POWER SUPPLY

Provides stable 12.6 V DC output converted from a DC power source.

Version	Input voltage	Output voltage
#11	21.6 to 31.2 V DC	12.6 V DC
#12	10.8 to 15.6 V DC	12.6 V DC

• HS-98 HANDSET

Provides clear audio reception during offshore conditions and comes in handy for listening privacy on board.

• HM-214V MICROPHONE

Equipped with [▲]/[▼] (channel up/down), [H/L], [16/C], and [PTT] keys, and a microphone.

* The same microphone as the microphone supplied with the transceiver.

• CS-GM600 PROGRAMMING SOFTWARE

• OPC-980 PROGRAMMING ADAPTER CABLE

• OPC-478UC/OPC-478UC-1 PROGRAMMING CABLE

PROBLEM	POSSIBLE CAUSE	SOLUTION	REF.
The transceiver does not turn ON.	<ul style="list-style-type: none"> • Bad connection to the power supply. • Fuse blows. 	<ul style="list-style-type: none"> • Check the connection to the transceiver and power supply. • Repair the problem, and then replace the fuse. 	<p>p. 96</p> <p>p. 94</p>
Little or no sound comes from the speaker.	<ul style="list-style-type: none"> • Squelch level is set too high. • Volume level is set too low. • The internal speaker is OFF. 	<ul style="list-style-type: none"> • Set the squelch to the threshold point. • Set the volume to a suitable level. • Turn ON the internal speaker. 	<p>p. 15</p> <p>p. 15</p> <p>p. 89</p>
You cannot transmit, or cannot select high power.	<ul style="list-style-type: none"> • Some channels are set for low power or receive only by regulations. • The output power is set to low. 	<ul style="list-style-type: none"> • Change channels. • Push [HI/LO] to select high power. 	<p>pp. 13, 103</p> <p>p. 15</p>
Scan does not start.	<ul style="list-style-type: none"> • More than 2 favorite channels are not set. 	<ul style="list-style-type: none"> • Set the desired channels as Favorite channels. 	<p>pp. 27, 91</p>
No beep sounds.	<ul style="list-style-type: none"> • The Key Beep function is OFF. 	<ul style="list-style-type: none"> • Turn ON the Key Beep function. 	<p>p. 85</p>
The Main screen is not displayed at power ON.	<ul style="list-style-type: none"> • MMSI (DSC self ID) code is not set. 	<ul style="list-style-type: none"> • Set the MMSI (DSC self ID) code. 	<p>p. 9</p>
Individual or Group ID cannot be set.	<ul style="list-style-type: none"> • The entered ID code is incorrect. First digit must be set to between '1' and '9' for the Individual ID. First digit must be set to '0' for the Group ID. 	<ul style="list-style-type: none"> • Enter a correct ID code. 	<p>pp. 29, 30</p>
"??" blinks instead of the position and time.	<ul style="list-style-type: none"> • 4 hours have passed after you manually entered the position. • The GPS position is invalid. 	<ul style="list-style-type: none"> • Enter the position. 	<p>p. 31</p>

12 TROUBLESHOOTING

PROBLEM	POSSIBLE CAUSE	SOLUTION	REF.
“NO POSITION” and “NO TIME” are displayed instead of the position and time.	<ul style="list-style-type: none"> • A GPS receiver is not correctly connected. • The position and time have not been manually entered. 	<ul style="list-style-type: none"> • Check the GPS receiver connection. • Enter the position and time. 	p. 92 p. 31
Sensitivity is too low, and only strong signals can be heard.	<ul style="list-style-type: none"> • The antenna is defective or the coaxial cable connector is shorted or cut. 	<ul style="list-style-type: none"> • Repair the problem and then reconnect to the antenna connector. 	p. 92
The communication cannot be established.	<ul style="list-style-type: none"> • The antenna is defective or the coaxial cable connector is shorted or cut. 	<ul style="list-style-type: none"> • Repair the problem and then reconnect to the antenna connector. 	p. 92
The received DSC call content is not printed out.	<ul style="list-style-type: none"> • The printer is not correctly connected, or the paper is exhausted. 	<ul style="list-style-type: none"> • Check the printer connection or paper. 	p. 92
The Voyage Data has not been recorded.	<ul style="list-style-type: none"> • The Voyage Data Recorder (VDR) is not correctly connected. 	<ul style="list-style-type: none"> • Check the VDR connection. 	p. 92
The transceiver is locked up, and does not respond.	<ul style="list-style-type: none"> • A software error has occurred. 	<ul style="list-style-type: none"> • Turn OFF the DC power source, and then turn it ON again. 	p. 96
The transceiver does not work.	<ul style="list-style-type: none"> • The transceiver's Phase Lock Loop is unlocked. 	<ul style="list-style-type: none"> • Contact your dealer. 	—
An alert is not received. (An icon such as “  ” is not displayed in the information area and/or on the popup screen.)	<ul style="list-style-type: none"> • The BAM function is turned OFF by default. 	<ul style="list-style-type: none"> • Turn ON the BAM function. 	pp. 20, 88

• International channels

CH	Frequency (MHz)		CH	Frequency (MHz)		CH	Frequency (MHz)		CH	Frequency (MHz)		CH	Frequency (MHz)	
	Transmit	Receive		Transmit	Receive		Transmit	Receive		Transmit	Receive		Transmit	Receive
01	156.050	160.650	16	156.800	156.800	1027	157.350	157.350	74	156.725	156.725	85	157.275	161.875
02	156.100	160.700	17 ^{*1}	156.850	156.850	1028	157.400	157.400	75 ^{*2}	156.775	156.775	86	157.325	161.925
03	156.150	160.750	18	156.900	161.500	60	156.025	160.625	76 ^{*2}	156.825	156.825	87	157.375	157.375
04	156.200	160.800	19	156.950	161.550	61	156.075	160.675	77	156.875	156.875	88	157.425	157.425
05	156.250	160.850	1019	156.950	156.950	62	156.125	160.725	78	156.925	161.525			
06	156.300	156.300	2019	RX only	161.550	63	156.175	160.775	1078	156.925	156.925			
07	156.350	160.950	20	157.000	161.600	64	156.225	160.825	2078	RX only	161.525			
08	156.400	156.400	1020	157.000	157.000	65	156.275	160.875	79	156.975	161.575			
09	156.450	156.450	2020	RX only	161.600	66	156.325	160.925	1079	156.975	156.975			
10	156.500	156.500	21	157.050	161.650	67	156.375	156.375	2079	RX only	161.575			
11	156.550	156.550	22	157.100	161.700	68	156.425	156.425	80	157.025	161.625			
12	156.600	156.600	23	157.150	161.750	69	156.475	156.475	81	157.075	161.675			
13	156.650	156.650	24	157.200	161.800	71	156.575	156.575	82	157.125	161.725			
14	156.700	156.700	25	157.250	161.850	72	156.625	156.625	83	157.175	161.775			
15 ^{*1}	156.750	156.750	26	157.300	161.900	73	156.675	156.675	84	157.225	161.825			

*1 Channels 15 and 17 may also be used for on-board communications provided the effective radiated power does not exceed 1 W, and subject to the national regulations of the administration concerned when these channels are used in its territorial waters.

*2 The output power of channels 75 and 76 are limited to low power (1 W) only. The use of these channels should be restricted to navigation-related communications only, and all precautions should be taken to avoid harmful interference to channel 16, e.g. by means geographical separation.

14 DIGITAL INTERFACE (IEC61162-1)

■ I/O Sentences

◇ Version number

IEC61162-1 Ed.5(2016-08)

◇ Input sentences (IEC61162-1)

RMC, GGA, GNS, GLL, and VTG

◇ Input sentence description

• RMC—Recommended minimum specific GNSS data

\$**RMC, hhmmss.ss, A, llll.ll, a, yyyy.yy, a, x.x, x.x, ddmmyy, x.x, a, a, a*hh<CR><LF>
 1 2 3 4 5 6 7 8 9 10 11 12 13

1	UTC of position fix (000000.00 to 235959.99)	8	Course over ground, degrees true (0.0 to 360.0)
2	Status (A=data valid, V=navigation receiver warning)	9	Date (010100 to 311249)
3	Latitude (0000.0000 to 9000.0000)	10	Magnetic variation, degrees (no use)
4	N/S	11	E/W
5	Longitude (00000.0000 to 18000.0000)	12	Mode indicator (A=Autonomous, D=Differential, F=Float RTK, N=No fix, P=Precise, R=Real Time Kinematic, S=Simulator mode)
6	E/W	13	Navigational status indicator (no use)
7	Speed over ground, knots (0.0 to 100.0)		

• GGA—Global positioning system (GPS) fix data

\$**GGA, hhmmss.ss, llll.ll, a, yyyy.yy, a, x, xx, x.x, M, x.x, M, x.x, xxxx*hh<CR><LF>
 1 2 3 4 5 6 7 8 9 10 11 12 13 14

1	UTC of position (000000.00 to 235959.99)	8	Horizontal dilution of precision (no use)
2	Latitude (0000.0000 to 9000.0000)	9	Antenna altitude above/below mean sealevel (no use)
3	N/S	10	Unit M
4	Longitude (00000.0000 to 18000.0000)	11	Geoidal separation (no use)
5	E/W	12	Unit M
6	GPS quality indicator (1 to 5)	13	Age of differential GPS data (no use)
7	Number of satellites in use (no use)	14	Differential reference station ID (no use)

• **GNS—GNSS fix data**

\$**GNS, hhmmss.ss, llll.ll, a, yyyy.yy, a, c--c, xx, x.x, x.x, x.x, x.x, x.x, a*hh<CR><LF>
 1 2 3 4 5 6 7 8 9 10 11 12 13

1	UTC of position (000000.00 to 235959.99)	8	HDOP (no use)
2	Latitude (0000.0000 to 9000.0000)	9	Antenna altitude, meters (no use)
3	N/S	10	Geoidal separation (no use)
4	Longitude (00000.0000 to 18000.0000)	11	Age of differential data (no use)
5	E/W	12	Differential reference station ID (no use)
6	Mode indicator (N=No fix, A=Autonomous, D=Differential, P=Precise, R=Real Time Kinematic, F=Float RTK, S=Simulator mode)	13	Navigational status indicator (no use)
7	Total number of satellites in use (no use)		

• **GLL—Geographic position – Latitude/longitude**

\$**GLL, llll.ll, a, yyyy.yy, a, hhmmss.ss, a, x*hh<CR><LF>
 1 2 3 4 5 6 7

1	Latitude (0000.0000 to 9000.0000)	5	UTC of position (000000.00 to 235959.99)
2	N/S	6	Status (A=data valid V=data invalid)
3	Longitude (00000.0000 to 18000.0000)	7	Mode indicator (A=Autonomous, D=Differential, N=No fix, S=Simulator mode)
4	E/W		

• **VTG—Course over ground and ground speed**

\$**VTG, x.x, T, x.x, M, x.x, N, x.x, K, a*hh<CR><LF>
 1 2 3 4 5 6 7 8 9

1	Course over ground, degrees true (0.0 to 360.0)	6	Unit N
2	Unit T	7	Speed over ground, km/h (no use)
3	Course over ground, degrees magnetic (no use)	8	Unit K
4	Unit M	9	Mode indicator (A=Autonomous, D=Differential, E=Estimated, M=Manual input, P=Precise, S=Simulator, N=Data not valid)
5	Speed over ground, knots (0.0 to 100.0)		

14 DIGITAL INTERFACE (IEC61162-1)

■ I/O Sentences (Continued)

◇ Output sentences (IEC61162-1)

DSC and DSE

◇ Output interval

DSC, DSE: Irregular output (Output immediately after receiving a DSC call.)

◇ Output sentence description

• DSC—Digital selective calling information

\$CDDSC, xx, xxxxxxxxxx, xx, xx, xx, x.x, x.x, xxxxxxxxxx, xx, a, a*hh<CR><LF>
 1 2 3 4 5 6 7 8 9 10 11

1	Format specifier (2 digits)	7	Time or Telephone Number (Maximum 16 digits)
2	Address (10 digits)	8	MMSI of ship in distress (10 digits or NULL)
3	Category (2 digits or NULL)	9	Nature of distress (2 digits or NULL)
4	Nature of distress or first telecommand (2 digits or NULL)	10	Acknowledgment (R=Acknowledge request, B=Acknowledgment, S=Neither (end of sequence))
5	Type of communication or second telecommand (2 digits)	11	Expansion indicator (E or NULL)
6	Position or Channel/frequency (Maximum 16 digits)		

• DSE—Expanded digital selective calling

\$CDDSE, x, x, a, xxxxxxxxxx, xx, c--c,, xx, c--c*hh<CR><LF>
 1 2 3 4 5 6 7 8 9

1	Total number of sentences (fixed value)	6	Data set '1' (code field, Enhanced position resolution, Maximum 8 characters), NULL
2	Sentence number (fixed value)	7	Additional data sets*, NULL
3	Query/reply flag (fixed value A=Automatic)	8	Data set 'n' (NULL)*
4	Vessel MMSI (10 digits)	9	Data set 'n' (NULL)*
5	Data set '1' (code field, fixed value 00)		

* This transceiver outputs only "Data set 1."

■ BAM Sentences

◇ Version number

IEC61162-1 Ed.5(2016-08)

◇ Input sentences (IEC61162-1)

ACN and HBT

◇ Input sentence description

• ACN—Alert command

\$--ACN, hhmmss.ss, aaa, x.x, x.x, c, a*hh<CR><LF>
 1 2 3 4 5 6

1	Release time of the alert command (000000.00 to 235959.99, or NULL)	4	Alert Instance (1 to 999999, NULL*)
2	Manufacture mnemonic code (NULL)	5	Alert command (A=Acknowledge, Q=Request/Repeat information, O=Responsibility transfer, S=Silence)
3	Alert Identifier (Maximum 7 digits, 0=All alerts)	6	Sentence status flag (C)

* Only when “Alert Identifier” is “0.”

• HBT—Heartbeat supervision sentence

\$--HBT, x.x, A, x*hh<CR><LF>
 1 2 3

1	Configured repeat interval
2	Equipment status (A=Yes, V=No)
3	Sequential sentence identifier (0 to 9)

14 DIGITAL INTERFACE (IEC61162-1)

■ BAM Sentences (Continued)

◇ Output sentences (IEC61162-1)

ALC, ALF, and ARC

◇ Output interval

ALC: 30 seconds

ALF: Irregular output (Output immediately when an alert occurs or the content of the sentence is changed.)

ARC: Irregular output (Output immediately when an ACN sentence cannot be accepted.)

◇ Output sentence description

• ALC—Cyclic alert list

\$--ALC, xx, xx, xx, x.x, aaa, x.x, x.x, x.x,, aaa, x.x, x.x, x.x*hh<CR><LF>
1 2 3 4 5 6 7 8

1	Total number of sentences for this message (01 to 99)	5	Manufacturer mnemonic code (NULL)
2	Sentence number (01 to 99)	6	Alert identifier
3	Sequential message identifier (00 to 99)	7	Alert instance (1 to 999999)
4	Number of alert entries	8	Revision counter (1 to 99)

• **ALF—Alert sentence**

\$--ALF, x, x, x, hhmmss.ss, a, a, a, aaa, x.x, x.x, x.x, x, c---c*hh<CR><LF>
 1 2 3 4 5 6 7 8 9 10 11 12 13

1	Total number of ALF sentences for this message (1 to 2)	8	Manufacturer mnemonic code (NULL)
2	Sentence number (1 to 2)	9	Alert identifier
3	Sequential message identifier (0 to 9)	10	Alert instance (1 to 999999)
4	Time of last change (000000.00 to 235959.99, or NULL)	11	Revision counter (1 to 99)
5	Alert category (A=Category A, B*=Category B, C=Category C)	12	Escalation counter (0 to 9)
6	Alert priority (E=Emergency Alarm, A=Alarm, W*=Warning, C*=Caution)	13	Alert text (Two sentences are output for an alert. One is "Alert title," the other is "Alert description.")
7	Alert state (A=Active – unacknowledged, S=Active – silenced, N=Active – acknowledged or active, O=Active – responsibility transferred, U=Rectified – unacknowledged, V=Normal)		

* The transceiver can output.

• **ARC—Alert command refused**

\$--ARC, hhmmss.ss, aaa, x.x, x.x, c*hh<CR><LF>
 1 2 3 4 5

1	Release time of the Alert Command Refused (000000.00 to 235959.99, or NULL)	4	Alert Instance (1 to 999999)
2	Manufacture mnemonic code (NULL)	5	Refused alert command (A=Acknowledge, Q=Request/Repeat information, O=Responsibility transfer, S=Silence)
3	Alert Identifier		

14 DIGITAL INTERFACE (IEC61162-1)

■ Schematic diagram

◇ IEC61162-1/BAM In/Out lines

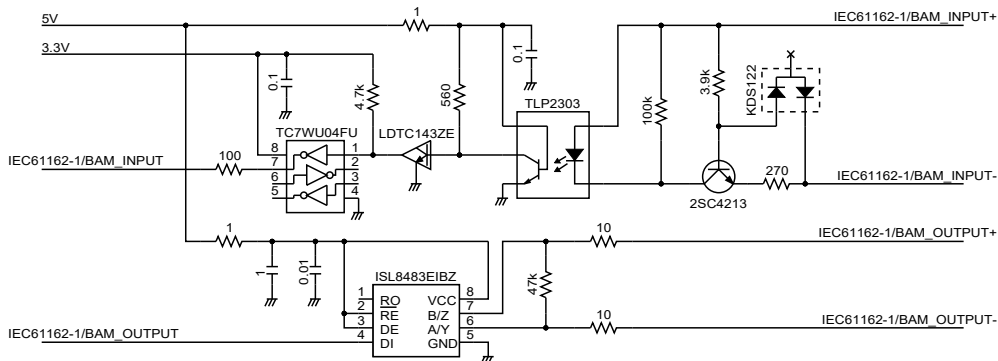

The input circuit is electrically isolated by the TPL2303.

■ Hardware version

The transceiver's hardware version is described on the serial number label, as shown to the right.

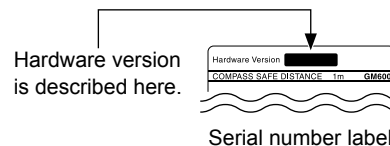

■ Software version

You can confirm the transceiver's software version in the Menu screen. See page 91 for details.

You can receive the following BAM alerts.

- See page 20 for details of the BAM function.

ID	3122	3122	3122
Priority	Warning	Warning	Warning
Category	B	B	B
Acknowledge	Yes	Yes	Yes
Responsibility transfer	Yes	Yes	Yes
Remove after rectified	–	–	–
Escalation properties	Repeated as a warning after 90 seconds.	Repeated as a warning after 90 seconds.	Repeated as a warning after 90 seconds.
Alert title	DISTRESS: RX	DISTRESS: RELAY	URGENCY: RX
Alert description	<ul style="list-style-type: none"> • Type of message • MMSI code • Latitude • Longitude • Channel for the Voice Communication 	<ul style="list-style-type: none"> • Type of message • MMSI code • Latitude • Longitude • Channel for the Voice Communication 	<ul style="list-style-type: none"> • Type of message • MMSI code • Channel for the Voice Communication
What to do	Confirm the received DSC call.	Confirm the received DSC call.	Confirm the received DSC call.
Reasons and conditions	<ul style="list-style-type: none"> • When the following DSC calls are received: <ul style="list-style-type: none"> - Distress Call - Distress ACK - Distress Cancel • The alert disappears when the message is read. 	<ul style="list-style-type: none"> • When the following DSC calls are received: <ul style="list-style-type: none"> - Distress Relay - Distress Relay ACK • The alert disappears when the message is read. 	<ul style="list-style-type: none"> • When the following DSC calls are received: <ul style="list-style-type: none"> - All Ships Call - Medical Transports - Ships and Aircraft - Geographic Area Call - Individual Call - Individual ACK - Group Call • The alert disappears when the message is read.

15 BAM ALERTS

ID	3122	3122	3123
Priority	Warning	Warning	Caution
Category	B	B	B
Acknowledge	Yes	Yes	–
Responsibility transfer	Yes	Yes	–
Remove after rectified	–	–	–
Escalation properties	Repeated as a warning after 90 seconds.	Repeated as a warning after 90 seconds.	–
Alert title	URGENCY: RX	URGENCY: RX	<ul style="list-style-type: none"> • SAFETY: COM • ROUTINE: COM
Alert description	<ul style="list-style-type: none"> • Type of message • MMSI code 	<ul style="list-style-type: none"> • Type of message • MMSI code • Latitude • Longitude 	<ul style="list-style-type: none"> • Type of message • MMSI code • Channel for the Voice Communication
What to do	Confirm the received DSC call.	Confirm the received DSC call.	Confirm the received DSC call.
Reasons and conditions	<ul style="list-style-type: none"> • When the following DSC calls are received: <ul style="list-style-type: none"> - Position Request - Polling Request - Polling Reply - Test Call - Test ACK • The alert disappears when the message is read. 	<ul style="list-style-type: none"> • When the following DSC calls are received: <ul style="list-style-type: none"> - Position Reply - Position Report - Position Report Request • The alert disappears when the message is read. 	<ul style="list-style-type: none"> • When the following DSC calls are received: <ul style="list-style-type: none"> - All Ships Call - Medical Transports - Ships and Aircraft - Geographic Area Call - Individual Call - Individual ACK - Group Call • The alert disappears when the message is read.

ID	3123	3123	3123
Priority	Caution	Caution	Caution
Category	B	B	B
Acknowledge	–	–	–
Responsibility transfer	–	–	–
Remove after rectified	–	–	–
Escalation properties	–	–	–
Alert title	<ul style="list-style-type: none"> • SAFETY: POS • ROUTINE: POS 	<ul style="list-style-type: none"> • SAFETY: POLL • ROUTINE: POLL 	<ul style="list-style-type: none"> • SAFETY: TEST • ROUTINE: TEST
Alert description	<ul style="list-style-type: none"> • Type of message • MMSI code 	<ul style="list-style-type: none"> • Type of message • MMSI code 	<ul style="list-style-type: none"> • Type of message • MMSI code
What to do	Confirm the received DSC call.	Confirm the received DSC call.	Confirm the received DSC call.
Reasons and conditions	<ul style="list-style-type: none"> • When the following DSC calls are received: <ul style="list-style-type: none"> - Position Request • The alert disappears when the message is read. 	<ul style="list-style-type: none"> • When the following DSC calls are received: <ul style="list-style-type: none"> - Polling Request - Polling Reply • The alert disappears when the message is read. 	<ul style="list-style-type: none"> • When the following DSC calls are received: <ul style="list-style-type: none"> - Test Call - Test ACK • The alert disappears when the message is read.

15 BAM ALERTS

ID	3123	3016	3013
Priority	Caution	Caution	Caution
Category	B	B	B
Acknowledge	–	–	–
Responsibility transfer	–	–	–
Remove after rectified	–	–	–
Escalation properties	–	–	–
Alert title	<ul style="list-style-type: none"> • SAFETY: POS • ROUTINE: POS 	SARPOSITION LOST	DOUBTFUL POS
Alert description	<ul style="list-style-type: none"> • Type of message • MMSI code • Latitude • Longitude 	<ul style="list-style-type: none"> • Manual entry required • When 4 hours have passed: 4hrs have elapsed. Manual entry required • When 23.5 hours have passed: Position deleted. Manual entry required 	<ul style="list-style-type: none"> • Update the position • When 23.5 hours have passed: Position deleted. Update the position
What to do	Confirm the received DSC call.	Manually update the position data.	Update the position data.
Reasons and conditions	<ul style="list-style-type: none"> • When the following DSC calls are received: <ul style="list-style-type: none"> - Position Reply - Position Report - Position Report Request • The alert disappears when the message is read. 	<ul style="list-style-type: none"> • When the position data has not been updated for 10 minutes (for 1 minute after turning ON the transceiver). • When the position data has not been updated for 4 hours. • After the position data has not been updated for 23.5 hours. • The alert disappears when the position data is updated or manually entered. 	<ul style="list-style-type: none"> • When the position data has not been manually updated for 4 hours. • After the manually entered position data has not been updated for 23.5 hours. • The alert disappears when the position data is updated or manually entered.

ID	3115	3079
Priority	Warning	Caution
Category	B	B
Acknowledge	Yes	–
Responsibility transfer	Yes	–
Remove after rectified	No	–
Escalation properties	Repeated as a warning after 90 seconds.	–
Alert title	IMPAIRED RADIO	OOW ATTENTION
Alert description	PLL is unlocked	DSC task is full
What to do	You cannot transmit and receive. Contact your dealer.	<ul style="list-style-type: none"> • Confirm the task. • Delete the task.
Reasons and conditions	<ul style="list-style-type: none"> • When the transceiver's Phase Lock Loop (PLL) is unlocked. • The alert disappears when the PLL is locked. 	<ul style="list-style-type: none"> • When the transceiver holds 7 DSC tasks (including the RT mode task). • The alert disappears when there are 6 or less tasks.

INDEX

A		D		Group ID entering		Non-Distress call	
Accessory		Dimensions (GM600/PS-310)	100	Individual acknowledgment		All Ships call	51
Accessory connectors set up ..	95	Discrete (Alarm Status)	80	ACK (Able)	65	Group call	52
Handset (HS-98)	98	Display		ACK (New CH)	66	Individual	
Speaker Microphone	5	Backlight	83	ACK (Unable)	66	acknowledgment	50
Supplied accessories	95	Mode	83	Individual ID deleting	30	Individual call	48
Alarm Status	79	Night Mode Time	84	Individual ID entering	29	Medical Transports call..	58
Antenna	94	Disposal	i	Position and time entry	31	Polling Request	
B		DSC Operation	29	Receiving	60	acknowledgment	55
Backlight function	17	Address ID	29	All Ships call	67	Position Request	
BAM		Distress call		Distress acknowledgment..	61	acknowledgment	54
Alerts	21	Call log	75	Distress Cancel call	62	Position Request call..	53
BAM List	24	Regular call	36	Distress Relay		Ships and Aircraft call..	59
Category	22	Relay call		acknowledgment	63	Test call	56
Function	22, 88	With Distress Call Log..	45	Distress Relay call	62	Test call	
Icon	23	With DROBOSE	42	Geographical Area call	68	acknowledgment	57
Priority	22	Resending	38	Group call	68	Dualwatch/Tri-watch	28
Software Key	25	Sending	35	Individual acknowledgment..	65	Dualwatch	28
Status	23	Simple call	35	Individual call	64	Tri-watch	28
Basic operation	13	DSC settings	77	Medical Transports call...	73	E	
C		Alarm Status	79	Polling Request call	71	Emergency	
Call log		Automatic		Position Report call	70	Using channel 16	ii
Received Call log	75	Acknowledgement	77	Position Request		Using digital selective calling	
Transmitted Call log	76	Auto Print	81	acknowledgment	70	(Ch 70)	ii
Channel		Channel 70 Squelch level..	81	Position Request Call	69	Explicit definitions	i
Call channel selecting	13	CH Auto Switch	78	Ships and Aircraft call	74	F	
Call channel setting	14	Medical Transports	78	Test acknowledgment	72	Favorite channels	27
Channel 16 selecting	13	Self Check Test	81	Test call	72	Clearing	27
Channel area	7	Ships and Aircraft	78	Sending		Selecting	27
Channel list	103	DSC Task mode	33	Distress call		Setting	27
Channel name entry	18	Activating the held DSC		Distress		Front panel	2
Cleaning	94	task	33	acknowledgment	40	Function display (Main screen)..	6
Connections	92	Devices List	34	Distress Cancel call	39	Channel area	7
Power source connection	96	Holding a DSC task	33	Distress Relay		Information area	7
		Task List	34	acknowledgment	47	Position and Time area	8
		Group ID deleting	30	Distress Relay call	42		

Software Key area.....	6				
Status area.....	6				
Task area.....	6				
Fuse replacement.....	94				
H					
Handset (HS-98).....	98				
Connection.....	98				
I					
Icon description.....	iv				
Inactivity Timer					
Distress Related.....	87				
DSC Related.....	87				
Not DSC Related.....	86				
RT Related.....	87				
Individual call					
Acknowledgment.....	65				
Receiving.....	64				
Sending.....	48				
Information area.....	7				
In/Out lines' specifications (IEC61162-1).....	93				
Installation					
Installation note.....	ii				
Mounting the transceiver.....	97				
K					
Key Assignment					
Set Default.....	85				
Softkey 1 ~ 12.....	85				
L					
License (Operator).....	1				
License (Ship station).....	1				
M					
Maintenance.....	94				
Antenna.....	94				
Cleaning.....	94				
Fuse replacement.....	94				
Software maintenance.....	94				
Menu.....	82				
Compose Distress.....	36				
Compose DROBOSE.....	42				
Compose Non-Distress					
Group call.....	52				
Individual call.....	48				
Medical Transports call....	58				
Position Request call.....	53				
Ships and Aircraft call.....	59				
Test call.....	56				
Configuration settings.....	83				
BAM.....	88				
Display.....	83				
Inactivity Timer.....	86				
Internal Speaker.....	89				
Key Assignment.....	85				
Key Beep.....	85				
MIC Type.....	89				
Position Data Output.....	88				
UTC Offset.....	86				
Construction.....	10				
DSC Log.....	75				
DSC settings.....	77				
GPS Information.....	83				
Menu item selecting.....	12				
Menu screen.....	10				
Radio Information.....	91				
Radio settings.....	90				
Call Channel.....	90				
Channel Display.....	91				
Dual/Tri-Watch.....	90				
FAV on MIC.....	91				
Favorite Channel.....	91				
Scan Timer.....	90				
Scan Type.....	90				
Microphone Lock function.....	17				
MMSI code entry.....	9				
Mounting the transceiver.....	97				
N					
Normal scan.....	26				
O					
Operating rules.....	1				
Options.....	100				
P					
Panel description.....	2				
Position and Time area.....	8				
Position and time entry.....	31				
Position area.....	8				
Power source connections.....	96				
Precautions.....	iii				
Preparation (MMSI code entry) ..	9				
Priority scan.....	26				
PS-310.....	96				
Dimensions.....	100				
Power source connection.....	96				
R					
Radio Telephone (RT) mode ...	14				
Received Call log.....	75				
Distress message.....	75				
Other messages.....	75				
Receiving.....	15				
Routine (Alarm Status).....	79				
S					
Safety (Alarm Status).....	79				
Scan operation					
Normal scan.....	26				
Priority scan.....	26				
Scan type.....	26				
Starting.....	27				
Self-Terminate (Alarm Status) ..	80				
Software Key.....	5				
Software Key function selecting..	5				
Software Key functions in the Received Call Log screen ...	75				
Software Key functions in the Transmitted Call Log screen ..	76				
Software maintenance.....	94				
Speaker Microphone.....	5				
Specifications.....	99				
Status area.....	6				
T					
Task area.....	6				
Time area.....	8				
Time entry.....	31				
Time-out Timer (TOT) function ..	16				
Transmitted Call log.....	76				
Transmitting.....	15				
Troubleshooting.....	101				
W					
Warning (Alarm Status).....	79				

How the World Communicates

A7239D-7EU
Printed in Japan
© 2022 Icom Inc.

Sep. 2022

Icom Inc.
1-1-32 Kamiminami, Hirano-ku, Osaka 547-0003, Japan