



INSTRUCTION MANUAL

HF/50 MHz
ALL MODE TRANSCEIVER
IC-756PROIII



IMPORTANT

READ THIS INSTRUCTION MANUAL CAREFULLY before attempting to operate the transceiver.

SAVE THIS INSTRUCTION MANUAL. This manual contains important safety and operating instructions for the IC-756PROIII.

FOREWORD

We understand that you have a choice of many different radios in the market place. We would like to take a couple of moments of your time to thank you for making your IC-756PROIII your radio of choice, and hope you agree with Icom's philosophy of "technology first." Many hours of research and development went into the design of your IC-756PROIII.

◇ FEATURES

- *+30 dBm class IP3 (at 14 MHz band) and further improved 3rd order IMD characteristics*
- *Real time spectrum scope with mini-scope function*
- *Baudot RTTY demodulator and RTTY transmit message memory*
- *Selectable SSB transmission passband width (Each for Higher and lower pass frequency)*
- *Digital IF filter allows you to select 51 types of filter shapes while receiving a station*

Spurious may be received near the following frequencies. These are made in the internal circuit and does not indicate a transceiver malfunction:

6.144 MHz, 8.000 MHz,
12.288 MHz, 12.890 MHz (when spectrum scope is ON),
18.433 MHz, 24.573 MHz, 52 MHz

EXPLICIT DEFINITIONS

WORD	DEFINITION
⚠ WARNING	Personal injury, fire hazard or electric shock may occur.
CAUTION	Equipment damage may occur.
NOTE	If disregarded, inconvenience only. No risk or personal injury, fire or electric shock.

SUPPLIED ACCESSORIES

The transceiver comes with the following accessories.

	Qty.
① DC power cable (OPC-025D)	1
② Hand microphone (HM-36)	1
③ Spare fuses (FGB 30 A)	2
④ Spare fuse (FGB 5 A)	1
⑤ CW keyer plug (AP-330)	1

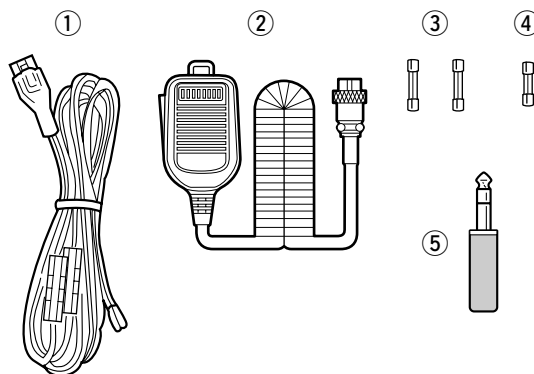

Icom, Icom Inc. and the  are registered trademarks of Icom Incorporated (Japan) in the United States, the United Kingdom, Germany, France, Spain, Russia and/or other countries.

PRECAUTIONS

⚠ WARNING RF EXPOSURE! This device emits Radio Frequency (RF) energy. Extreme caution should be observed when operating this device. If you have any questions regarding RF exposure and safety standards please refer to the Federal Communications Commission Office of Engineering and Technology's report on Evaluating Compliance with FCC Guidelines for Human Radio Frequency Electromagnetic Fields (OET Bulletin 65).

⚠ WARNING HIGH VOLTAGE! NEVER attach an antenna or internal antenna connector during transmission. This may result in an electrical shock or burn.

⚠ WARNING! NEVER operate the transceiver with a headset or other audio accessories at high volume levels. Hearing experts advise against continuous high volume operation. If you experience a ringing in your ears, reduce the volume or discontinue use.

⚠ CAUTION! NEVER change the internal settings of the transceiver. This result in reduced transceiver performance and/or damage to the transceiver.

In particular, incorrect settings for transmitter circuits, such as output power, idling current, etc., might damage the expensive final devices.

The transceiver warranty does not cover any problems caused by unauthorized internal adjustment.

⚠ NEVER apply AC to the [DC13.8V] jack on the transceiver rear panel. This could cause a fire or ruin the transceiver.

⚠ NEVER apply more than 16 V DC, such as a 24 V battery, to the [DC13.8V] jack on the transceiver rear panel. This could cause a fire or ruin the transceiver.

⚠ NEVER let metal, wire or other objects touch any internal part or connectors on the rear panel of the transceiver. This may result in an electric shock.

⚠ NEVER expose the transceiver to rain, snow or any liquids.

⚠ NEVER installing the transceiver in a place without adequate ventilation. Heat dissipation may be affected, and the transceiver may be damaged.

⚠ NEVER operate or touch the transceiver with wet hands. This may result in an electric shock or damage to the transceiver.

AVOID using or placing the transceiver in areas with temperatures below -10°C ($+14^{\circ}\text{F}$) or above $+50^{\circ}\text{C}$ ($+122^{\circ}\text{F}$). Be aware that temperatures on a vehicle's dashboard can exceed 80°C ($+176^{\circ}\text{F}$), resulting in permanent damage to the transceiver if left there for extended periods.

AVOID placing the transceiver in excessively dusty environments or in direct sunlight.

AVOID placing the transceiver against walls or putting anything on top of the transceiver. This will obstruct heat dissipation.

Place unit in a secure place to avoid inadvertent use by children.

During mobile operation, **DO NOT** operate the transceiver without running the vehicle's engine. When transceiver power is ON and your vehicle's engine is OFF, the vehicle's battery will soon become exhausted.

Make sure the transceiver power is OFF before starting the vehicle. This will avoid possible damage to the transceiver by ignition voltage spikes.

During maritime mobile operation, keep the transceiver and microphone as far away as possible from the magnetic navigation compass to prevent erroneous indications.

BE CAREFUL! The heatsink will become hot when operating the transceiver continuously for long periods.

BE CAREFUL! If a linear amplifier is connected, set the transceiver's RF output power to less than the linear amplifier's maximum input level, otherwise, the linear amplifier will be damaged.

The LCD display may have cosmetic imperfections that appear as small or dark spots. This is not a malfunction or defect, but a normal characteristic of LCD displays.

Use Icom microphones only (supplied or optional). Other manufacturer's microphones have different pin assignments, and connection to the IC-756PROIII may damage the transceiver.

For U.S.A. only

CAUTION: Changes or modifications to this device, not expressly approved by Icom Inc., could void your authority to operate this device under FCC regulations.

TABLE OF CONTENTS

IMPORTANT	i
FOREWORD	i
EXPLICIT DEFINITIONS	i
SUPPLIED ACCESSORIES	i
PRECAUTIONS	ii
TABLE OF CONTENTS	iii
1 PANEL DESCRIPTION	1–12
■ Front panel	1
■ LCD display	9
■ Screen menu arrangement	10
■ Rear panel	11
■ Microphone (HM-36)	12
2 INSTALLATION AND CONNECTIONS	13–20
■ Unpacking	13
■ Selecting a location	13
■ Grounding	13
■ Antenna connection	13
■ Required connections	14
■ Advanced connections	15
■ Power supply connections	16
■ Linear amplifier connections	17
■ External antenna tuner connections	18
■ Transverter jack information	18
■ Microphone connector information	18
■ FSK and AFSK (SSTV) connections	19
■ Accessory connector information	20
3 BASIC OPERATION	21–32
■ When first applying power (CPU resetting)	21
■ Initial settings	21
■ VFO description	22
■ Selecting VFO/memory mode	23
■ Main/Sub band selection	23
■ Selecting an operating band	24
◇ Using the band stacking registers	24
■ Frequency setting	25
◇ Tuning with the tuning dial	25
◇ Direct frequency entry with the keypad	25
◇ Quick tuning step	26
◇ Selecting “kHz” step	26
◇ Selecting 1 Hz step	27
◇ 1/4 tuning function (SSB data/CW/RTTY only)	27
◇ Auto tuning step function	28
◇ Band edge warning beep	28
■ Operating mode selection	29
■ Volume setting	29
■ Squelch and receive (RF) sensitivity	30
■ Meter function	31
■ SWR reading	31
■ Basic transmit operation	32
◇ Transmitting	32
◇ Microphone gain adjustment	32
4 RECEIVE AND TRANSMIT	33–54
■ Operating SSB	33
◇ Convenient functions for receive	33
◇ Convenient functions for transmit	34
◇ About 5 MHz band operation (USA version only)	34
■ Operating CW	35
◇ Convenient functions for receive	35
◇ Convenient functions for transmit	36
◇ About CW reverse mode	36
◇ CW side tone function	36
◇ About CW pitch control	37
■ Electronic CW keyer	38
◇ Memory keyer send screen	39
◇ Editing a memory keyer	40
◇ Contest number set mode	41
◇ Keyer set mode	42
■ Operating RTTY (FSK)	44
◇ Convenient functions for receive	44
◇ About RTTY reverse mode	45
◇ RTTY filter/Twin peak filter	45
◇ Functions for the RTTY decoder indication	46
◇ Setting the decoder threshold level	46
◇ RTTY memory transmission	47
◇ RTTY tuning meter	47
◇ Editing RTTY memory	48
◇ RTTY decoder set mode	49
■ Operating AM	50
◇ Convenient functions for receive	50
◇ Convenient functions for transmit	50
■ Operating FM	51
◇ Convenient functions for receive	51
◇ Convenient functions for transmit	51
■ Repeater operation	52
◇ Setting the repeater tone	52
■ Tone squelch operation	53
■ Data mode (SSTV/PSK31) operation	54
5 FUNCTION FOR RECEIVE	55–65
■ Spectrum scope screen	55
◇ Mini scope screen	55
◇ Scope set mode	56
■ Preamplifier	57
■ Attenuator	57
■ RIT function	58
■ AGC function	59
■ Twin PBT operation	60
■ IF filter selection	61
■ DSP filter shape	62
■ Dualwatch operation	63
■ Noise blanker	64
■ Notch function	64
■ Noise reduction	65
■ Dial lock function	65

TABLE OF CONTENTS

6 FUNCTION FOR TRANSMIT	66–72	12 SET MODE	94–104	1
■ VOX function	66	■ Set mode description	94	2
◇ Using the VOX function	66	■ Level set mode	95	3
◇ Adjusting the VOX function	66	■ Display set mode	97	4
■ Break-in function	67	■ DSP filter set mode	99	5
◇ Semi break-in operation	67	■ Miscellaneous (others) set mode	99	6
◇ Full break-in operation	67	13 OPTION INSTALLATION	105	7
■ Transmit filter width setting (SSB only)	68	■ Opening the transceiver's case	105	8
■ Speech compressor	68	■ UT-102 VOICE SYNTHESIZER UNIT	105	9
■ Δ TX function	69	14 INTERNAL VIEWS	106	10
■ Monitor function	70	15 MAINTENANCE	107–109	11
■ Split frequency operation	71	■ Troubleshooting	107	12
■ Quick split function	72	■ Fuse replacement	108	13
7 VOICE RECORDER FUNCTIONS	73–76	■ Clock backup battery replacement	108	14
■ Digital voice recorder	73	■ Tuning dial brake adjustment	109	15
8 MEMORY OPERATION	77–82	■ Frequency calibration (approximate)	109	16
■ Memory channels	77	16 CONTROL COMMAND	110–114	17
■ Memory channel selection	77	■ Remote jack (CI-V) information	110	18
■ Memory channel screen	78	17 SPECIFICATIONS	115	19
■ Memory channel programming	79	18 OPTIONS	116	
■ Frequency transferring	80	19 ABOUT CE	117	
■ Memory names	81			
■ Memory clearing	81			
■ Memo pads	82			
9 SCANS	83–87			
■ Scan types	83			
■ Preparation	83			
■ Programmed scan operation	84			
■ Δ F scan operation	84			
■ Fine programmed scan/ fine Δ F scan	85			
■ Memory scan operation	85			
■ Select memory scan operation	86			
■ Setting select memory channels	86			
■ Scan set mode	87			
■ Tone scan	87			
10 ANTENNA TUNER OPERATION	88–90			
■ Automatic antenna selection	88			
■ Antenna tuner operation	89			
■ Optional external tuner operation	90			
11 CLOCK AND TIMERS	91–93			
■ Time set mode	91			
◇ Setting the current time	92			
◇ Clock2 function activity	92			
◇ Clock2 offset setting	92			
◇ Timer function activity	92			
◇ Setting power-on time	93			
◇ Setting power-off period	93			
◇ Timer operation	93			

1
2
3
4
5
6
7
8
9
10
11
12
13
14
15
16
17
18
19

■ Front panel

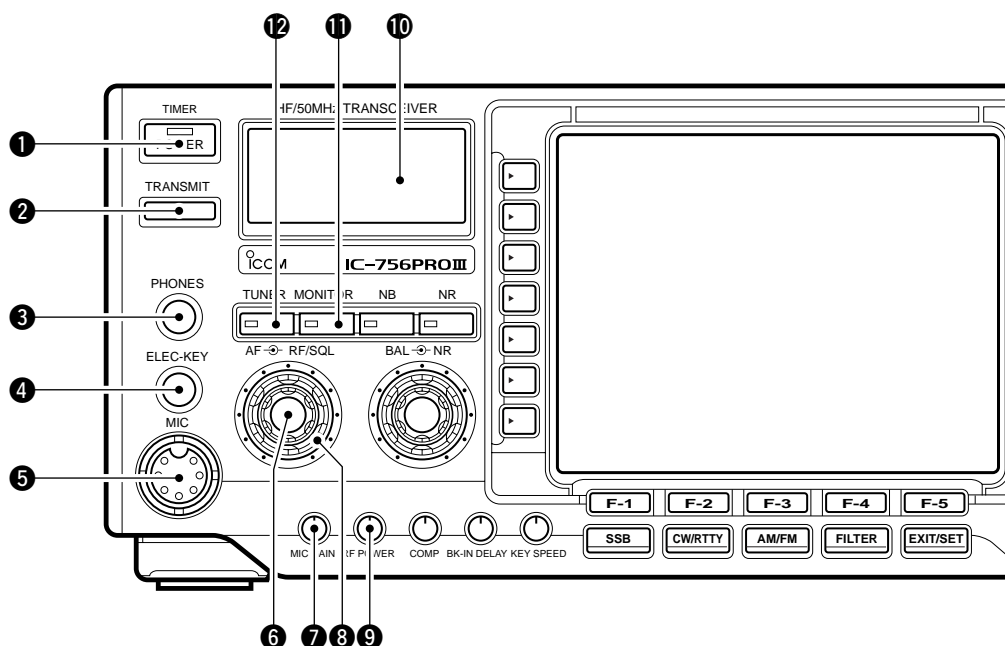

1 POWER SWITCH [POWER•TIMER]

- While transceiver's power is OFF:
 - Push to turn power ON.
 - Turn the optional DC power supply ON in advance.
 - A/D converter calibration of the DSP unit starts and it takes approx. 10 sec.
 - While transceiver's power is ON:
 - ➔ Push momentarily to toggle the timer function ON and OFF. (p. 93)
 - The [TIMER] indicator in this switch lights while the timer function is ON.
 - ➔ Push for 1 sec. to turn power OFF.

2 TRANSMIT SWITCH [TRANSMIT]

- Selects transmitting or receiving.
 - The [TX] indicator lights red while transmitting and the [RX] indicator lights green when the squelch is open.

3 HEADPHONE JACK [PHONES]

- Accepts headphones.
 - Output power: 5 mW with an 8 Ω load.
 - When headphones are connected, the internal speaker or connected external speaker does not function.

4 ELECTRONIC KEYSER JACK [ELEC-KEY]

- Accepts a paddle to activate the internal electronic keyer for CW operation. (p. 38)
 - Selection between the internal electronic keyer, bug-key and straight key operation can be made in keyer set mode. (p. 43)
 - A straight key jack is separately available on the rear panel. See [KEY] on p. 11.
 - Keyer polarity (dot and dash) can be reversed in keyer set mode. (p. 43)
 - 4-channel memory keyer is available for your convenience. (p. 40)

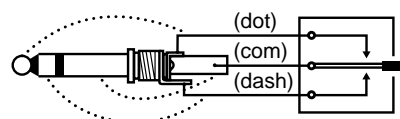

5 MICROPHONE CONNECTOR [MIC]

- Accepts the supplied or optional microphone.
 - See p. 116 for appropriate microphones.
 - See p. 18 for microphone connector information.

6 AF CONTROL [AF] (inner control)

- Varies the audio output level from the speaker.

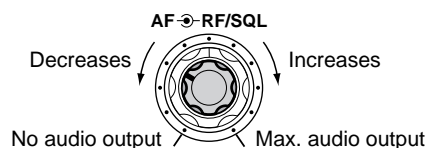

7 MIC GAIN CONTROL [MIC GAIN]

- Adjusts microphone input gain.
 - The transmit audio tone in SSB mode can be adjusted in set mode. (p. 95)

✓ How to set the microphone gain.

Set the [MIC] control so that the ALC meter sometimes swings during normal voice level transmission in SSB mode.

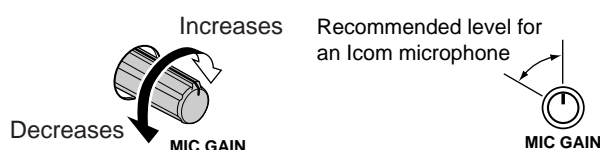

8 RF GAIN CONTROL/SQUELCH CONTROL [RF/SQL] (outer control)

Adjusts the RF gain and squelch threshold level. The squelch removes noise output from the speaker (closed condition) when no signal is received.

- The squelch is particularly effective for FM. It is also available for other modes.
- 12 to 1 o'clock position is recommended for any setting of the [RF/SQL] control.
- The control can be set as 'Auto' (RF gain control in SSB, CW and RTTY; squelch control in AM and FM) or squelch control (RF gain is fixed at maximum) in set mode as follows. (p. 99)

MODE	SET MODE SETTING		
	AUTO	SQL	RF GAIN + SQL
SSB, CW RTTY	RF GAIN	SQL	RF GAIN + SQL
AM, FM	SQL	SQL	RF GAIN + SQL

•When setting as RF gain/squelch control

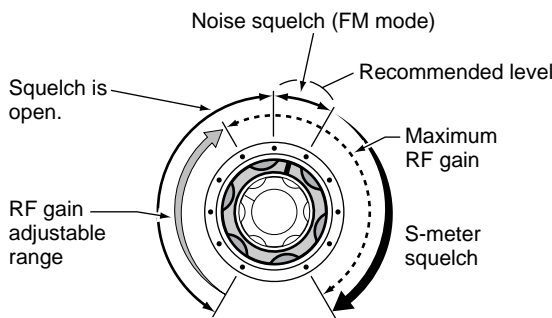

•When functioning as RF gain control

(Squelch is fixed open; SSB, CW, RTTY only)

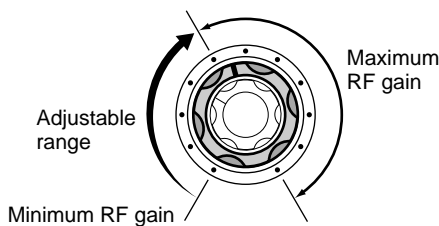

•When functioning as squelch control

(RF gain is fixed at maximum.)

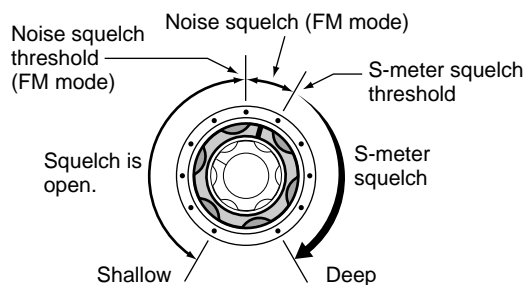

While rotating the RF gain control, noise may be heard. This comes from the DSP unit and does not indicate an equipment malfunction.

9 RF POWER CONTROL [RF POWER]

Continuously varies the RF output power from minimum (5 W*) to maximum (100 W*).

* AM mode: 5 W to 40 W

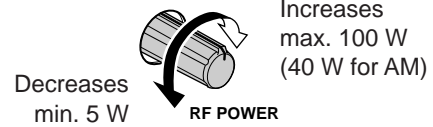

10 S/RF METER (p. 31)

Shows the signal strength while receiving. Shows the relative output power, SWR, ALC or compression levels while transmitting.

11 MONITOR SWITCH [MONITOR] (p. 70)

Monitors your transmitted IF signal.

- The CW side tone functions regardless of the [MONITOR] switch setting in CW mode.
- The [MONITOR] indicator in this switch lights green when the function is activated.

12 ANTENNA TUNER SWITCH [TUNER] (p. 89)

Turns the internal antenna tuner ON and OFF (bypass) when pushed momentarily.

Tunes the antenna manually when pushed for 1 sec.

- The [TUNER] indicator in this switch lights red when the function is activated or blinks during manual tuning.
- When the tuner cannot tune the antenna, the tuning circuit is bypassed automatically after 20 sec.

■ Front panel (continued)

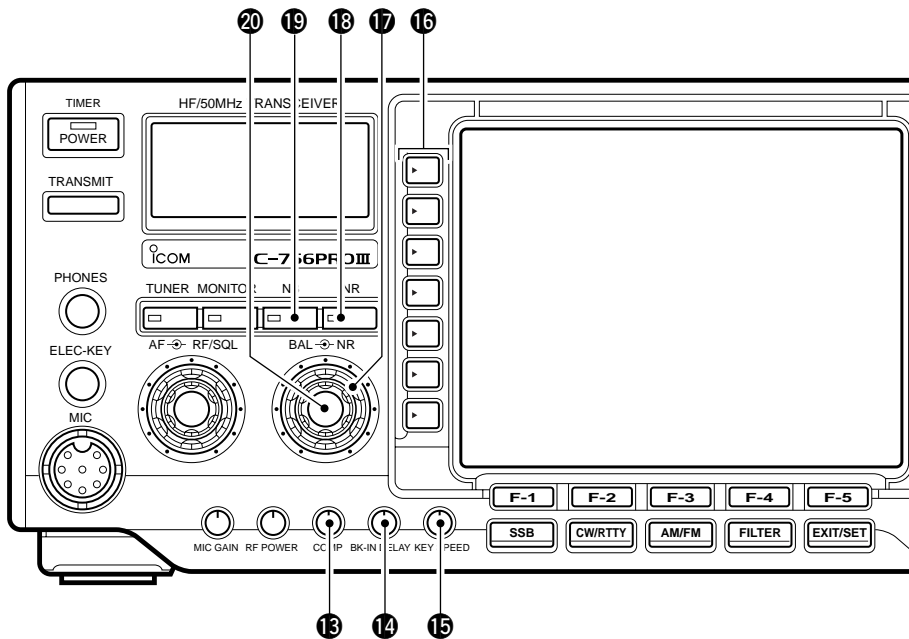

13 COMPRESSION LEVEL CONTROL [COMP]
(p. 68)
Adjusts the speech compression level in SSB.

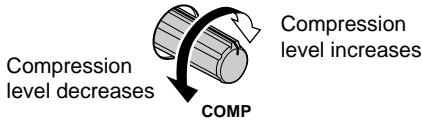

14 SEMI BREAK-IN DELAY CONTROL [BK-IN DELAY]
Adjusts the transmit-to-receive switching delay time for CW semi break-in operation.



15 ELECTRONIC CW KEYSER SPEED CONTROL [KEY SPEED] (p. 35)
Adjusts the internal electronic CW keyer's speed.
• 6 wpm (min.) to 60 wpm (max.) can be set.



16 MULTI-FUNCTION SWITCHES
Push to select the functions indicated in the LCD display to the right of these switches.
• Functions vary depending on the operating condition.



- ➔ Selects the antenna connector between ANT1 and ANT2 when pushed. (p. 88)
- ➔ Turns the [RX ANT] (receive antenna) ON and OFF when pushed for 1 sec.
 - When the receive antenna is activated, the antenna which is connected to the [ANT1] or [ANT2] is used for transmission only.

When a transverter is in use, this [ANT] does not function and 'XVERT' appears.



- ➔ Selects RF power (P_o), SWR, ALC or COMP metering during transmit. (p. 31)
- ➔ Switches the multi-function digital meter ON and OFF when pushed for 1 sec.



- ➔ Selects one of 2 receive RF preamps or bypasses them. (p. 57)
 - "P. AMP1" activates 10 dB preamp.
 - "P. AMP2" activates 16 dB high-gain preamp.

✓ **What is the preamp?**

The preamp amplifies received signals in the front end circuit to improve the S/N ratio and increase the sensitivity. Select "P. AMP1" or "P. AMP2" when receiving weak signals.



- ➔ Selects 6 dB, 12 dB or 18 dB attenuator, or bypasses them. (p. 57)

✓ **What is the attenuator?**

The attenuator prevents a desired signal from distorting when very strong signals are near the desired frequency, or when very strong electric fields, such as from a broadcasting station, are near your location.



- ➔ Activates or selects fast, middle or slow AGC time constant when pushed. (p. 59)
 - “FAST” is only available for FM mode.
- ➔ Enters the AGC set mode when pushed for 1 sec. (p. 59)

AGC time constant can be set between 0.1 to 8.0 sec. (depends on mode), or turned OFF. While “OFF” is selected, the S-meter does not function.

✓ What is the AGC?

The AGC function controls receiver gain to produce a constant audio output level, even when the received signal strength is varied by fading, etc. Select “FAST” for tuning and select “MID” or “SLOW” depending on the receiving condition.



- ➔ Turns the VOX function ON and OFF when pushed in a phone mode (SSB, AM or FM mode). (p. 66)
- ➔ Enters the VOX set mode when pushed for 1 sec. in a phone mode. (p. 66)

✓ What is the VOX function?

The VOX function (voice operated transmission) starts transmission without pushing the transmit switch or PTT switch when you speak into the microphone; then, automatically returns to receive when you stop speaking.



- ➔ Selects semi break-in, full break-in operation, or turns the break-in operation OFF when pushed in CW mode. (p. 67)

✓ What is the break-in function?

The break-in function switches transmit and receive with CW keying. Full break-in function (QSK) can monitor the receive signal during keying.



- ➔ Turns the RTTY filter ON and OFF in RTTY mode. (p. 45)
 - When the RTTY filter is turned ON, [TWIN PBT] functions as the IF shift control.
- ➔ Enters the RTTY filter set mode when pushed for 1 sec. in RTTY mode. (p. 45)

✓ What is the IF shift?

The IF shift function electronically changes the center of the IF (Intermediate Frequency) passband frequency to reject interference. Only the inner control of [TWIN PBT] can be used for the IF shift control.



- ➔ Turns the speech compressor ON and OFF in SSB mode. (p. 68)
- ➔ Switches the narrow, middle or wide transmit filter when pushed for 1 sec.

✓ What is the speech compressor?

The speech compressor compresses the transmitter audio input to increase the average audio output level. Therefore, talk power is increased. This function is effective for long distance communication or when propagation conditions are poor.



- ➔ Turns the 1/4 function ON and OFF in SSB data, CW and RTTY modes. (p. 27)
 - 1/4 function sets dial rotation to 1/4 of normal for fine tuning.



- ➔ Switches the tone encoder, tone squelch function and no tone operation when pushed in FM mode. (pgs. 52, 53)
- ➔ Enters the tone set mode when pushed for 1 sec. in FM mode. (pgs. 52, 53)

17 NOISE REDUCTION LEVEL CONTROL [NR]

(outer control; p. 65)
Adjusts the noise reduction level when the noise reduction is in use. Set for maximum readability.
• To activate this control, turn the noise reduction ON in advance (18).

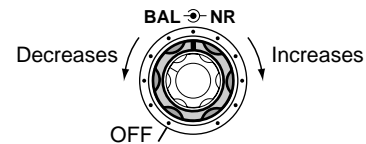

18 NOISE REDUCTION SWITCH [NR] (p. 65)

Push to switch the noise reduction ON and OFF.
• The [NR] indicator in this switch lights green when the function is activated.

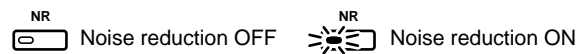

19 NOISE BLANKER SWITCH [NB] (p. 64)

- ➔ Switches the noise blanker ON and OFF when pushed. The noise blanker reduces pulse-type noise such as that generated by automobile ignition systems. This function cannot be used for FM mode, or non-pulse-type noise.
 - The [NB] indicator in this switch lights green when the function is activated.

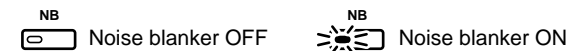

- ➔ Enters the noise blanker level set mode when pushed for 1 sec.

20 BALANCE CONTROL [BAL] (inner control; p. 63)

Adjusts the audio output balance between main and sub readout frequencies while in dualwatch.

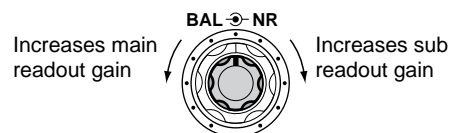

■ Front panel (continued)

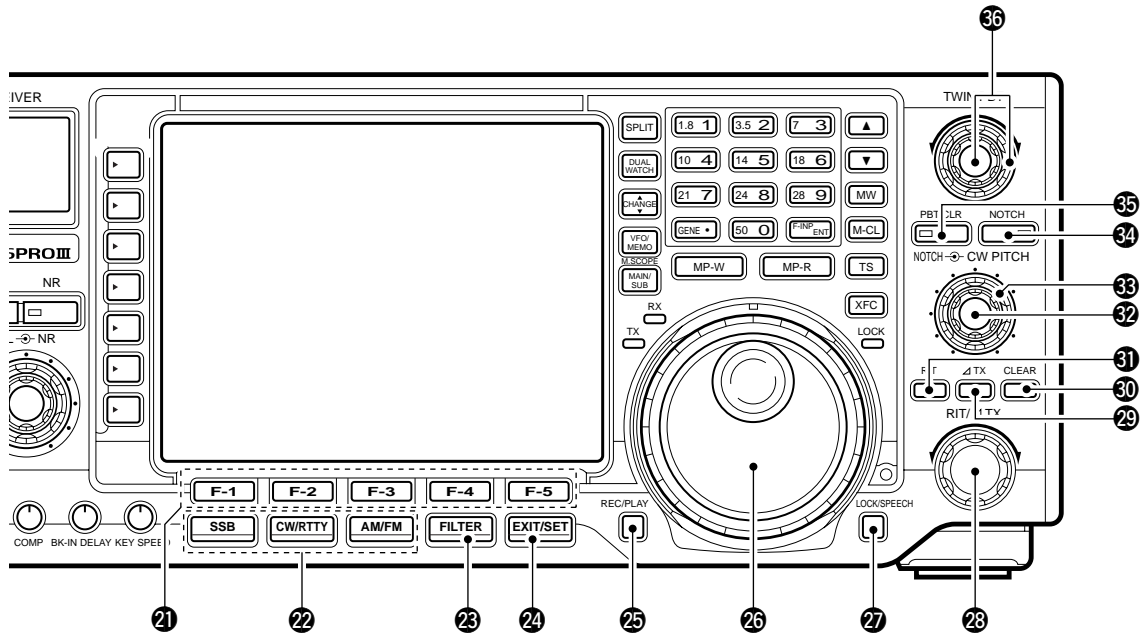

21 LCD FUNCTION SWITCHES [F-1]–[F-5]

Push to select the function indicated in the LCD display above these switches.
 • Functions vary depending on the operating condition.

22 MODE SWITCHES

Selects the desired mode. (p. 29)
 • Announces the selected mode when an optional UT-102 is installed. (pgs. 102, 105)

SSB ➔ Selects USB and LSB mode alternately.
 ➔ Selects SSB data mode (USB-D, LSB-D) when pushed for 1 sec. in SSB mode.

CW/RTTY ➔ Selects CW and RTTY mode alternately.
 ➔ Switches CW and CW-R (CW reverse) mode when pushed for 1 sec. in CW mode.
 ➔ Switches RTTY and RTTY-R (RTTY reverse) mode when pushed for 1 sec. in RTTY mode.

AM/FM ➔ Selects AM and FM mode alternately.
 ➔ Selects AM/FM data mode (AM-D, FM-D) when pushed for 1 sec. in AM or FM mode.

23 FILTER SWITCH [FILTER] (p. 61)

➔ Push to select one of 3 IF filter settings.
 ➔ Push for 1 sec. to enter the filter set mode.

24 EXIT/SET SWITCH [EXIT/SET]

➔ Push to exit from a set mode, etc.
 ➔ Push for 1 sec. to enter the set mode screen. (p. 94)

25 REC/PLAY SWITCH [REC/PLAY] (p. 73)

➔ Push momentarily to playback the recorded contents in the channel R4 of the voice memory.
 ➔ Push for 1 sec. to record the receiving signal contents into the channel R4 (max. 15 sec.) of the voice memory.

26 TUNING DIAL (p. 25)

Changes the displayed frequency, selects set mode settings, etc.

27 LOCK/SPEECH SWITCH [LOCK/SPEECH]

➔ Push momentarily to toggle the dial lock function ON and OFF. (p. 65)
 ➔ Push for 1 sec. to announce the S-meter indication and the selected readout frequency when an optional UT-102 is installed. (p. 105)

28 RIT/ΔTX CONTROL [RIT/ΔTX] (pgs. 58, 69)

Shifts the receive and/or transmit frequency without changing the transmit and/or receive frequency while the RIT and/or ΔTX functions are ON.
 • Rotate the control clockwise to increase the frequency, or rotate the control counterclockwise to decrease the frequency.
 • The shift frequency range is ±9.999 kHz in 1 Hz steps (or ±9.99 kHz in 10 Hz steps).



29 ΔTX SWITCH [ΔTX] (p. 69)

- ➔ Turns the ΔTX function ON and OFF when pushed.
 - Use the [RIT/ΔTX] control to vary the ΔTX frequency.
- ➔ Adds the ΔTX shift frequency to the operating frequency when pushed for 1 sec.

✓ What is the ΔTX function?

The ΔTX shifts the transmit frequency without shifting the receive frequency. This is useful for simple split frequency operation in CW, etc.

30 CLEAR SWITCH [CLEAR] (pgs. 58, 69)

- Clears the RIT/ΔTX shift frequency when pushed for 1 sec. (default).
 - The response time (for 1 sec. or momentarily) can be selected on the quick RIT/ΔTX clear setting (p. 103).

31 RIT SWITCH [RIT] (p. 58)

- ➔ Turns the RIT function ON and OFF when pushed.
 - Use the [RIT/ΔTX] control to vary the RIT frequency.
- ➔ Adds the RIT shift frequency to the operating frequency when pushed for 1 sec.

✓ What is the RIT function?

The RIT (Receiver Incremental Tuning) shifts the receive frequency without shifting the transmit frequency.

This is useful for fine tuning stations calling you on an off-frequency or when you prefer to listen to slightly different-sounding voice characteristics, etc.

32 MANUAL NOTCH FILTER CONTROL [NOTCH]

- (inner control; p. 64)
- Varies the peak frequency of the manual notch filter to pick out a receive signal from interference while the manual notch function is ON.
- Notch filter center frequency:
 - SSB : 0 Hz to 5100 Hz
 - CW : CW pitch freq. -900 Hz to CW pitch freq. +4200 Hz
 - AM : -5100 Hz to 5100 Hz

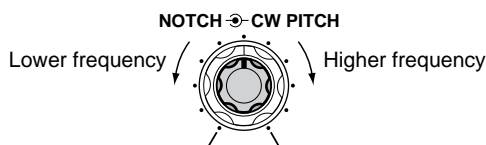

33 CW PITCH CONTROL [CW PITCH]

- (outer control; p. 37)
- Shifts the received CW audio pitch and monitored CW audio pitch without changing the operating frequency.

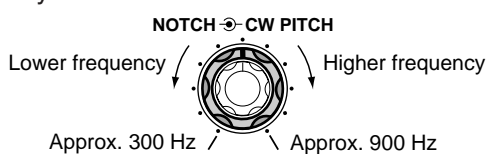

34 NOTCH SWITCH [NOTCH] (p. 64)

- ➔ Switches the notch function between auto, manual and OFF in SSB and AM modes.
- ➔ Turns the manual notch function ON and OFF when pushed in CW mode.
- ➔ Turns the auto notch function ON and OFF when pushed in FM mode.
 - “AN” appears on the display when auto notch is in use.
 - “MN” appears on the display when manual notch is in use.
 - The [NOTCH] indicator in this switch lights green when the function is activated.



✓ What is the notch function?

The notch function eliminates unwanted CW or AM carrier tones while preserving the desired signal’s audio response. The filtering frequency is adjusted to effectively eliminate unwanted tones via the DSP circuit.

35 PBT CLEAR SWITCH [PBT CLR] (p. 60)

- Clears the PBT settings when pushed for 1 sec.
 - The [PBT CLR] indicator in this switch lights green when PBT is in use.

36 PASSBAND TUNING CONTROLS [TWIN PBT]

- Adjust the receiver’s “passband width” of the DSP filter. (p. 60)
 - Passband width and shift frequency are displayed in the LCD.
 - Push [PBT CLR] for 1 sec. to clear the settings when not in use.
 - Variable range is set to half of the IF filter passband width. 25 Hz steps and 50 Hz steps are available.
 - These controls function as an IF shift control while in AM mode and when the RTTY filter is turned ON. Only the inner control may function in this case.

✓ What is the PBT control?

General PBT function electronically narrows the IF passband width to reject interference. This transceiver uses the DSP circuit for the PBT function.

TWIN PBT

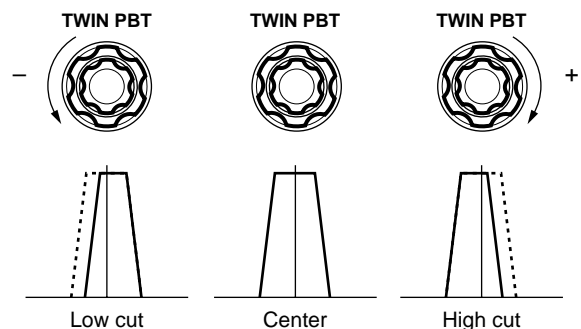
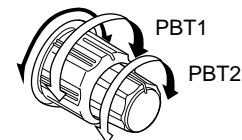

■ Front panel (continued)

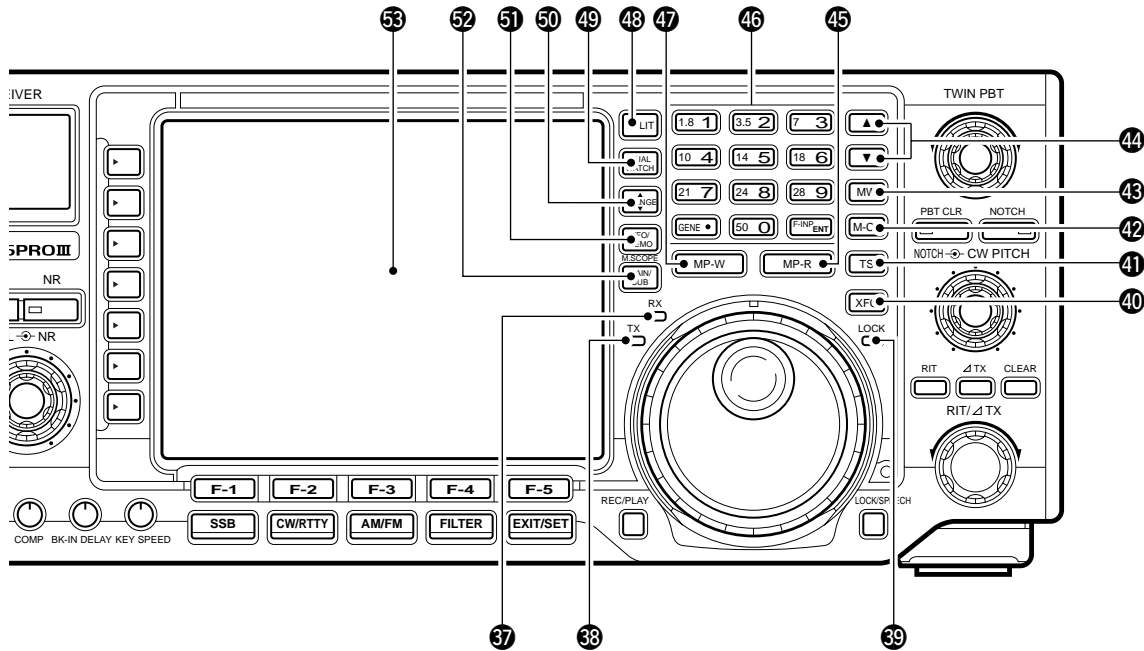

37 RECEIVE INDICATOR [RX]

Lights green while receiving a signal and when the squelch is open.

38 TRANSMIT INDICATOR [TX]

Lights red while transmitting.

39 LOCK INDICATOR [LOCK] (p. 65)

Lights red when the dial lock function is activated.

40 TRANSMIT FREQUENCY CHECK SWITCH [XFC]

Monitors the transmit frequency when pushed and held during the split frequency operation.

- While pushing this switch, the transmit frequency can be changed with the tuning dial, keypad, memo pad or the [▲]/[▼] switches.
- When the split lock function is turned ON, pushing [XFC] cancels the dial lock function. (p. 100)

41 QUICK TUNING SWITCH [TS] (p. 26)

- ➔ Turns the quick tuning step ON and OFF.
 - While the quick tuning indicator, “▼,” is displayed above the frequency indication, the frequency can be changed in programmed kHz steps.
 - 0.1, 1, 5, 9, 10, 12.5, 20 and 25 kHz quick tuning steps are available for each operating mode independently.

- ➔ When the quick tuning step is OFF, push for 1 sec. to turn the 1 Hz tuning step ON and OFF.
 - 1 Hz indications appear in both readouts and the frequency can be changed in 1 Hz steps.
- ➔ When the quick tuning step is ON, push for 1 sec. to enter the quick tuning step set mode.

42 MEMORY CLEAR SWITCH [M-CL] (p. 81)

- Clears the selected readout memory channel contents when pushed for 1 sec. in memory mode.
 - The channel becomes a blank channel.
 - This switch does not function in VFO mode.

43 MEMORY WRITE SWITCH [MW] (p. 79)

- Stores the selected readout frequency and operating mode into the displayed memory channel when pushed for 1 sec.
 - This function is available both in VFO and memory modes.

44 MEMORY UP/DOWN SWITCHES [▲]/[▼] (p. 77)

- ➔ Push to select the memory channel number for the selected readout.
 - Memory channels can be selected both in VFO and memory modes.
- ➔ Select the desired memory channel directly after pushing [(F-INP)ENT] and a memory channel number.

45 MEMO PAD-READ SWITCH [MP-R] (p. 82)

- Each pushing calls up a frequency and operating mode in a memo pad. The 5 (or 10) most recently programmed frequencies and operating modes can be recalled, starting from the most recent.
 - The memo pad capacity can be expanded from 5 to 10 in set mode for your convenience. (p. 102)

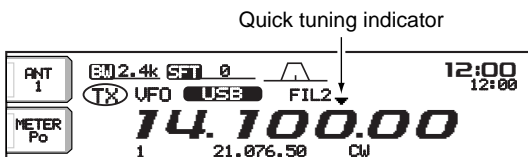

46 KEYPAD

- ➔ Pushing a key selects the operating band.
 - **[(GENE)]** selects the general coverage band.
- ➔ Pushing the same key 2 or 3 times calls up other stacked frequencies in the band. (p. 24)
 - Icom's triple band stacking register memorizes 3 frequencies in each band.
- ➔ After pushing **[(F-INP)ENT]**, enters a keyed frequency or memory channel. Pushing **[(F-INP)ENT]** or **[▲]/[▼]** is necessary at the end. (pgs. 25, 77)
 - e.g. to enter 14.195 MHz, push **[(F-INP)ENT] [1] [4] [.] [1] [9] [5] [(F-INP)ENT]**.

47 MEMO PAD-WRITE SWITCH [MP-W] (p. 82)

- Programs the selected readout frequency and operating mode into a memo pad.
- The 5 most recent entries remain in memo pads.
 - The transmit frequency is programmed when pushed together with **[XFC]**.
 - The memo pad capacity can be expanded from 5 to 10 in set mode for your convenience. (p. 102)

48 SPLIT SWITCH [SPLIT] (p. 71)

- ➔ Turns the split function ON and OFF when pushed.
- ➔ Turns the split function ON, equalizes the sub readout frequency to the main readout and sets the sub readout for frequency input when pushed for 1 sec. in non-FM modes. (Quick split function)
 - The offset frequency is shifted from the main readout frequency in FM mode. (pgs. 52, 100)
 - The quick split function can be turned OFF using set mode. (p. 100)
- ➔ Turns the split function ON and shifts the sub readout frequency after input an offset (± 4 MHz in 1 kHz steps).

49 DUALWATCH SWITCH [DUALWATCH] (p. 63)

- ➔ Turns the dualwatch function ON and OFF when pushed.
- ➔ Turns the dualwatch function ON and equalizes the sub readout frequency to the main readout when pushed for 1 sec. (Quick dualwatch function)
 - The quick dualwatch function can be turned OFF using set mode. (p. 98)

50 MAIN/SUB CHANGE SWITCH [CHANGE]

- ➔ Switches the frequency and selected memory channel between main and sub readouts when pushed.
 - Switches between transmit frequency and receive frequency when the split frequency function is ON. (p. 71)
- ➔ Equalizes the sub readout frequency to the main readout frequency when pushed for 1 sec.

51 VFO/MEMORY SWITCH [VFO/MEMO]

- ➔ Switches the selected readout operating mode between the VFO mode and memory mode when pushed. (pgs. 23, 77)
- ➔ Transfers the memory contents to VFO when pushed for 1 sec. (p. 80)

52 MAIN/SUB•M.SCOPE SWITCH [MAIN/SUB•M.SCOPE]

- ➔ Push momentarily to select access to the main or sub readout. (p. 23)
 - The sub readout frequency is displayed in outline or mesh font. The sub readout functions only during split operation or dualwatch.
- ➔ Push for 1 sec. to turn the mini spectrum scope screen indication ON and OFF. (p. 55)
 - The mini spectrum scope screen can be indicated with another screen, such as memory, set mode screen, simultaneously.

53 LCD FUNCTION DISPLAY (See p. 9 for details.)

- Shows the operating frequency, function switch menus, spectrum scope screen, memory channel screen, set mode settings, etc.

LCD display

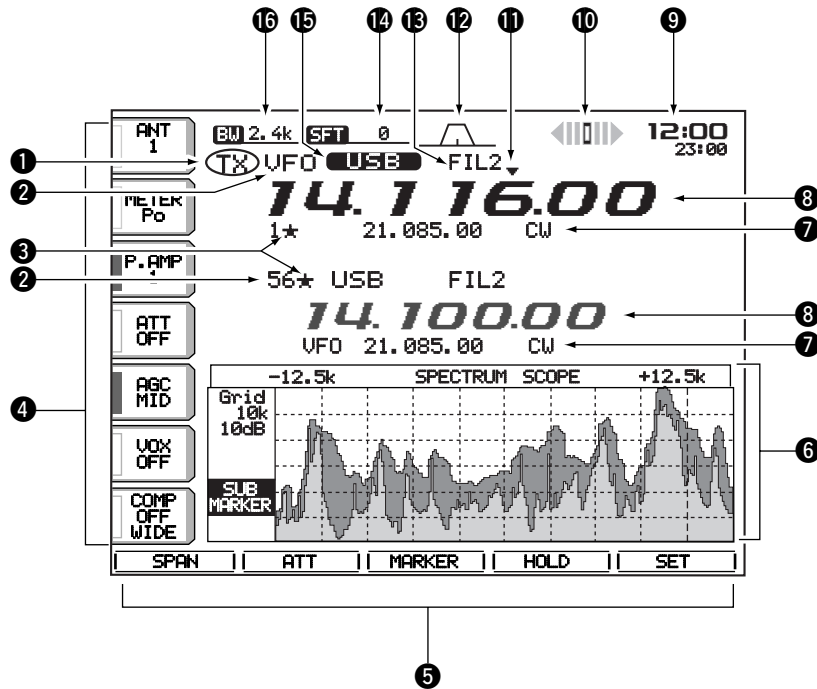

- 1 TX INDICATOR**
Indicates the frequency readout for transmission.
- 2 VFO/MEMORY CHANNEL INDICATOR** (pgs. 23, 77)
Indicates the VFO mode or selected memory channel number.
- 3 SELECT MEMORY CHANNEL INDICATOR** (p. 86)
Indicates the displayed memory channel is set as a select memory channel.
- 4 MULTI-FUNCTION SWITCH GUIDE**
Indicates the function of the multi-function switches.
- 5 LCD FUNCTION SWITCH GUIDE**
Indicates the function of the LCD function switches ([F-1]–[F-5]).
- 6 MULTI-FUNCTION SCREEN** (p. 10)
Shows the screens for the multi-function digital meter, spectrum scope, voice recorder, memory channel, scan, memory keyer, RTTY decoder, IF filter selection or set modes, etc.
- 7 MEMORY CHANNEL READOUTS** (p. 77)
 - ➔ Show the selected memory channel contents in VFO mode.
 - ➔ Show the VFO contents in memory mode.
- 8 FREQUENCY READOUTS** (p. 25)
Show the operating frequency.
• Outline characters are used for non-accessing readout.
- 9 CLOCK READOUT** (p. 92)
Shows the current time.
• Dualtime indication is available.
- 10 RTTY TUNING INDICATOR** (p. 47)
Shows the tuning level in RTTY mode.
- 11 QUICK TUNING INDICATOR** (p. 26)
Appears when the quick tuning step function is in use.
- 12 PASSBAND WIDTH INDICATOR** (pgs. 60, 61)
Graphically displays the passband width for twin PBT operation and center frequency for IF shift operation.
- 13 IF FILTER INDICATOR** (p. 61)
Shows the selected IF filter number.
- 14 SHIFT FREQUENCY INDICATOR** (p. 60)
Shows the shift frequency of the IF filter.
- 15 MODE INDICATOR** (p. 29)
Shows the selected mode.
- 16 BAND WIDTH INDICATOR** (p. 61)
Shows the passband width of the IF filter.

Screen menu arrangement

The following screens can be selected from the start up screen. Choose the desired screen using the following chart.

Pushing [EXIT/SET] several times returns to the start up screen. See p. 94 for set mode arrangement.

• Start up screen

ANT 1 12:00
12:00
14.100.00
VFO USB FIL2
14.100.00
1

SCOPE | VOICE | KEYS | MEMORY | SCAN

F-1 F-2 F-3 F-4 F-5

• Spectrum scope screen (p. 55)

AGC MID -12.5k SPECTRUM SCOPE +12.5k
Grid 2.5k 10dB
BK-IN OFF
1/4 OFF

SPAN | ATT | MARKER | HOLD | SET

• Voice recorder screen (p. 73)

VOICE RECORDER

T1	---
T2	---
T3	---
T4	---

MEMORY

T1 | T2 | T3 | T4 | T/R

• Memory channel screen (p. 78)

MEMORY

99	---	---	---	---
P1	0.500.00	USB	FL2	SCAN EDGE
P2	29.999.99	USB	FL2	SCAN EDGE
1	---	---	---	---
2	---	---	---	---
3	---	---	---	---
4	---	---	---	---

ROLL | SET | SELECT | NAME | WIDE

• Memory keyer screen (CW mode: p. 40)

MEMORY KEYS

M1	CQ TEST CQ TEST DE ICOM ICOM TEST
M2	UR 5NN001 BK
M3	CFM TU
M4	QRZ?

M1 | M2 | M3 | M4 | -1

• Programmed scan screen (VFO mode: p. 84)

SCAN

ΔF Span : ± 10kHz
Programmed P1: 0.500.00MHz
scan edges P2: 29.999.99MHz

PROG | ΔF | FINE | ΔF SPAN | SET

• RTTY decoder screen (RTTY mode: p. 46)

RTTY DECODE

*** RTTY Decode Monitor ***
45bps BAUDOT Mark=2125, Shift=170
UnShift On Space support (SET-OTHERS)
New Line Code selectable (SET-OTHERS)
If RTTY-FIL is OFF, Please turn ON.

THRESHOLD 9

<MENU> | HLD/CLR | TX MEM | ADJ | WIDE

• Memory scan screen (Memory mode: p. 85)

SCAN

ΔF Span : ± 10kHz
Programmed P1: 0.500.00MHz
scan edges P2: 29.999.99MHz

MEMO | ΔF | SELECT | ΔF SPAN | SET

■ Rear panel

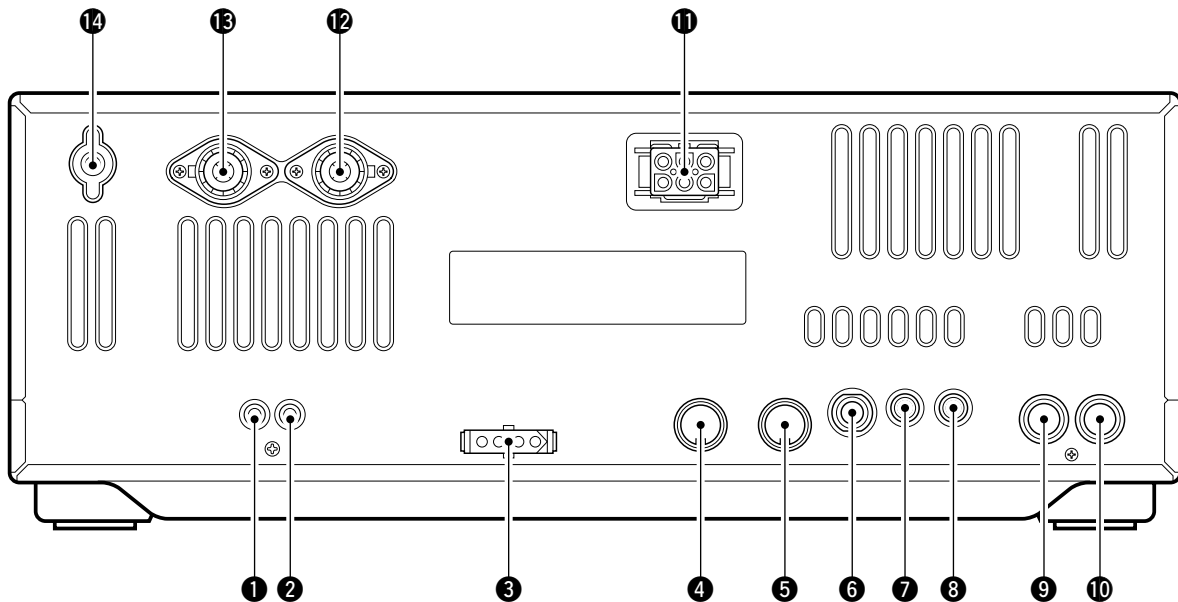

- 1 TRANSVERTER JACK [XVERT]** (p. 18)
External transverter input/output jack. Activated by voltage applied to [ACC(2)] pin 6.
- 2 RECEIVE ANTENNA CONNECTOR [RX ANT]** (p. 15)
Connects a 50 Ω general coverage antenna with an RCA connector.
- 3 TUNER CONTROL SOCKET [TUNER]** (p. 15)
Accepts the control cable from an optional AH-4 HF/50 MHz AUTOMATIC ANTENNA TUNER or AH-3 HF AUTOMATIC ANTENNA TUNER.
- 4 ACCESSORY SOCKET 1 [ACC(1)]**
- 5 ACCESSORY SOCKET 2 [ACC(2)]**
Enable connection of external equipment such as a linear amplifier, an automatic antenna selector/tuner, TNC for data communications, etc.
• See p. 20 for socket information.
- 6 STRAIGHT KEY JACK [KEY]** (p. 14)
Accepts a straight key or external electronic keyer with ¼ inch standard plug.
• [ELEC-KEY] on the front panel can be used for a straight key or external electronic keyer. Deactivate the internal electronic keyer in keyer set mode. (p. 43)
- 7 CI-V REMOTE CONTROL JACK [REMOTE]** (p. 110)
➔ Connects a PC via the optional CT-17 CI-V LEVEL CONVERTER for external control of the transceiver functions.
➔ Used for transceive operation with another Icom CI-V transceiver or receiver.
- 8 EXTERNAL SPEAKER JACK [EXT SP]** (pgs. 15, 116)
Accepts an 4–8 Ω speaker.
- 9 ALC INPUT JACK [ALC]** (p. 17)
Connects to the ALC output jack of a non-Icom linear amplifier.
- 10 SEND CONTROL JACK [SEND]** (p. 17)
Goes to ground while transmitting to control external equipment such as a linear amplifier.
• Max. control level: 16 V DC/0.5 A
- 11 DC POWER SOCKET [DC 13.8V]** (p. 16)
Accepts 13.8 V DC through the supplied DC power cable (OPC-025D).

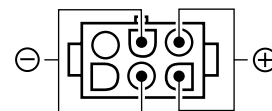
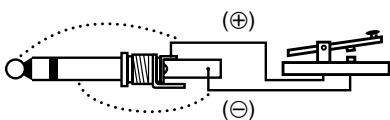

Rear panel view

▨ If you use an external electronic keyer, make sure the voltage retained by the keyer is less than 0.4 V when the key is ON.

- 12 ANTENNA CONNECTOR 1 [ANT1]
- 13 ANTENNA CONNECTOR 2 [ANT2] (pgs. 13, 14)
Accept a 50 Ω antenna with a PL-259 connector.

When using an optional AH-4 HF/50 MHz AUTOMATIC ANTENNA TUNER or AH-3 HF AUTOMATIC ANTENNA TUNER, connect it to the [ANT1] connector. The internal antenna tuner activates for [ANT2] and deactivates for [ANT1] when connecting the AH-4 or AH-3.

- 14 GROUND TERMINAL [GND] (pgs. 13, 14)
Connect this terminal to a ground to prevent electrical shocks, TVI, BCI and other problems.

Microphone (HM-36)

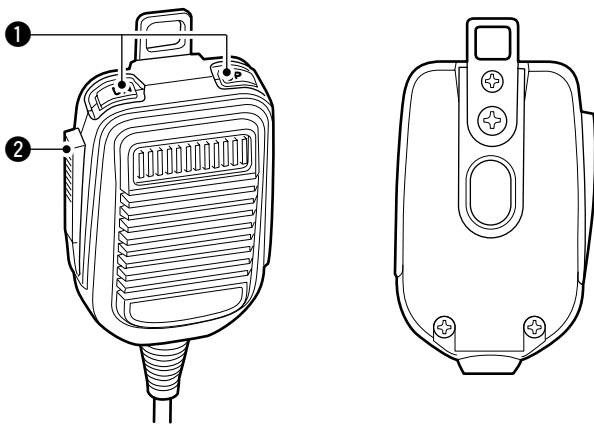

- 1 UP/DOWN SWITCHES [UP]/[DN]
Change the selected readout frequency or memory channel.
 - Continuous pushing changes the frequency or memory channel number continuously.
 - While pushing [XFC], the transmit readout frequency can be controlled while in split frequency operation.
 - The [UP]/[DN] switch can simulate a key paddle. Preset in the keyer set mode. (p. 43)

- 2 PTT SWITCH
Push and hold to transmit; release to receive.

• HM-36 SCHEMATIC DIAGRAM

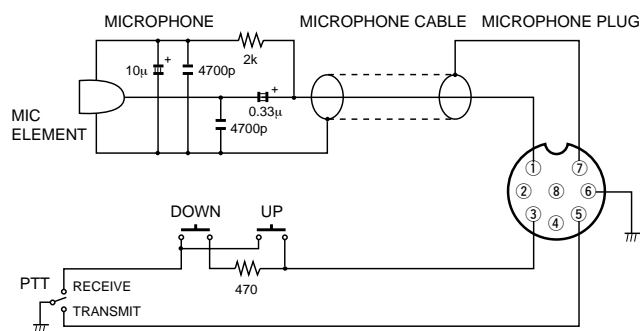

■ Unpacking

After unpacking, immediately report any damage to the delivering carrier or dealer. Keep the shipping cartons.

For a description and a diagram of accessory equipment included with the IC-756PROIII, see 'Supplied accessories' on p. i of this manual.

■ Selecting a location

Select a location for the transceiver that allows adequate air circulation, free from extreme heat, cold, or vibrations, and away from TV sets, TV antenna elements, radios and other electromagnetic sources.

The base of the transceiver has an adjustable stand for desktop use. Set the stand to one of two angles depending on your operating conditions.

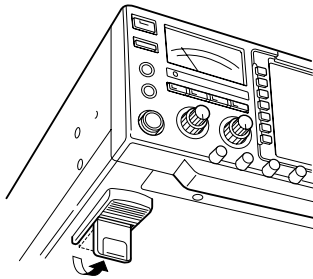

■ Grounding

To prevent electrical shock, television interference (TVI), broadcast interference (BCI) and other problems, ground the transceiver through the GROUND terminal on the rear panel.

For best results, connect a heavy gauge wire or strap to a long earth-sunk copper rod. Make the distance between the [GND] terminal and ground as short as possible.

WARNING: NEVER connect the [GND] terminal to a gas or electric pipe, since the connection could cause an explosion or electric shock.

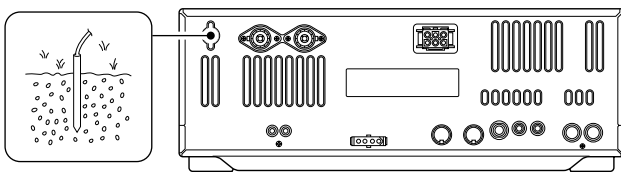

■ Antenna connection

For radio communications, the antenna is of critical importance, along with output power and sensitivity. Select antenna(s), such as a well-matched 50 Ω antenna, and feedline. 1.5:1 or better of Voltage Standing Wave Ratio (VSWR) is recommended for your desired band. Of course, the transmission line should be a coaxial cable.

When using 1 antenna, use the [ANT1] connector.

CAUTION: Protect your transceiver from lightning by using a lightning arrester.

PL-259 CONNECTOR INSTALLATION EXAMPLE

- ① Slide the coupling ring down. Strip the cable jacket and soft solder.
 - ② Strip the cable as shown at left. Soft solder the center conductor.
 - ③ Slide the connector body on and solder it.
 - ④ Screw the coupling ring onto the connector body.
- 30 mm ≈ 3/8 in 10 mm ≈ 3/8 in 1-2 mm ≈ 1/16 in

Antenna SWR

Each antenna is tuned for a specified frequency range and SWR may be increased out-of-range. When the SWR is higher than approx. 2.0:1, the transceiver's power drops to protect the final transistor. In this case, an antenna tuner is useful to match the transceiver and antenna. Low SWR allows full power for transmitting even when using the antenna tuner. The IC-756PROIII has an SWR meter to monitor the antenna SWR continuously.

Required connections

Front panel

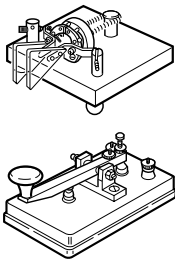

CW KEY

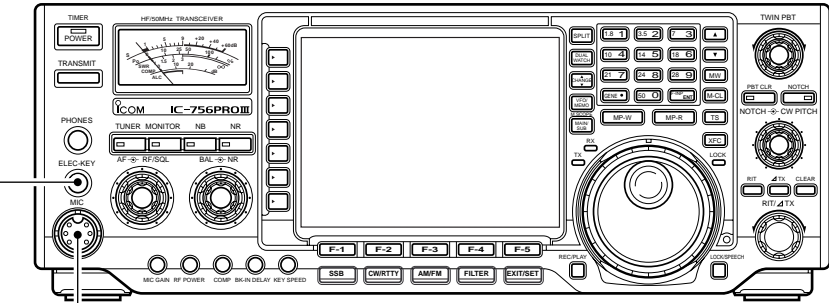

A straight key can be used when the internal electronic keyer is turned OFF in keyer set mode. (p. 43)

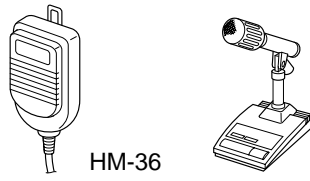

MICROPHONES (p. 116)

HM-36 SM-20

Rear panel

ANTENNA 1, 2 (p. 13)
 [Example]: ANT1 for 1.8–18 MHz bands
 ANT2 for 21–50 MHz bands

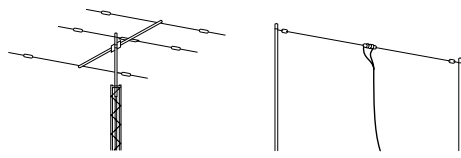

DC POWER SUPPLY (p.16)

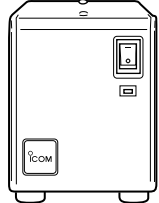

PS-125

GROUND (p. 13)

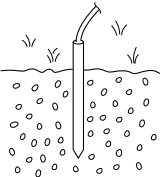

Use the heaviest gauge wire or strap available and make the connection as short as possible.

Grounding prevents electrical shocks, TVI and other problems.

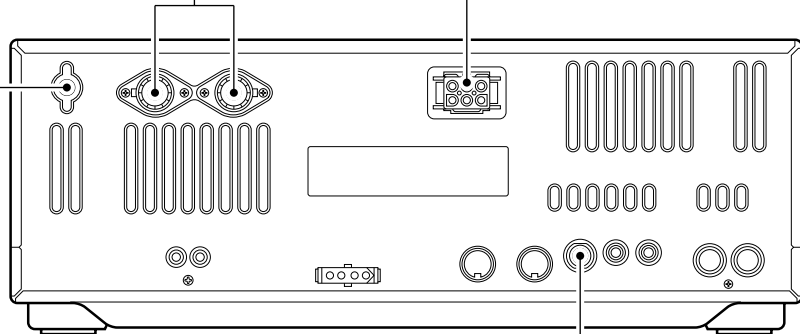

STRAIGHT KEY

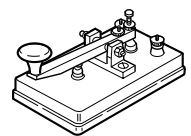

■ Advanced connections

• Front panel

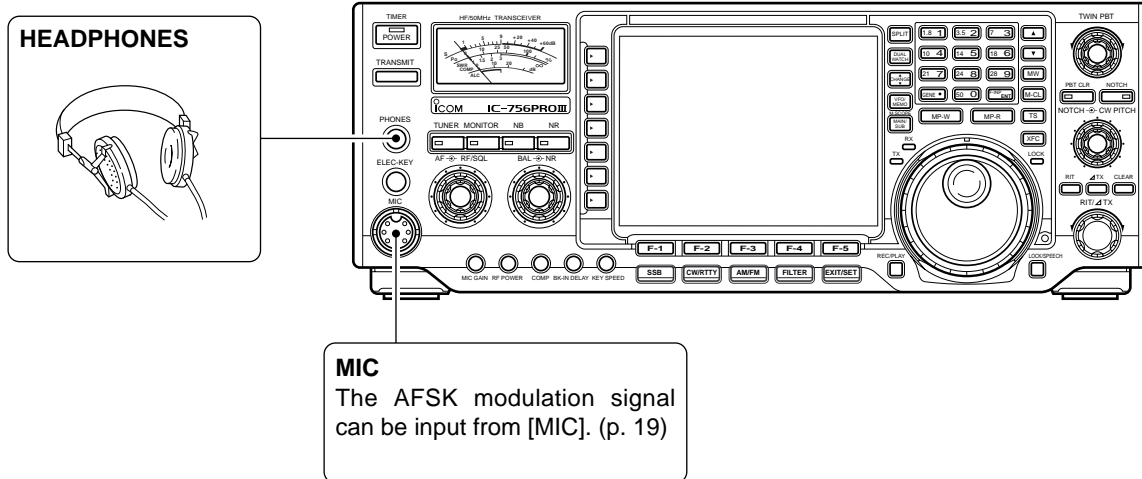

• Rear panel

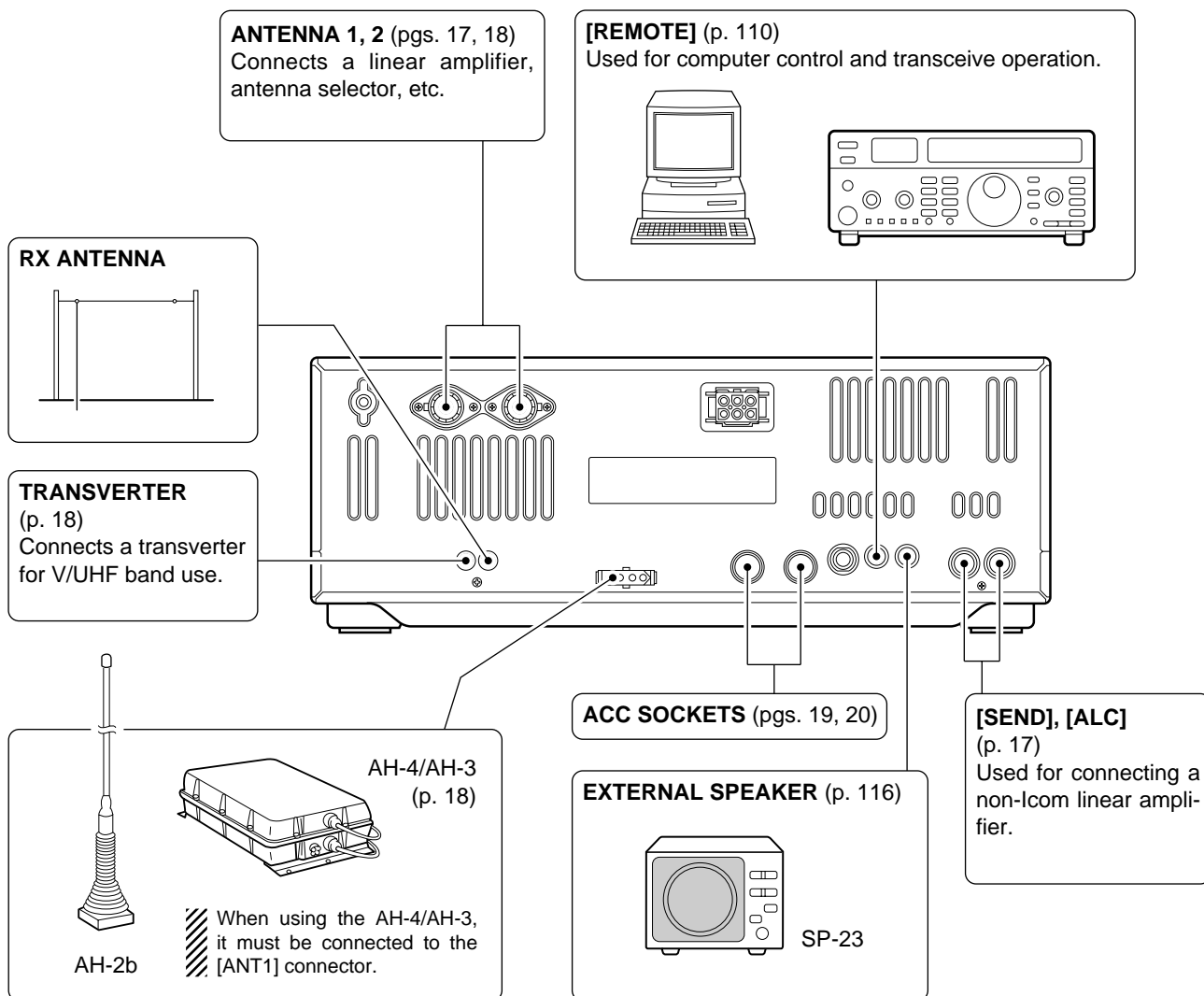

Power supply connections

Use the optional PS-125 DC power supply with a 25 A capacity when operating the transceiver with AC power. Refer to the diagrams below.

CAUTION: Before connecting the DC power cable, check the following important items. Make sure:

- The **[POWER]** switch is OFF.
- Output voltage of the power source is 12–15 V when you use a non-Icom power supply.
- DC power cable polarity is correct.
 - Red : positive ⊕ terminal
 - Black : negative ⊖ terminal

CONNECTING PS-125 DC POWER SUPPLY

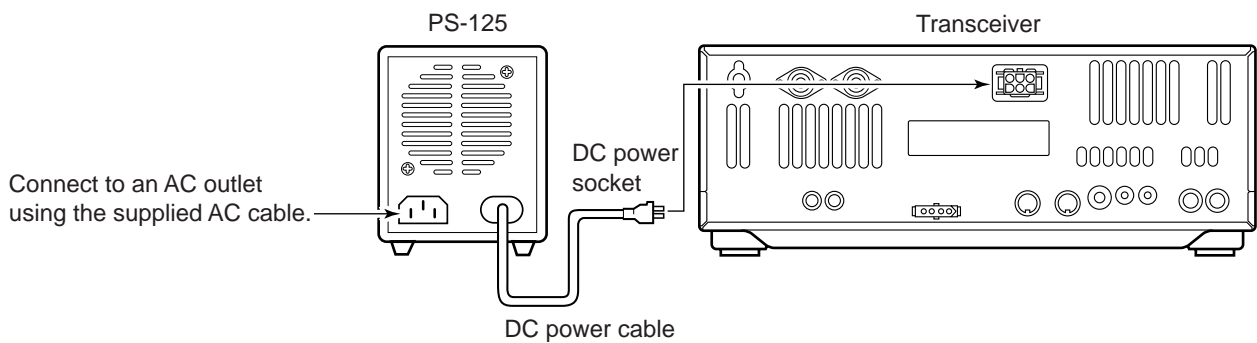

CONNECTING A DC POWER SUPPLY

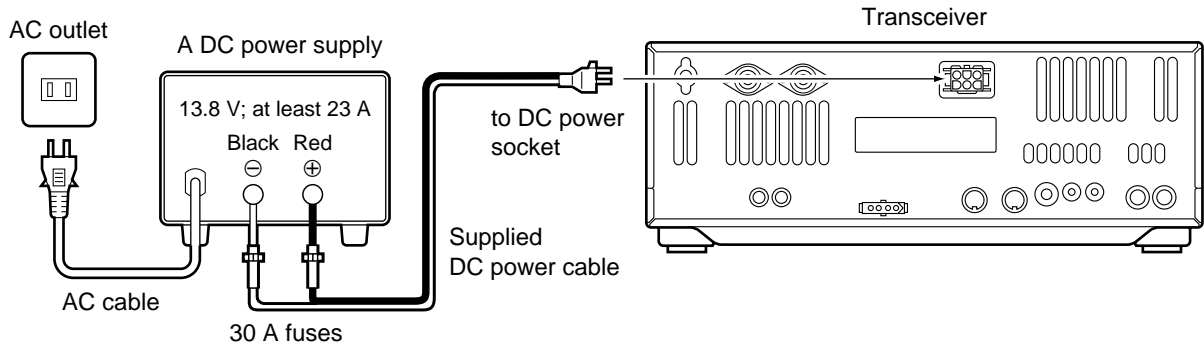

CONNECTING A VEHICLE BATTERY

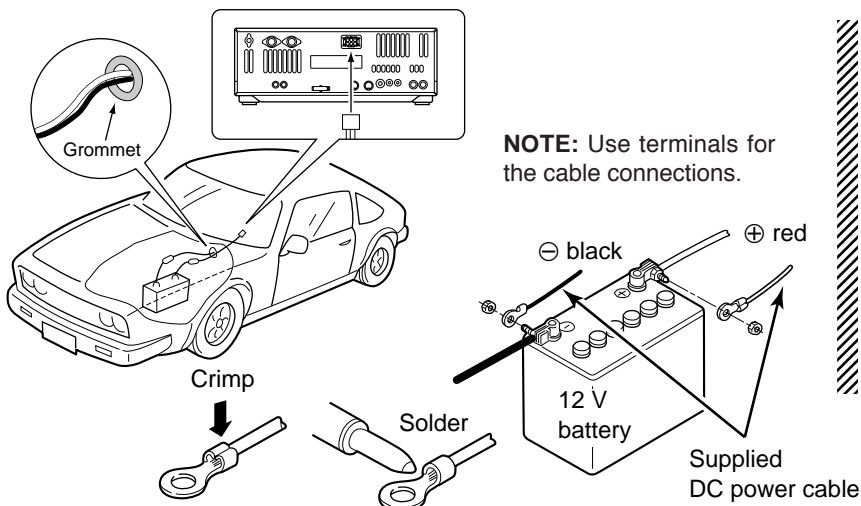

⚠ WARNING NEVER connect to a battery without supplied DC fuses, otherwise a fire hazard may occur.

NEVER connect the transceiver directly to a 24 V battery.

IMPORTANT! Detailed installation notes for Icom mobile transceivers to be fitted into vehicles are available. Contact your Icom dealer or distributor.

■ Linear amplifier connections

Use the [ANT1] connector when connecting a linear amplifier.

CONNECTING THE IC-PW1/EURO

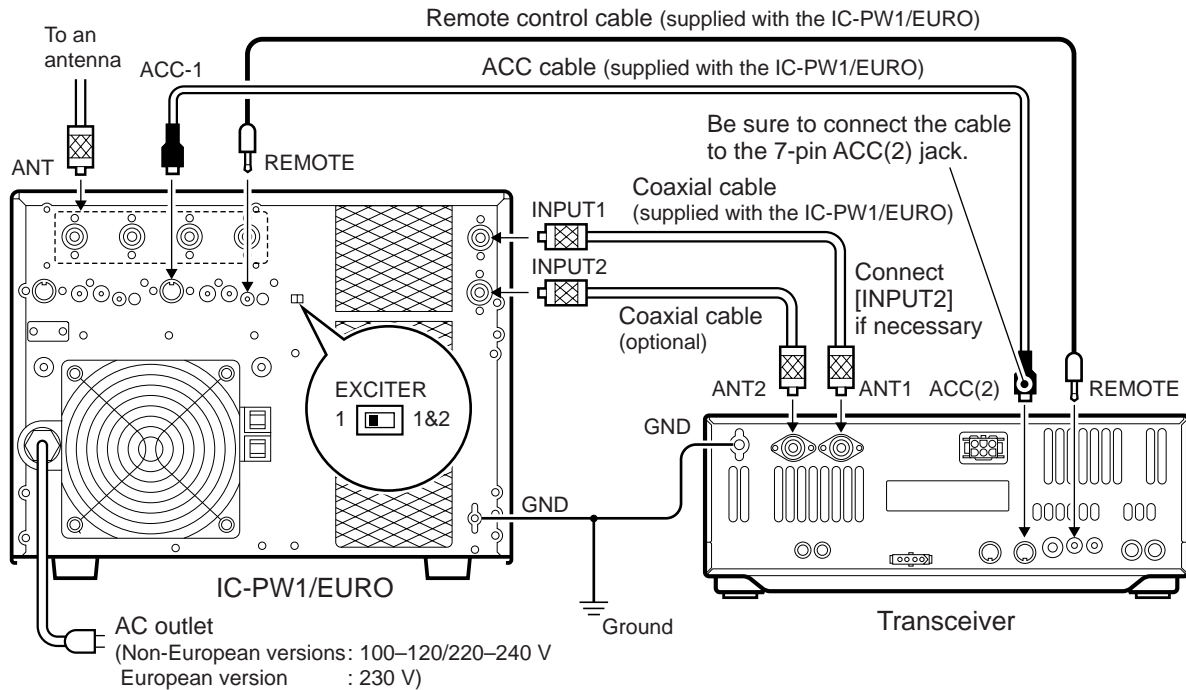

⚡ Turn OFF the transceiver's antenna tuner while tuning the IC-PW1/EURO's tuner.

CONNECTING A NON-ICOM LINEAR AMPLIFIER

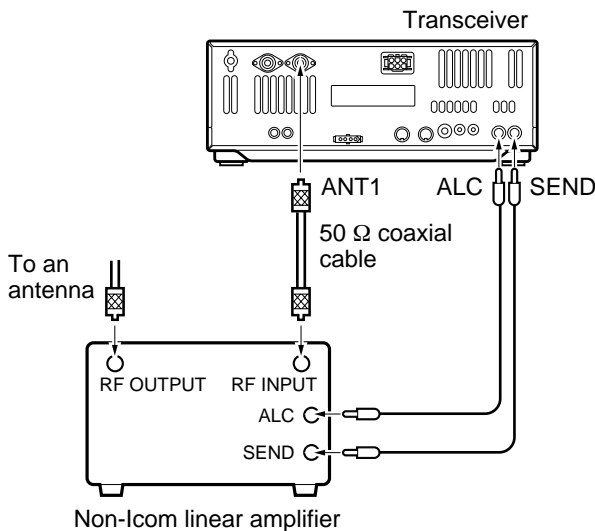

⚠ WARNING:

Set the transceiver output power and linear amplifier ALC output level referring to the linear amplifier instruction manual.

The ALC input level must be in the range 0 V to -4 V, and the transceiver does not accept positive voltage. Non-matched ALC and RF power settings could cause a fire or ruin the linear amplifier.

The specifications for the SEND relay are 16 V DC 0.5 A. If this level is exceeded, a large external relay must be used.

External antenna tuner connection

CONNECTING THE AH-4/AH-3

⚡ The AH-4 or AH-3 must be connected to [ANT1].

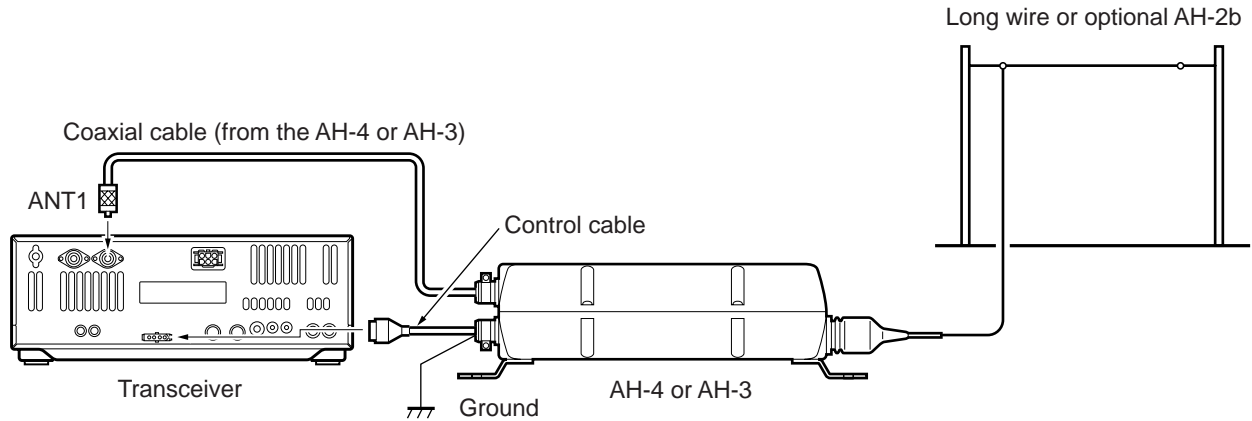

2

Transverter jack information

When 2 to 13.8 V is applied to pin 6 of [ACC(2)], the [XVERT] jack is activated for transverter operation and the antenna connectors do not receive or transmit any signals. (p. 20)

While receiving, the [XVERT] jack can be activated as an input terminal from an external transverter.

While transmitting, the [XVERT] jack outputs signals of the displayed frequency at -20 dBm (22 mV) as signals for the external transverter.

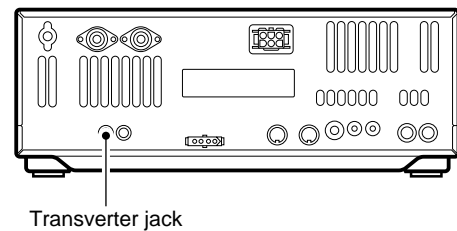

Microphone connector information

(Front panel view)

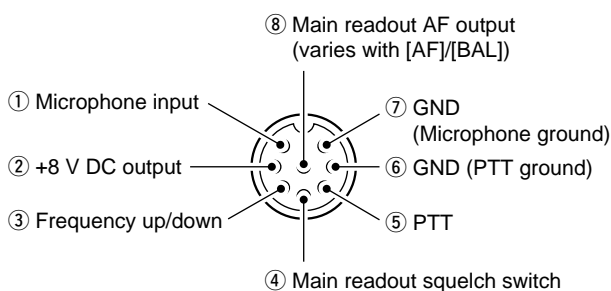

[MIC] Pin No.	FUNCTION	DESCRIPTION
②	+8 V DC output	Max. 10 mA
③	Frequency up	Ground
	Frequency down	Ground through 470 Ω
④	Squelch open	"Low" level
	Squelch closed	"High" level

⚡ **CAUTION: DO NOT** short pin 2 to ground as this can damage the internal 8 V regulator.

⚡ **NOTE:** DC voltage is applied to pin 1 for microphone operation. Take care when using a non-Icom microphone.

■ FSK and AFSK (SSTV) connections

To connect a terminal unit, TNC or scan converter, refer to the diagram below.

For RTTY operation:

- ▨ Narrow filter settings may not pass RTTY signals.
- ▨ Be sure to select the appropriate IF filter settings corresponding to the signal width. (p. 61)

FSK (RTTY) connection

Use RTTY mode for operation

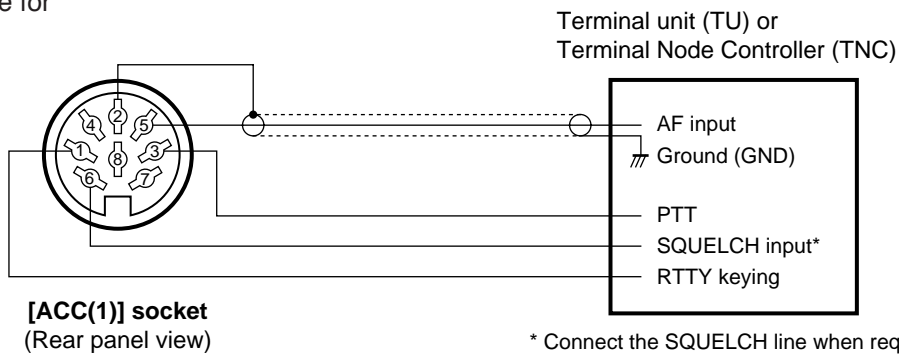

* Connect the SQUELCH line when required.

AFSK and SSTV connections

Use SSB or FM mode for operation

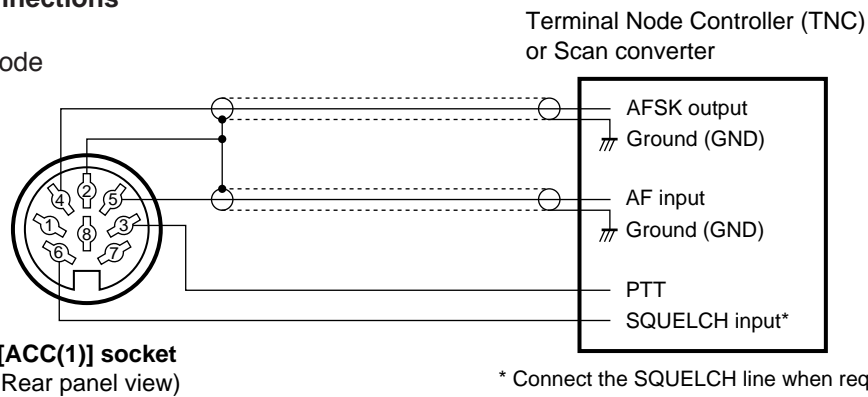

* Connect the SQUELCH line when required.

AFSK and SSTV connections via microphone connector

Use SSB or FM mode for operation

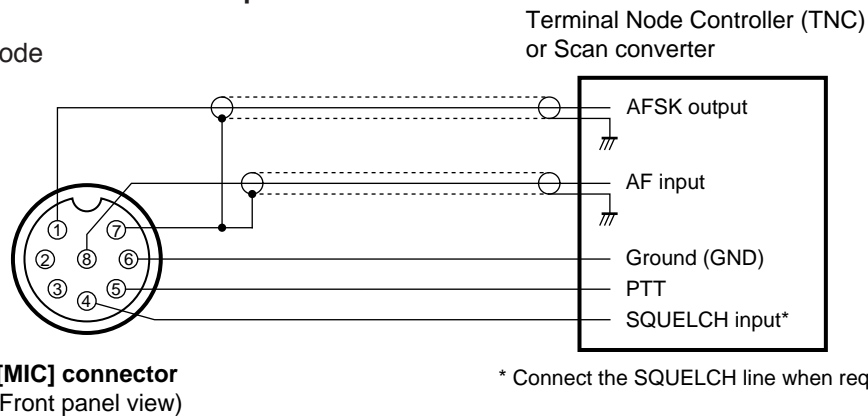

* Connect the SQUELCH line when required.

▨ When connected to the [MIC] connector, [MIC GAIN] and [AF] control adjustment is required.

■ Accessory connector information

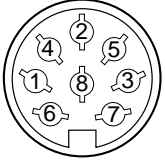
ACC (1)	PIN No.	NAME	DESCRIPTION	SPECIFICATIONS
 <p>Rear panel view</p>	1	RTTY	Controls RTTY keying	“High” level : More than 2.4 V “Low” level : Less than 0.6 V Output current : Less than 2 mA
	2	GND	Connects to ground.	Connected in parallel with ACC(2) pin 2.
	3	SEND	Input/output pin. Goes to ground when transmitting. When grounded, transmits.	Ground level : -0.5 V to 0.8 V Output current : Less than 20 mA Input current (Tx) : Less than 200 mA Connected in parallel with ACC(2) pin 3.
	4	MOD	Modulator input. Connects to a modulator.	Input impedance : 10 kΩ Input level : Approx. 100 mV rms
	5	AF	AF detector output. Fixed, regardless of [AF] position in default settings. (see notes below)	Output impedance : 4.7 kΩ Output level : 100–300 mV rms
	6	SQLS	Squelch output. Goes to ground when squelch opens.	SQL open : Less than 0.3 V/5 mA SQL closed : More than 6.0 V/100 μA
	7	13.8 V	13.8 V output when power is ON.	Output current : Max. 1 A Connected in parallel with ACC(2) pin 7.
	8	ALC	ALC voltage input.	Control voltage : -4 V to 0 V Input impedance : More than 10 kΩ Connected in parallel with ACC(2) pin 5.

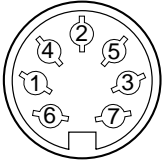
ACC (2)	PIN No.	NAME	DESCRIPTION	SPECIFICATIONS
 <p>Rear panel view</p>	1	8 V	Regulated 8 V output.	Output voltage : 8 V ±0.3 V Output current : Less than 10 mA
	2	GND	Same as ACC(1) pin 2.	
	3	SEND	Same as ACC(1) pin 3.	
	4	BAND	Band voltage output. (Varies with amateur band)	Output voltage : 0 to 8.0 V
	5	ALC	Same as ACC (1) pin 8.	
	6	TRV	Activates [XVERT] input/output when “HIGH” voltage is applied.	Input impedance : More than 10 kΩ Input voltage : 2 to 13.8 V
	7	13.8 V	Same as ACC(1) pin 7.	

/// If the CW side tone level limit or beep level limit is in use, the CW side tone or beep tone decreases from the fixed level when the [AF] control is rotated above a specified level, respectively. (p. 96)

■ When first applying power (CPU resetting)

Before first applying power, make sure all connections required for your system are complete by referring to Section 2. Then, reset the transceiver using the following procedure.

Resetting **CLEARs** all programmed contents in memory channels and returns programmed values in set mode to default values.

- ① Make sure the transceiver power is OFF.
- ② While pushing **[M-CL]** and **[(F-INP)ENT]**, push **[POWER]** to turn power ON.
 - The internal CPU is reset.
 - A/D convertor calibration of the DSP unit starts and it takes 10 sec.
 - The transceiver displays its initial VFO frequencies when resetting is complete.
- ③ Correct the set mode settings after resetting, if desired.

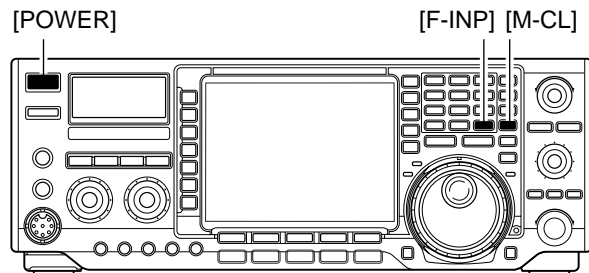

Under cooler temperatures, the LCD may appear dark and unstable after turning power ON. This is normal and does not indicate any equipment malfunction.

■ Initial settings

After resetting the transceiver, set controls and switches as shown in the figure below.

CW : Max. clockwise
CCW : Max. counterclockwise

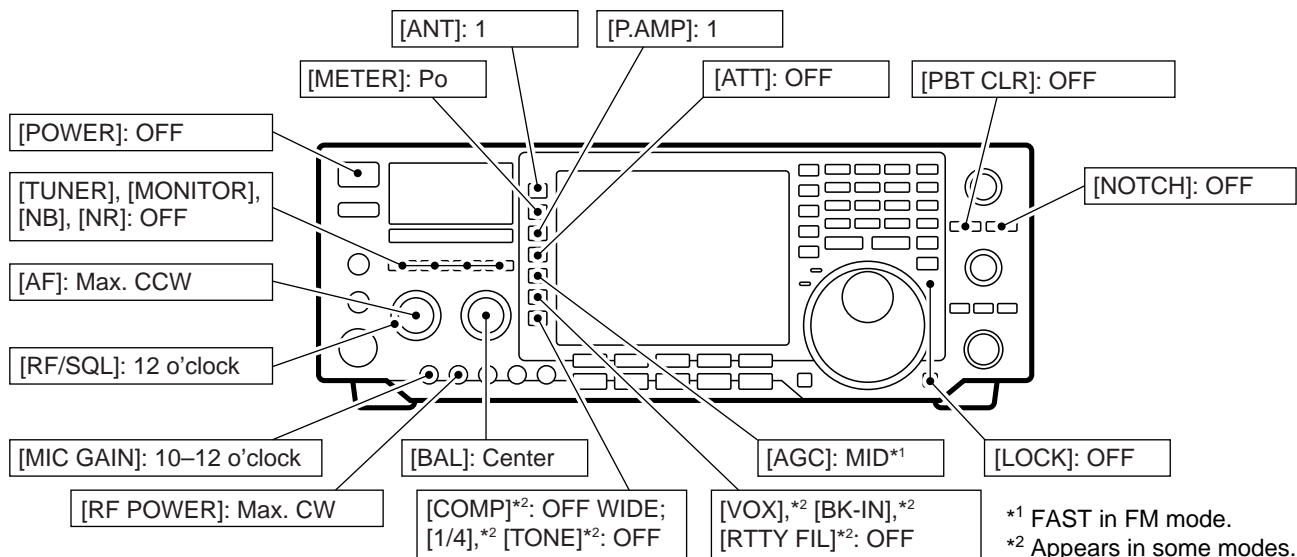

Turn power ON, then check the display. If any of the following indicators appear, turn them OFF as follows:

- Quick tuning step indicator “▼” : Push **[TS]**.
- 1 Hz frequency readout : Push **[TS]** for 2 sec. (while quick tuning step is OFF)
- RIT indicator “**RIT**” : Push **[RIT]**.
- ΔTX indicator “**ΔTX**” : Push **[ΔTX]**.
- Split indicator “**SPLIT**” : Push **[SPLIT]**.

- Dualwatch indicator “**DUAL-W**” : Push **[DUALWATCH]**.
- Twin peak filter indicator “**TPF**” : Push **[RTTY FIL]**.
- Auto notch indicator “**AN**” : Push **[NOTCH]**.
- Manual notch indicator “**MN**” : Push **[NOTCH]**.

VFO description

VFO is an abbreviation of Variable Frequency Oscillator, and traditionally refers to an oscillator.

The transceiver's VFO is somewhat different. The VFO of the IC-756PROIII acts like a computer's window and can show one frequency and one operating mode.

You can call up a desired frequency to the VFO with the keypad, memo pad-read switch (see p. 82) or the memory transfer function (see p. 80). You can also change the frequency with the tuning dial and select the operating mode with the mode switches.

During dualwatch or split frequency operation, the sub VFO is functional (non-outline, non-spotted, larger frequency characters). While pushing [XFC] during split frequency operation, you can change the transmit readout frequency with the keypad, memo pad-read switch or the memory transfer function.

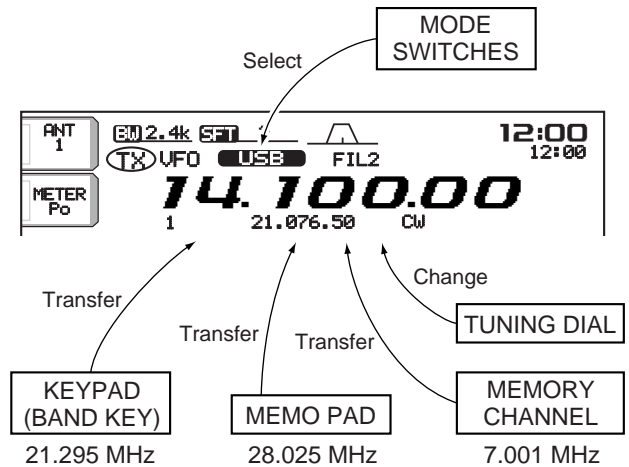

Differences between VFO mode and memory mode

VFO MODE

VFO shows a frequency and operating mode. If the frequency or operating mode is changed, the VFO automatically memorizes the new frequency or new operating mode.

When a VFO is selected from another band or memory mode, the frequency and operating mode last used for that VFO appear.

[EXAMPLE]

VFO is selected.

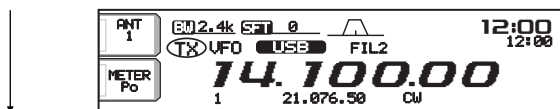

The frequency is changed.

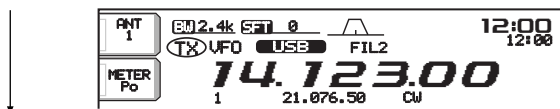

Memory mode is selected.

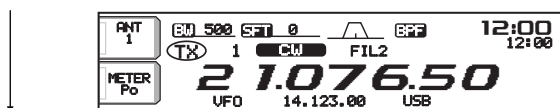

VFO is selected again.

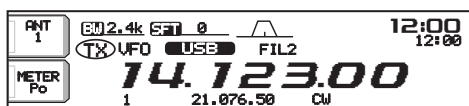

Changed frequency (14.123 MHz) appears.

MEMORY MODE (pgs. 77–81)

Each memory channel shows a frequency and operating mode like a VFO. Even if the frequency or mode is changed, the memory channel does not memorize the new frequency or operating mode.

When the memory channel is selected from another memory channel or VFO mode, the memorized frequency and operating mode appear.

[EXAMPLE]

Memory channel 1 is selected.

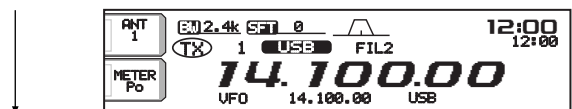

The frequency is changed.

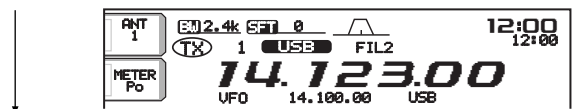

Another memory channel is selected.

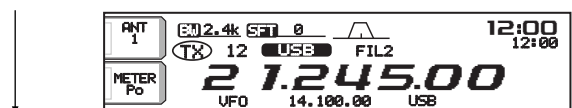

Memory channel 1 is selected again.

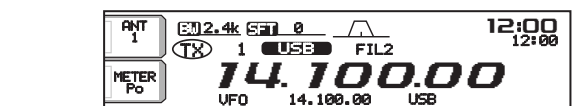

Changed frequency (14.123 MHz) does not appear and memorized frequency (14.100 MHz) appears instead.

■ Selecting VFO/memory mode

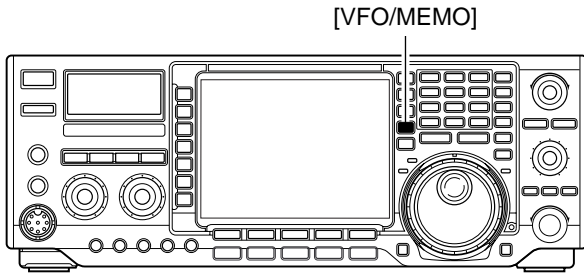

➔ Push **[VFO/MEMO]** to switch between VFO and memory modes.

- “VFO” appears when VFO mode, or the selected memory channel number appears when memory mode is selected beside the frequency readout.
- Pushing **[VFO/MEMO]** for 1 sec. transfers the contents of the selected memory channel to VFO mode. (p. 80)

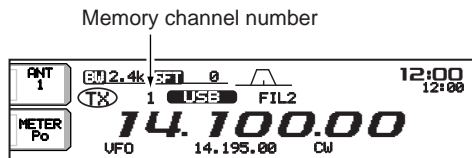
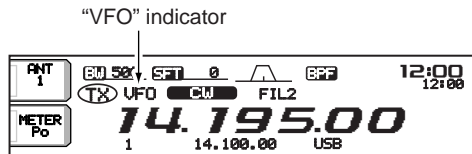

■ Main/Sub band selection

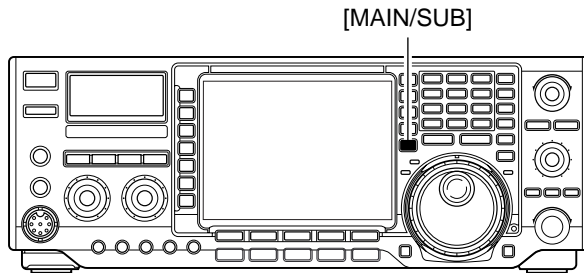

➔ Push **[MAIN/SUB]** to select access to the main or sub readout.

- The sub readout frequency is displayed in outline or mesh font. The sub readout functions only during split operation or dualwatch.

■ Selecting an operating band

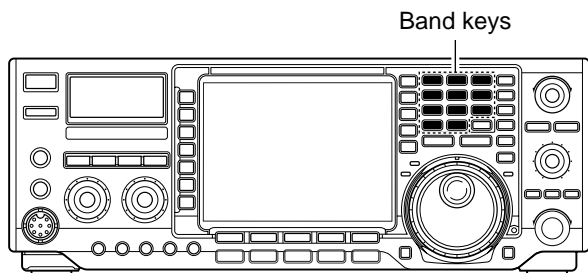

The triple band stacking register provides 3 memories in one band. 3 sets of a frequency and operating mode on each band are automatically stored when used.

If a band key is pushed once, the frequency and operating mode last used are called up. When the key is pushed again, another stored frequency and operating mode are called up.

This function is convenient when you operate 3 operating modes on one band. For example, one register is used for a CW frequency, another for an SSB frequency and the other one for an RTTY frequency.

See the table below for a list of the band available and the default settings for each band.

BAND	REGISTER 1	REGISTER 2	REGISTER 3
1.8 MHz	1.900000 MHz CW	1.910000 MHz CW	1.915000 MHz CW
3.5 MHz	3.550000 MHz LSB	3.560000 MHz LSB	3.580000 MHz LSB
7 MHz	7.050000 MHz LSB	7.060000 MHz LSB	7.020000 MHz CW
10 MHz	10.120000 MHz CW	10.130000 MHz CW	10.140000 MHz CW
14 MHz	14.100000 MHz USB	14.200000 MHz USB	14.050000 MHz CW
18 MHz	18.100000 MHz USB	18.130000 MHz USB	18.150000 MHz USB
21 MHz	21.200000 MHz USB	21.300000 MHz USB	21.050000 MHz CW
24 MHz	24.950000 MHz USB	24.980000 MHz USB	24.900000 MHz CW
28 MHz	28.500000 MHz USB	29.500000 MHz USB	28.100000 MHz CW
50 MHz	50.100000 MHz USB	50.200000 MHz USB	51.000000 MHz FM
General	15.000000 MHz USB	15.100000 MHz USB	15.200000 MHz USB

◇ Using the band stacking registers

[Example]: 14 MHz band

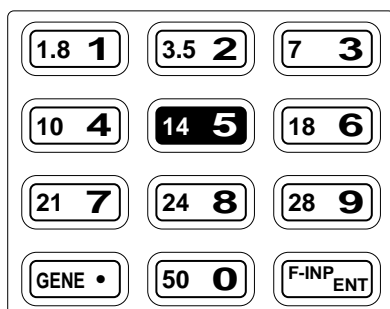

- ① Push **[(14)5]**, then select a frequency and an operating mode.
 - Frequency and operating mode are memorized in the first band stacking register.
- ② Push **[(14)5]** again, then select another frequency and operating mode.
 - This frequency and operating mode are memorized in the second band stacking register.
- ③ Push **[(14)5]** again, then select another frequency and operating mode.
 - This frequency and operating mode are memorized in the third band stacking register.
 - When a fourth frequency and operating mode are selected on a band, the first register set in step ①, is over written.

Frequency setting

The transceiver has several tuning methods for convenient frequency tuning.

◇ Tuning with the tuning dial

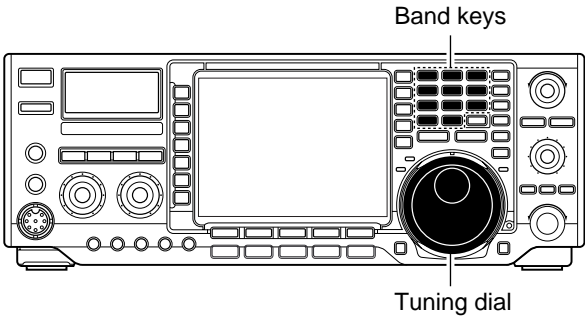

- ① Push the desired band key on the keypad 1–3 times.
 - 3 different frequencies can be selected on each band with the band key. (See previous page “Using the band stacking register.”)

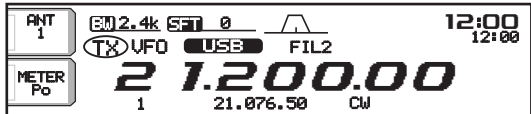

- ② Rotate the tuning dial to set the desired frequency.

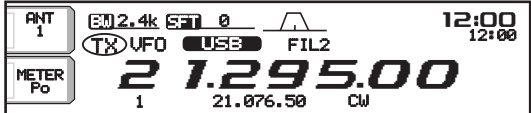

If the dial lock function is activated, the lock indicator lights, and the tuning dial does not function. In this case, push **[LOCK/SPEECH]** to deactivate the lock function. (p. 65)

◇ Direct frequency entry with the keypad

The transceiver has a keypad for direct frequency entry as described right.

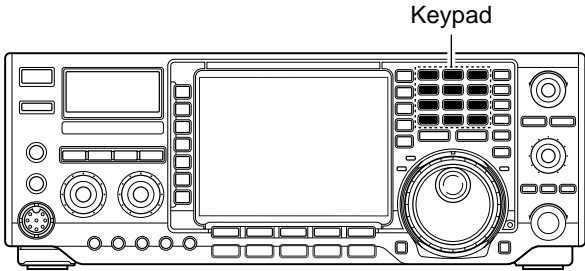

- ① Push **[(F-INP)ENT]**.
 - “**F-Inp**” appears.
- ② Input the desired frequency.
 - Push **[(GENE)•]** to input “• (decimal point)” between the MHz units and kHz units.
- ③ Push **[(F-INP)ENT]** to set the input frequency.
 - To cancel the input, push **[MAIN/SUB]** instead of **[(F-INP)ENT]**.

[EXAMPLES]

14.025 MHz

F-INP_ENT
1
4
•
0
2
5
F-INP_ENT

18.0725 MHz

F-INP_ENT
1
8
•
0
7
2
5
F-INP_ENT

706 kHz

F-INP_ENT
•
7
0
6
F-INP_ENT

5.100 MHz

F-INP_ENT
5
•
1
F-INP_ENT

7.000 MHz

F-INP_ENT
7
F-INP_ENT

21.280 → 21.245

F-INP_ENT
•
2
4
5
F-INP_ENT

◆ Quick tuning step

The operating frequency can be changed in kHz steps (0.1, 1, 5, 9, 10, 12.5, 20 or 25 kHz selectable) for quick tuning.

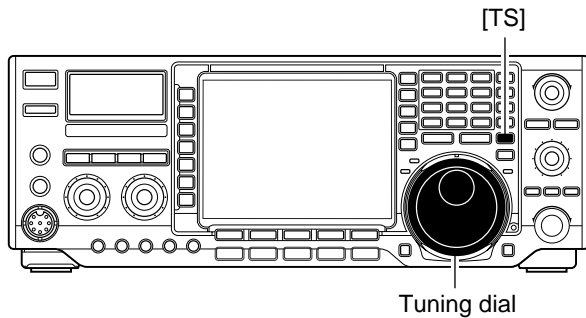

- ① Push **[TS]** momentarily to turn the quick tuning function ON.

• "▼" appears when the quick tuning function ON.

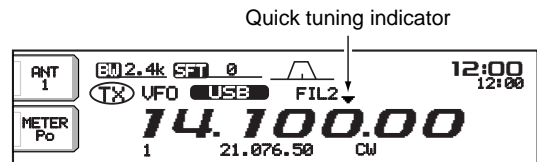

- ② Rotate the tuning dial to change the frequency in programmed kHz steps.
- ③ Push **[TS]** again to turn the quick tuning function OFF.
- ④ Rotate the tuning dial for normal tuning, if desired.

• "▼" disappears.

◆ Selecting "kHz" step

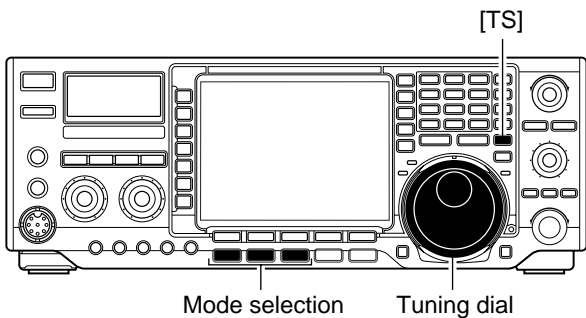

- ① Push **[TS]** momentarily to turn the quick tuning step ON.

• "▼" appears when the quick tuning function ON.

- ② Push **[TS]** for 1 sec. to enter the tuning step setting display.

• Selected tuning steps for all modes appear.

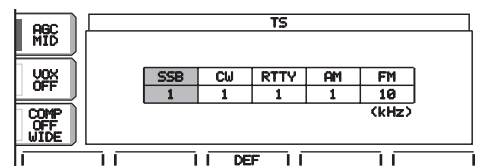

- ③ Select the desired operating mode.
- ④ Rotate the tuning dial to select the desired tuning step from 0.1, 1, 5, 9, 10, 12.5, 20 or 25 kHz.
- ⑤ Repeat steps ③ and ④ to select quick tuning steps for other modes, if desired.
- ⑥ Push **[EXIT/SET]** to exit the setting display.

• Push **[(F-3)DEF]** for 1 sec. to return to the default setting, if desired.

◆ Selecting 1 Hz step

The minimum tuning step of 1 Hz can be used for fine tuning.

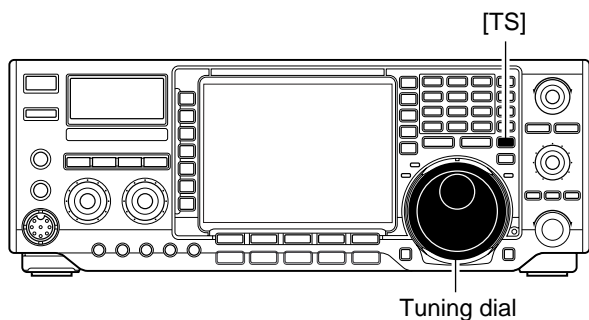

- ① Push **[TS]** to turn OFF the quick tuning step.
 - “▼” does not appear.
- ② Push **[TS]** for 1 sec. to turn the 1 Hz tuning step ON and OFF.
 - RIT and/or ΔTX also functions in 1 Hz tuning step when used.

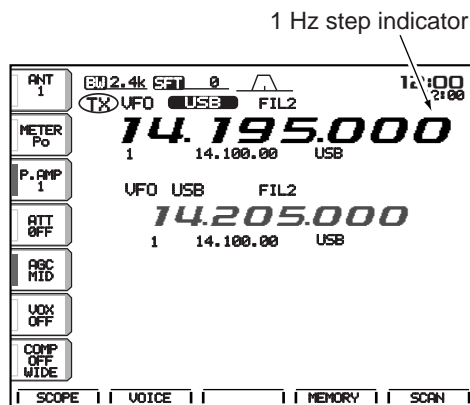

◆ 1/4 tuning function (SSB data/CW/RTTY only)

While operating in SSB data/CW/RTTY, the 1/4 tuning function is available for critical tuning. Dial rotation is reduced to 1/4 of normal when the 1/4 function is in use.

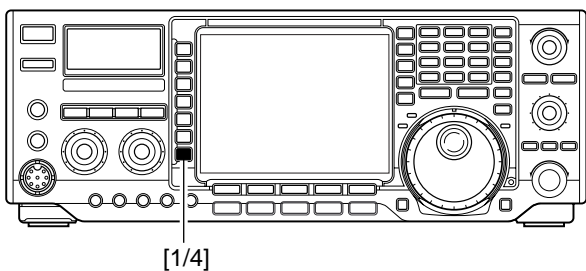

➔ Push **[1/4]** to toggle the 1/4 function ON and OFF.

1/4 tuning function OFF

1/4 tuning function ON



◆ Auto tuning step function

When rotating the tuning dial rapidly, the tuning speed accelerated automatically as selected.

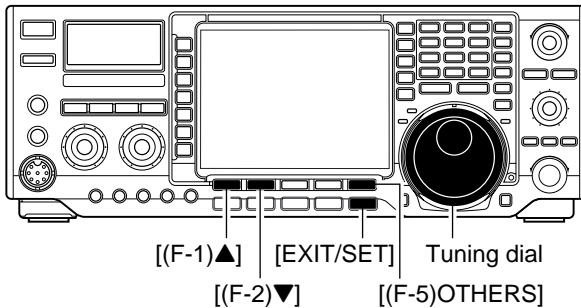

- ① Push **[EXIT/SET]** several times to close a multi-function screen, if necessary.
- ② Push **[EXIT/SET]** for 1 sec. to select the set mode menu screen.
- ③ Push **[(F-5)OTHERS]** to enter miscellaneous (others) set mode.
- ④ Push **[(F-1)▲]** or **[(F-2)▼]** to select "MAIN DIAL Auto TS."
- ⑤ Rotate the tuning dial to select the desired condition from high, low and OFF.
 - High: Approx. 5 times faster
 - Low: Approx. twice faster
 - OFF: Auto tuning step is turned OFF
- ⑥ Push **[EXIT/SET]** to exit the set mode.

OTHERS SET	
AGC MID	MemoPad Numbers OFF
BK-IN OFF	MAIN DIAL Auto TS HIGH
1/4 OFF	MIC UP/Down Speed HIGH
	Quick RIT/dTX Clear OFF
	SSB/CW Synchronous Tuning OFF
	CW Normal Side LSB
	External Keypad Auto
	DEF
	WIDE

◆ Band edge warning beep

When selecting a frequency, that lies outside of a band's specified frequency range, a warning beep sounds.

This function can be turned OFF in set mode, if desired.

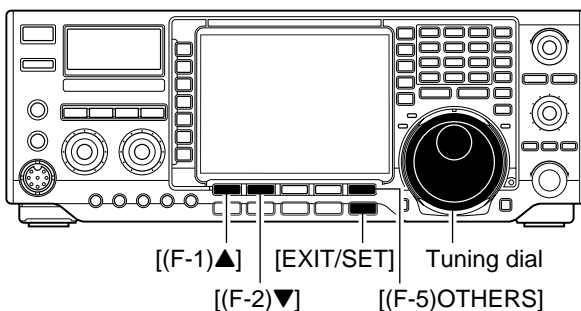

- ① Push **[EXIT/SET]** several times to close a multi-function screen, if necessary.
- ② Push **[EXIT/SET]** for 1 sec. to select the set mode menu screen.
- ③ Push **[(F-5)OTHERS]** to enter miscellaneous (others) set mode.
- ④ Push **[(F-1)▲]** or **[(F-2)▼]** to select "Beep (Band Edge)."
- ⑤ Rotate the tuning dial to turn the band edge warning beep ON and OFF.
- ⑥ Push **[EXIT/SET]** to exit the set mode.

OTHERS SET	
AGC MID	Beep (Confirmation) ON
BK-IN OFF	Beep (Band Edge) ON
1/4 OFF	RF/SQL Control RF+SQL
	Quick Dualwatch ON
	Quick SPLIT ON
	FM SPLIT Offset (HF) -0.100MHz
	FM SPLIT Offset (50M) -0.100MHz
	DEF
	WIDE

■ Operating mode selection

SSB (LSB/USB), SSB data (LSB-D/USB-D), CW, CW reverse (CW-R), RTTY, RTTY reverse (RTTY-R), AM, AM data (AM-D), FM and FM data (FM-D) are available in the IC-756PROIII. Select the desired operation mode as follows.

To select a mode of operation, push the desired mode switch momentarily. Push the switch again to toggle between USB and LSB, CW/CW-R and RTTY/RTTY-R, AM and FM, if necessary. Push the switch for 1 sec. to toggle between CW and CW-R, RTTY and RTTY-R, or to select data mode, if necessary.

See the diagram below left for the order of selection.

Microphone signals are muted when data mode is selected.

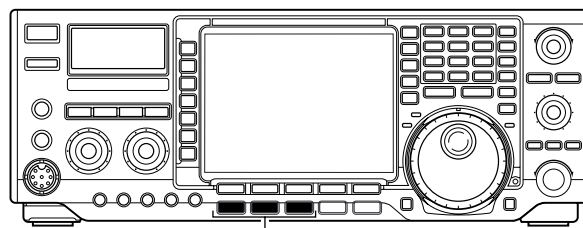
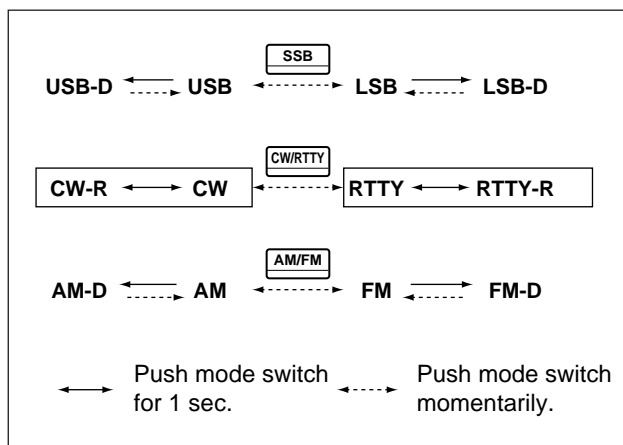

Mode selection

• Selecting SSB mode

- ➔ Push **[SSB]** to select USB or LSB.
 - USB is selected first when above 10 MHz; or LSB is selected first when below 10 MHz operation.
 - After USB or LSB is selected, push **[SSB]** to toggle between USB and LSB.
 - After USB or LSB is selected, push **[SSB]** for 1 sec. to select USB-D or LSB-D mode, respectively.

• Selecting CW/RTTY mode

- ➔ Push **[CW/RTTY]** to select CW or RTTY.
 - After CW or RTTY is selected, push **[CW/RTTY]** to toggle between CW and RTTY.
 - After CW or RTTY is selected, push **[CW/RTTY]** for 1 sec. to toggle between CW and CW reverse, or, RTTY and RTTY reverse mode, respectively.

• Selecting AM/FM mode

- ➔ Push **[AM/FM]** to select AM or FM.
 - After AM or FM is selected, push **[AM/FM]** to toggle between AM and FM.
 - After AM or FM is selected, push **[AM/FM]** for 1 sec. to select AM-D or FM-D mode, respectively.

■ Volume setting

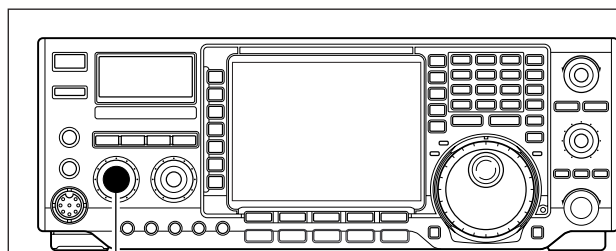

[AF]

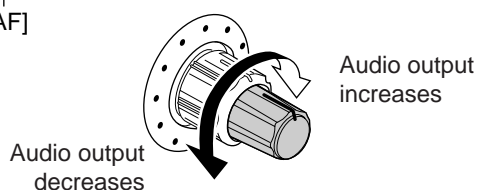

- ➔ Rotate **[AF]** control clockwise to increase; counter-clockwise to decrease the audio output level.
 - Set a suitable audio level.

■ Squelch and receive (RF) sensitivity

Adjusts the RF gain and squelch threshold level. The squelch removes noise output from the speaker (closed position) when no signal is received.

- The squelch is particularly effective for FM. It is also available for other modes.
- 12 to 1 o'clock position is recommended for any setting of the **[RF/SQL]** control.
- The control can be set as 'Auto' (RF gain control in SSB, CW and RTTY; squelch control in AM and FM) or squelch control (RF gain is fixed at maximum) in set mode as follows. (p. 99)

SET MODE	OPERATION
RF+SQL (default)	Can be used in all modes. Functions as noise squelch or S-meter squelch in AM and FM modes; S-meter squelch only in other modes.
SQL	Operates as a squelch control. • RF gain is fixed at maximum sensitivity.
AUTO	Operates as an RF gain control in SSB, CW and RTTY modes. • Squelch is fixed open. Operates as a squelch control in AM and FM modes. • RF gain is fixed at maximum sensitivity.

Adjusting RF gain (Receive sensitivity)

Normally, **[RF/SQL]** is set to the 11 o'clock position. Rotate **[RF/SQL]** to the 11 o'clock position for maximum sensitivity.

- Rotating counterclockwise from the maximum position reduces sensitivity.
- The S-meter indicates receive sensitivity.

Adjusting squelch (Removing non-signal noise)

Rotate **[RF/SQL]** clockwise when receiving no signal, until the noise just disappears.

- **[RX]** indicator light goes out.
- Rotating **[RF/SQL]** past the threshold point invokes the S-meter squelch— this allows you to set a minimum signal level needed to open the squelch.

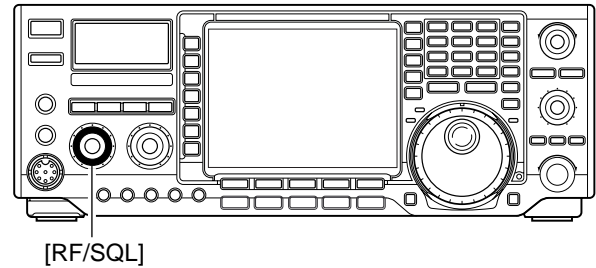

• When setting as RF gain/squelch control

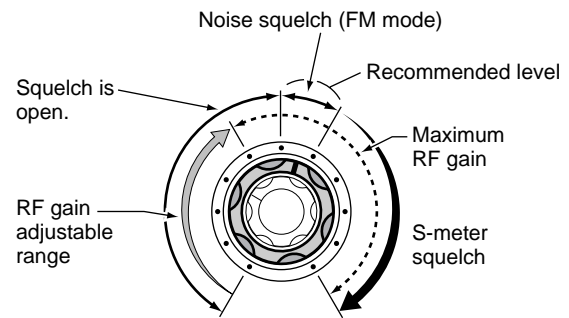

• When functioning as RF gain control (Squelch is fixed open; SSB, CW, RTTY only)

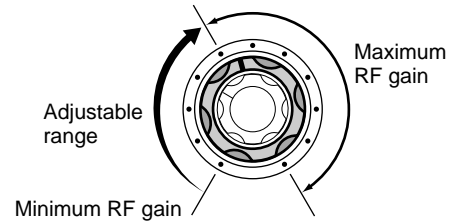

• When functioning as squelch control (RF gain is fixed at maximum.)

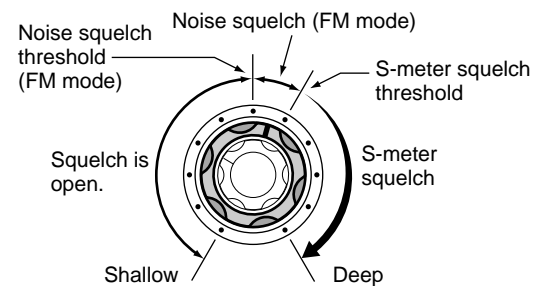

While rotating the RF gain control, noise may be heard. This comes from the DSP unit and does not indicate an equipment malfunction.

Meter function

The transceiver has 4 transmit meter functions for your convenience. Select the desired meter with the [METER] switch.

Analog transmit meter

➔ Push [METER] to select RF power (Po), SWR, ALC or compression level (COMP).

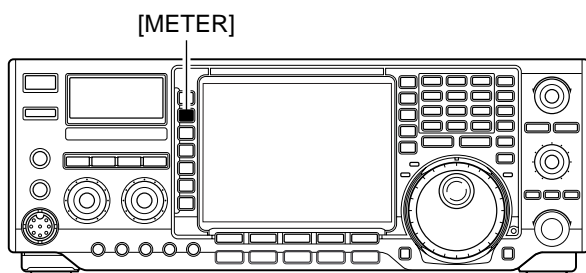

DISPLAY INDICATION	MEASUREMENT
Po	Indicates the relative RF output power in %.
SWR	Indicates the SWR over the transmission line.
ALC	Indicates the ALC level. When the meter movement shows the input signal level exceeds the allowable level, the ALC limits the RF power. In such cases, reduce the [MIC GAIN] control.
COMP	Indicates the compression level when the speech compressor is in use.

In addition, the transceiver can display the multi-function digital meter in the LCD display, which displays all transmit meters simultaneously.

Multi-function digital meter

- Push [METER] for 1 sec. to turn the multi-function digital meter ON.
- Push [(F-1)P-HOLD] to toggle the peak level hold function ON or OFF.
 - “P-HOLD” appears on the window title when the peak level hold function is turned ON.

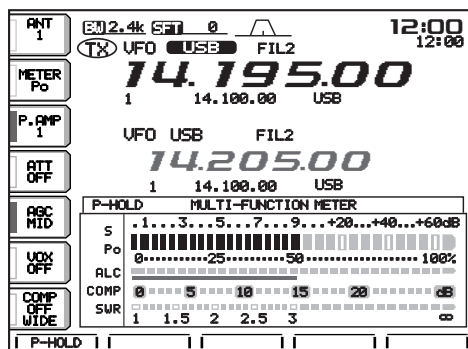

- Push [METER] for 1 sec. or push [EXIT/SET] to turn the multi-function digital meter OFF.

SWR reading

The SWR meter indicates the SWR over the transmission line in all modes.

- Push [TUNER] to turn the antenna tuner OFF.
- Push [METER] several times to select the Po meter.
- Push [CW/RTTY] once or twice to select RTTY mode.
- Push [TRANSMIT].
- Rotate [RF POWER] clockwise past the 12 o'clock position for more than 30 W output power (30%).
- Push [METER] once to select the SWR meter as the transmit meter.
- Read the SWR on the SWR meter.

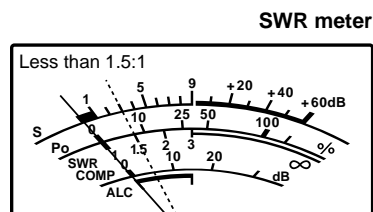

▨ The built-in antenna tuner matches the transmitter to the antenna when the SWR is lower than 3 : 1.

Basic transmit operation

Before transmitting, monitor your selected operating frequency to make sure transmitting won't cause interference to other stations on the same frequency. It's good Amateur practice to listen first, and then, even if nothing is heard, ask "is the frequency in use" once or twice, before you being operating on that frequency.

Transmitting

Before transmitting, monitor your selected operating frequency to make sure transmitting won't cause interference to other stations on the same frequency.

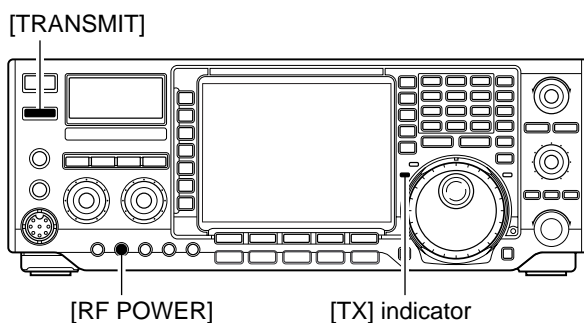

- ① Push **[TRANSMIT]** or **[PTT]** (microphone) to transmit.
 - The **[TX]** indicator lights red.
- ② Push **[TRANSMIT]** again or release **[PTT]** (microphone) to return to receive.

Adjusting the transmit output power

➔ Rotate **[RF POWER]**.

- Adjustable range: 5 W to 100 W
(AM mode: 5 W to 40 W)

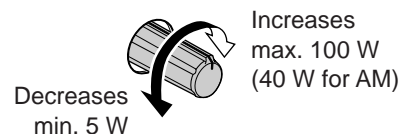

Microphone gain adjustment

Before transmitting, monitor your selected operating frequency to make sure transmitting won't cause interference to other stations on the same frequency.

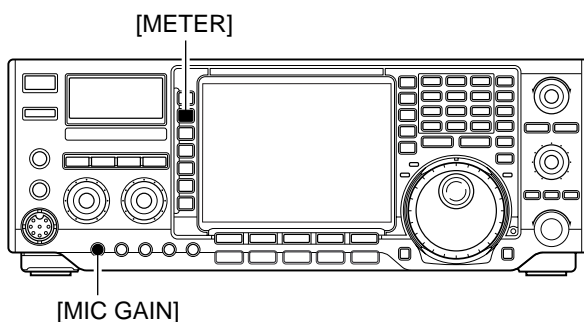

- ① Push **[METER]** to select the ALC meter.
- ② Push **[PTT]** (microphone) to transmit.
 - Talk into the microphone at your normal voice level.
- ③ While talking into the microphone, rotate **[MIC GAIN]** so that the ALC meter reading doesn't go outside the ALC zone.

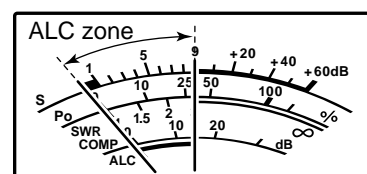

- ④ Release **[PTT]** (microphone) to return to receive.

In addition, the transceiver can display the multi-function digital meter in the LCD display, which displays all transmit meters simultaneously.

■ Operating SSB

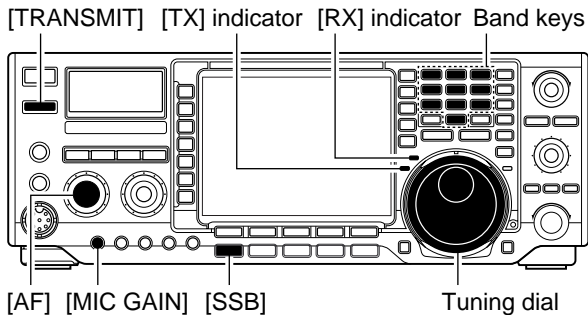

- ① Push a band key to select the desired band.
- ② Push **[SSB]** to select LSB or USB.
 - “LSB” or “USB” appears.
 - Below 10 MHz LSB is automatically selected; above 10 MHz USB is automatically selected.
- ③ Rotate the tuning dial to tune a desired signal.
 - The S-meter indicates received signal strength when signal is received.
- ④ Rotate **[AF]** to set audio to a comfortable listening level.
- ⑤ Push **[TRANSMIT]** or **[PTT]** (microphone) to transmit.
 - The TX indicator lights red.
- ⑥ Speak into the microphone at your normal voice level.
 - Adjust the microphone gain with **[MIC GAIN]** at this step, if necessary.
- ⑦ Push **[TRANSMIT]** or release **[PTT]** (microphone) to return to receive.

◇ Convenient functions for receive

• Preamp (p. 57)

- ➔ Push **[P.AMP]** several times to set the preamp OFF, preamp 1 ON or preamp 2 ON.
 - “P.AMP1” or “P.AMP2” appears when the preamp 1 or preamp 2 is set to ON, respectively. (depending on operating frequency band)

• Attenuator (p. 57)

- ➔ Push **[ATT]** several times to set the attenuator in 6 dB steps.
 - “ATT” and attenuation level appear when the attenuator is set to ON.

• Noise blanker (p. 64)

- ➔ Push **[NB]** switch to turn the noise blanker ON and OFF.
 - Noise blanker indicator (in **[NB]** switch) lights when the noise blanker is set to ON.
- ➔ Push **[NB]** for 1 sec. to enter the noise blanker level set mode, then rotate the tuning dial to adjust the threshold level.

• Twin PBT (passband tuning) (p. 60)

- ➔ Rotate **[TWIN PBT]** controls (inner/outer).
 - Push **[PBT CLR]** to clear the settings.

• Noise reduction (p. 65)

- ➔ Push **[NR]** switch to turn the noise reduction ON and OFF.
 - Rotate **[NR]** control to adjust the noise reduction level.
 - Noise reduction indicator (in **[NR]** switch) lights when the noise reduction is set to ON.

• Notch filter (p. 64)

- ➔ Push **[NOTCH]** switch to turn the auto or manual notch function ON and OFF.
 - Rotate **[NOTCH]** control to set the attenuating frequency for manual notch operation.
 - Notch indicator (in **[NOTCH]** switch) lights when either the auto or manual notch is set to ON.

• AGC (auto gain control) (p. 59)

- ➔ Push **[AGC]** switch several times to select AGC FAST, AGC MID or AGC SLOW.
- ➔ Push **[AGC]** for 1 sec. to enter the AGC set mode.
 - Rotate the tuning dial to adjust the time constant.

◇ Convenient functions for transmit

- | | |
|---|---|
| <ul style="list-style-type: none"> • Speech compressor (p. 68) <ul style="list-style-type: none"> ➤ Push [COMP] to turn the speech compressor ON and OFF. <ul style="list-style-type: none"> • Pushing [COMP] for 1 sec. to select the compression bandwidth from wide, middle and narrow. • Transmit quality monitor (p. 70) <ul style="list-style-type: none"> ➤ Push [MONITOR] to turn the monitor function ON and OFF. <ul style="list-style-type: none"> • Monitor indicator (in [MONITOR] switch) lights when the monitor function is set to ON. ➤ Push [EXIT/SET] for 1 sec. then [(F-1)LEVEL] to enter level set mode. Select the monitor level item with [(F-1)▲]/[(F-2)▼] then rotate the tuning dial to adjust the monitor gain. | <ul style="list-style-type: none"> • VOX (voice operated transmit) (p. 66) <ul style="list-style-type: none"> ➤ Push [VOX] to turn the VOX function ON and OFF. <ul style="list-style-type: none"> • “VOX ON” appears when the VOX function is set to ON. • Audio tone control (p. 95) <ul style="list-style-type: none"> ➤ Push [EXIT/SET] for 1 sec. then [(F-1)LEVEL] to enter level set mode. Select an item with [(F-1)▲]/[(F-2)▼] then rotate the tuning dial to adjust the audio tone. |
|---|---|

◇ About 5 MHz band operation (USA version only)

IC-756PROIII Tuning Frequency*	FCC Channel Center Frequency*
5.33050 MHz	5.33200 MHz
5.34650 MHz	5.34800 MHz
5.36650 MHz	5.36800 MHz
5.37150 MHz	5.37300 MHz
5.40350 MHz	5.40500 MHz

To assist you in operating the 5 MHz band correctly within the rules specified by the FCC, transmission is impossible on any 5 MHz band frequency other than the 5 frequencies indicated in the table above.

Operation on the 5 MHz band is allowed on 5 discrete frequencies and must adhere to the following:

- USB mode
- Maximum of 50 watts ERP (Effective Radiated Power)
- 2.8 kHz bandwidth

It is the operator's responsibility to set all controls so that the transmission in this band meets the stringent conditions under which we may use these frequencies.

NOTE: We recommend that you store these frequencies, mode and filter settings into the memory channel for easy recall.

*The channel center frequencies that are specified by the FCC, show the center frequency of their passband. However, the IC-756PROIII displays carrier point frequency, so set 1.5 kHz below from FCC channel center frequency.

■ Operating CW

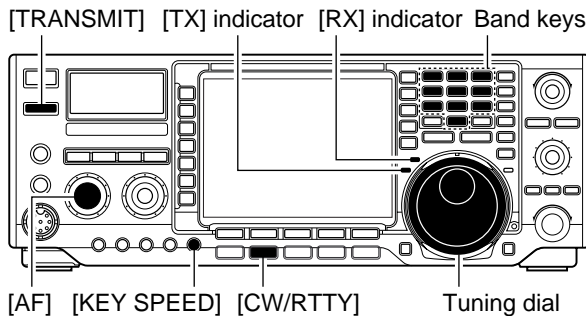

- ① Push a band key to select the desired band.
- ② Push **[CW/RTTY]** to select CW.
 - After CW mode is selected, push **[CW/RTTY]** for 1 sec. to toggle between CW and CW-R modes.
 - “CW” or “CW-R” appears.
- ③ Rotate the tuning dial to simultaneously tune a desired signal and its side tone.
 - The S-meter indicates received signal strength when signal is received.
- ④ Rotate **[AF]** to set audio to a comfortable listening level.
- ⑤ Push **[TRANSMIT]** to transmit.
 - The TX indicator lights red.
- ⑥ Use the electric keyer or paddle to key your CW signals.
 - The power meter indicates transmitted CW output power.
- ⑦ Adjust CW speed with **[KEY SPEED]**.
 - Adjustable within 6-60 WPM.
- ⑧ Push **[TRANSMIT]** to return to receive.

◇ Convenient functions for receive

- **Preamp** (p. 57)
 - Push **[P.AMP]** several times to set the preamp OFF, preamp 1 ON or preamp 2 ON.
 - “P.AMP1” or “P.AMP2” appears when the preamp 1 or preamp 2 is set to ON, respectively. (depending on operating frequency band)
- **Attenuator** (p. 57)
 - Push **[ATT]** several times to set the attenuator in 6 dB steps.
 - “ATT” and attenuation level appear when the attenuator is set to ON.
- **Noise blanker** (p. 64)
 - Push **[NB]** switch to turn the noise blanker ON and OFF.
 - Noise blanker indicator (in **[NB]** switch) lights when the noise blanker is set to ON.
 - Push **[NB]** for 1 sec. to enter the noise blanker level set mode, then rotate the tuning dial to adjust the threshold level.
- **Twin PBT (passband tuning)** (p. 60)
 - Rotate **[TWIN PBT]** controls (inner/outer).
 - Push **[PBT CLR]** to clear the settings.
- **Noise reduction** (p. 65)
 - Push **[NR]** switch to turn the noise reduction ON and OFF.
 - Rotate **[NR]** control to adjust the noise reduction level.
 - Noise reduction indicator (in **[NR]** switch) lights when the noise reduction is set to ON.
- **Notch filter** (p. 64)
 - Push **[NOTCH]** switch to turn the manual notch function ON and OFF.
 - Rotate **[NOTCH]** control to set the attenuating frequency for manual notch operation.
 - Notch indicator (in **[NOTCH]** switch) lights when the manual notch is set to ON.
- **AGC (auto gain control)** (p. 59)
 - Push **[AGC]** switch several times to select AGC FAST, AGC MID or AGC SLOW.
 - Push **[AGC]** for 1 sec. to enter the AGC set mode.
 - Rotate the tuning dial to adjust the time constant.
- **1/4 function** (p. 27)
 - Push **[1/4]** to turn the 1/4 function ON and OFF.

◇ Convenient functions for transmit

• Break-in function (p. 67)

- Push **[BK-IN]** several times to select the break-in OFF, semi break-in and full break-in.
 - “BK-IN SEMI” or “BK-IN FULL” appears when the semi break-in or full break-in function is set to ON, respectively.

◇ About CW reverse mode

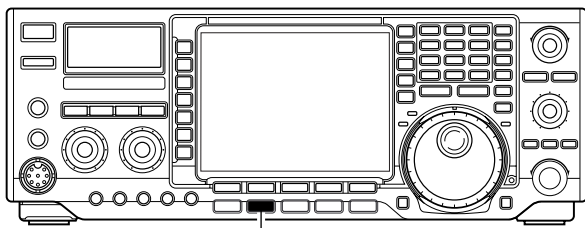

[CW/RTTY]

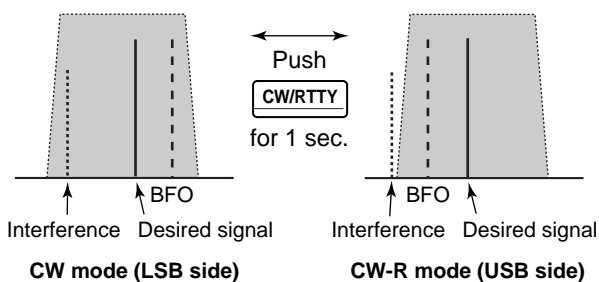

CW-R (CW Reverse) mode receives CW signals with a reverse side CW carrier point like that of LSB and USB modes.

Use when interfering signals are near a desired signal and you want to change the interference tone.

- ① Push **[CW/RTTY]** once or twice to select CW mode.
- ② Push **[CW/RTTY]** for 1 sec. to select CW or CW-R mode.
 - Check the interfering tone.

◇ CW side tone function

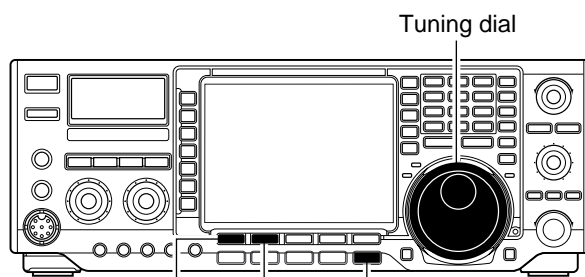

[(F-1)▲] [(F-2)▼] [EXIT/SET]

When the transceiver is in the receive condition (and the break-in function is OFF— p. 67) you can listen to the tone of your CW signal without actually transmitting.

This allows you to match your transmit signal exactly to another station's. This also convenient for CW practice.

- Push **[EXIT/SET]** for 1 sec. then **[(F-1)▲]** to enter level set mode. Select an item with **[(F-1)▲]/[(F-2)▼]** then rotate the tuning dial to adjust the side tone level.

◇ About CW pitch control

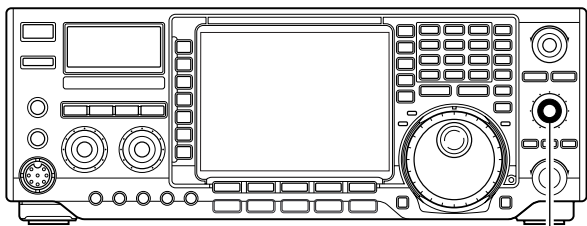

[CW PITCH]

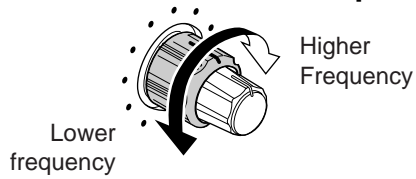

The received CW audio pitch and monitored CW audio can be adjusted to suit your preference (300 to 900 Hz in 25 Hz steps) without changing the operating frequency.

- ➔ Rotate **[CW PITCH]** to suit your preference.
 - Adjustable within 300 to 900 Hz in 25 Hz steps.

▨ The filter set mode screen graphically displays the CW pitch operations. (See at left.)

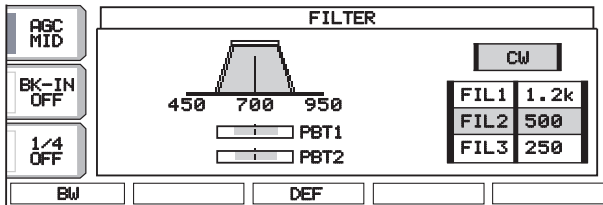

Electronic CW keyer

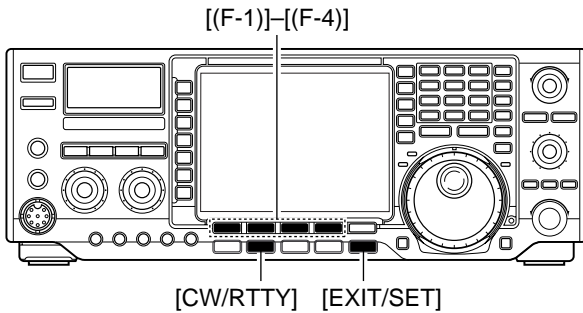

The IC-756PROIII has a number of convenient functions for the electronic keyer that can be accessed from the memory keyer menu.

- ① Push [EXIT/SET] several times, if necessary.
- ② Push [CW/RTTY] to select CW mode.
- ③ Push [(F-3)KEYER] then [EXIT/SET] to select memory keyer menu screen.
- ④ Push one of the multi-function keys [(F-1) to (F-4)] to select the desired menu. See the diagram below.
 - Push [EXIT/SET] to return to the previous indication.

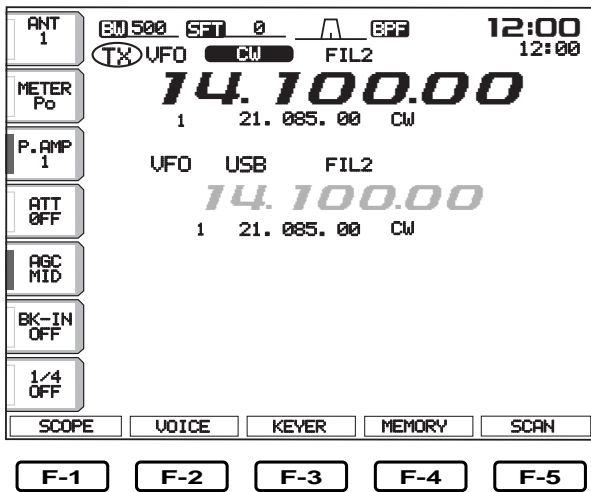

• Memory keyer edit screen

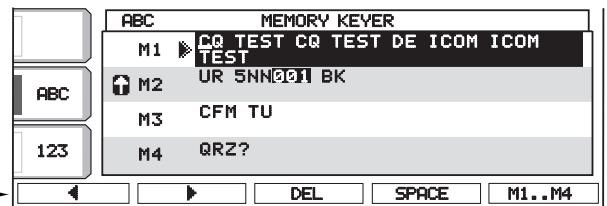

• Memory keyer send screen

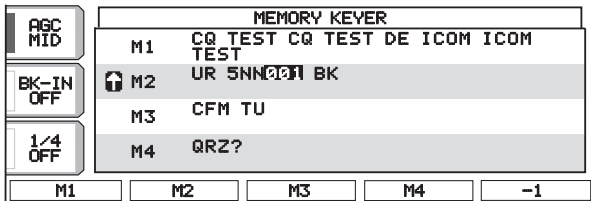

• Contest number set mode

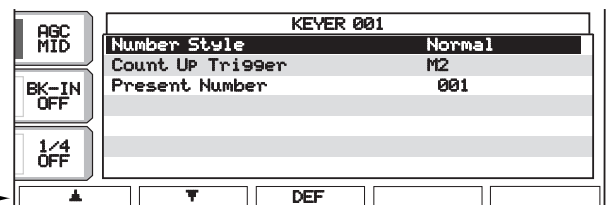

• Memory keyer menu screen

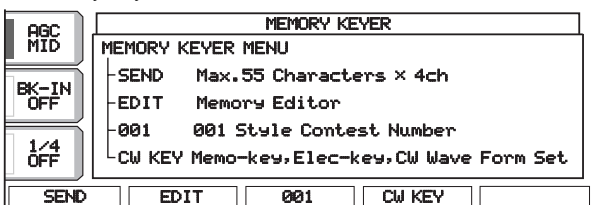

• Keyer set mode screen

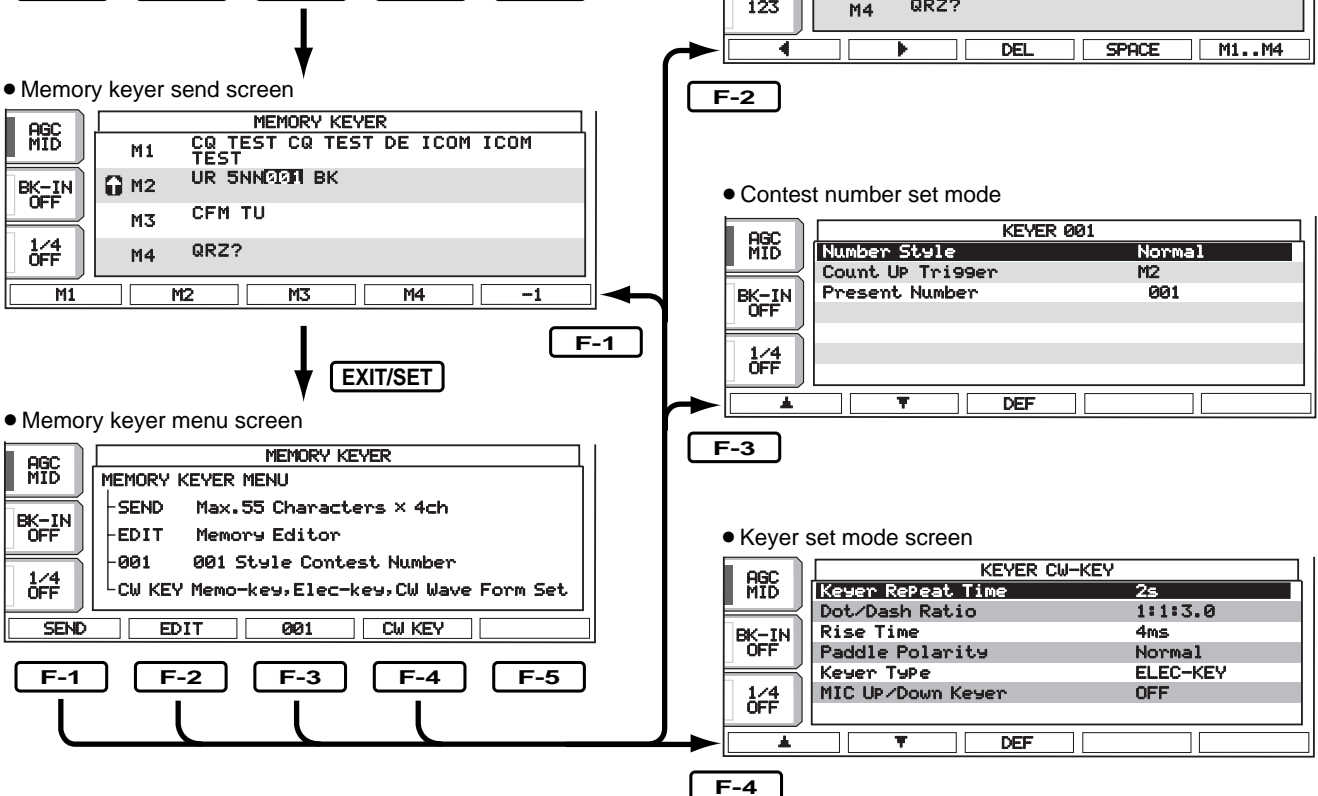

◇ Memory keyer send screen

Pre-set characters can be sent using the keyer send menu. Contents of the memory keyer are set using the edit menu.

[TRANSMIT] [(F-1)M1]–[(F-4)M4]

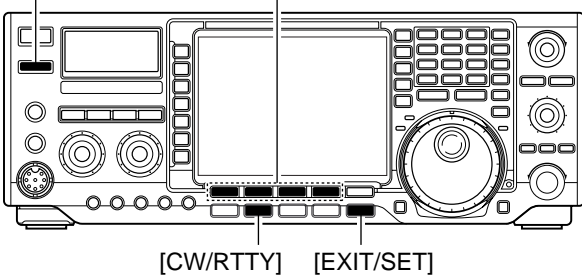

ABC MTD	MEMORY KEYS				
BK-IN OFF	M1	CQ TEST CQ TEST DE ICOM ICOM TEST			
1/4 OFF	M2	UR 5NN001 BK			
	M3	CFM TU			
	M4	QRZ?			
	M1	M2	M3	M4	-1

• Transmitting

- ① Push [EXIT/SET] several times, if necessary.
- ② Push [CW/RTTY] to select CW mode.
- ③ Push [(F-3)KEYER] to select the memory keyer screen.
- ④ Push [TRANSMIT] to set the transceiver to transmit, or set the break-in function ON (p.67).
- ⑤ Push [(F-1)M1] – [(F-4)M4] momentarily to transmit the contents one time; push these keys for 1 sec. to transmit the contents repeatedly.
 - “M1”–“M4” are highlighted while transmitting.
 - “” appears while transmitting repeatedly.
 - Set the repeat interval of the memory keyer to 1–60 sec. (1 sec. steps). See p. 42 for keyer set mode.
 - To count down the contact number, push [(F-5)–1].

/// For your information

When an external keypad is connected to the pin 3 and pin 7 of the [MIC] connector, the programmed contents, M1–M4, can be transmitted without opening the memory keyer screen.
See page 104 for details.

- ⑥ Push [EXIT/SET] twice to exit the memory keyer screen.

◇ Editing a memory keyer

The contents of the memory keyer memories can be set using the memory keyer edit menu. The memory keyer can memorize and re-transmit 4 CW key codes for often-used CW sentences, contest number, etc. Total capacity of the memory keyer is 70 characters per memory channel.

[123]/[etc] [ABC] [(F-3)DEL] [(F-4)SPACE]

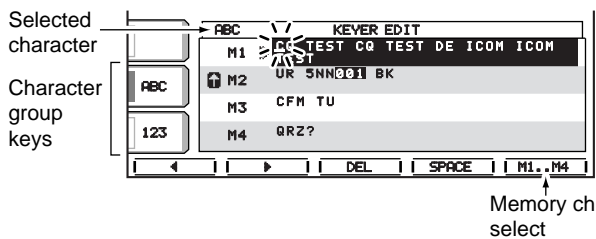
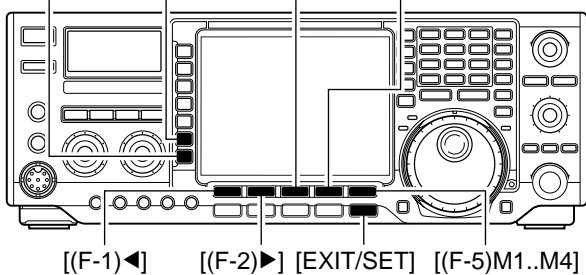

• Pre-programmed contents

CH	Contents
M1	CQ TEST CQ TEST DE ICOM ICOM TEST
M2	UR 5NN* BK
M3	CFM TU
M4	QRZ?

• Programming contents

- ① Push **[EXIT/SET]** several times, if necessary.
- ② Push **[CW/RTTY]** to select CW mode.
- ③ Push **[(F-3)KEYER]** then **[EXIT/SET]** to select keyer set mode.
- ④ Push **[(F-2)EDIT]** to enter the keyer edit screen.
- ⑤ Push **[(F-5)M1..M4]** several times to select the desired keyer memory channel.
- ⑥ Select the desired character group by pushing the character group keys (**[ABC]**, **[123]** or **[etc]**) several times.

- **[etc]** appears when **[123]** is pushed when "123" character group is selected.
- Selectable characters (with the tuning dial);

Key selection	Editable characters
[ABC]	A to Z (capital letters)
[123]	0 to 9 (numbers)
[etc]	/ ? ^ . , @ *

NOTE:

- "A" is used to transmit a following word with no space such as AR. Put "A" before a text string such as ^AR, and the string "AR" is sent with no space.
- "*" is used to insert the CW contest number. The contest number automatically increments by 1. This function is only available for one memory keyer channel at a time. Memory keyer channel M2 used "*" by default.

- ⑦ Select the desired character by rotating the tuning dial or by pushing the band key for number input.
 - Push **[(F-1)◀]** or **[(F-2)▶]** for cursor movement.
 - Push **[(F-3)DEL]** to delete the selected character.
 - Push **[(F-4)SPACE]** to input a space.
 - "*" is for contact numbers and can be input for the count up trigger channel ("A" appears).
- ⑧ Repeat step ⑦ until the desired contents are input.
- ⑨ Push **[(F-5)M1..M4]** to select the next memory channel and repeat step ⑦ for character input, if desired.
- ⑩ Push **[EXIT/SET]** twice to exit the keyer set mode.

◆ Contest number set mode

This menu is used to set the contest (serial) number and count up trigger, etc.

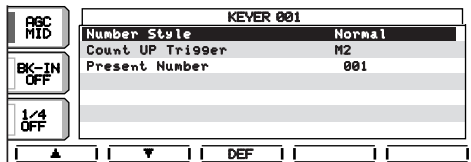
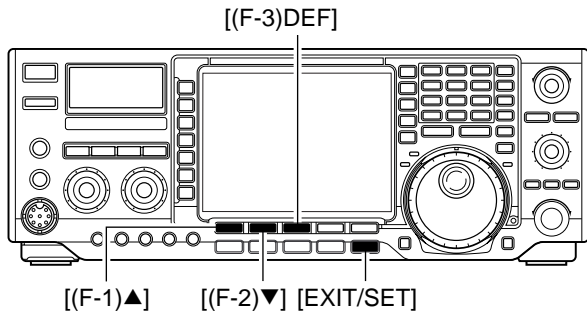

• Setting the contact (serial) number

Contact number can be automatically transmitted from one of the memory keyer channels. The Morse cut numbers can be used as the contact numbers. The maximum number for contact numbers is 9999.

- ① Push **[EXIT/SET]** several times, if necessary.
- ② Push **[CW/RTTY]** to select CW mode.
- ③ Push **[(F-3)KEYER]** then **[EXIT/SET]** to select keyer set mode.
- ④ Push **[(F-3)001]** to select contest number set mode.
- ⑤ Push **[(F-1)▲]** or **[(F-2)▼]** to select the desired set item.
 - Push **[(F-3)DEF]** for 1 sec. to select the default condition or value.
- ⑥ Push **[EXIT/SET]** twice to exit the keyer set mode.

Number Style (Number style)

This item sets the numbering system used for contest (serial) numbers— normal or morse cut numbers.

- Normal : Does not use morse cut number (default)
- 190→ANO : Sets 1 as A, 9 as N and 0 as O.
- 190→ANT : Sets 1 as A, 9 as N and 0 as T.
- 90→ NT : Sets 9 as N and 0 as O.
- 90→ NT : Sets 9 as N and 0 as T.

Count UP Trigger (Count up trigger)

This selects which of the three memory slots will have the contest serial number exchange. The count up trigger allows the serial number automatically incremented after each complete serial number exchange is sent.

- M1, M2, M3 and M4 can be set. (default: M2)

Present Number (Present number)

This item shows the current number for the count up trigger channel set above.

- Rotate the tuning dial to change the number, or push **[(F-3)001CLR]** for 1sec. to reset the current number to 001.

◆ Keyer set mode

This set mode is used to set the CW side tone, memory keyer repeat time, dash weight, paddle specifications, keyer type, etc.

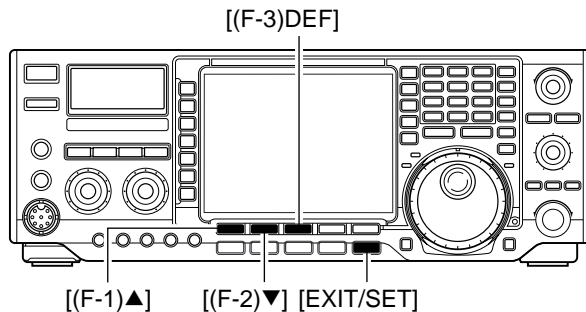

KEYER CW-KEY	
Keyer Repeat Time	2s
Dot/Dash Ratio	1:1:3.0
Rise Time	4ms
Paddle Polarity	Normal
Keyer Type	ELEC-KEY
MIC UP/Down Keyer	OFF

• Setting the electronic keyer

- ① Push **[EXIT/SET]** several times, if necessary.
- ② Push **[CW/RTTY]** to select CW mode.
- ③ Push **[(F-3)KEYER]** then **[EXIT/SET]** to select keyer set mode.
- ④ Push **[(F-4)CW KEY]** to select memory keyer set mode.
- ⑤ Push **[(F-1)▲]** or **[(F-2)▼]** to select the desired set item.
- ⑥ Set the desired condition using the tuning dial.
 - Push **[(F-3)DEF]** for 1 sec. to select a default condition or value.
- ⑦ Push **[EXIT/SET]** twice to normal screen.

Keyer Repeat Time

(Keyer repeat time)

When sending CW using the repeat timer, this item sets the time between transmission.

- 1 to 60 sec. in 1 sec. steps can be selected.
- Push **[(F-3)DEF]** for 1 sec. to select a default setting. (default: 2 sec.)

Dot/Dash Ratio (Dot/Dash ratio)

This item sets the dot/dash ratio.

Keying weight example: Morse code "K"

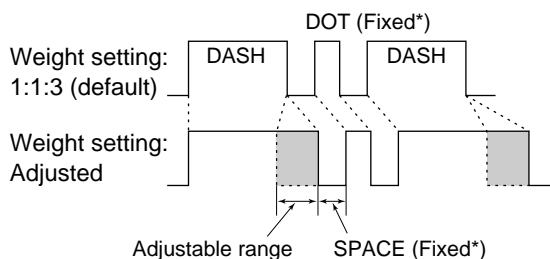

*SPACE and DOT length can be adjusted with **[KEY SPEED]** only.

- 1:1:2.8 to 1:1:4.5 can be set.
- Check the ratio with side tone in CW mode.
- Push **[(F-3)DEF]** for 1 sec. to select a default ratio of 1:1:3.0.

◇ **Keyer set mode (continued)**

Rise Time (Rise time)

This item sets the envelop time period which the out-put power becomes the set transmit power.

- 2, 4, 6, or 8 msec. can be selected.
- Push **[(F-3)DEF]** for 1 sec. to select a default setting. (default: 4 sec.)

• **About rise time**

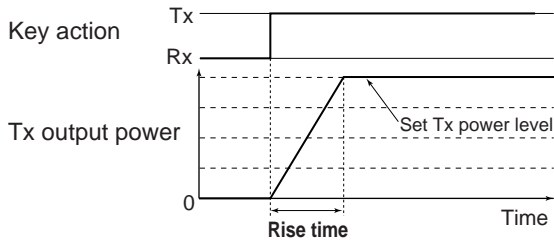

Paddle Polarity (Paddle polarity)

This item sets the paddle polarity.

- Normal and reverse poarity can be selected.
- Push **[(F-3)DEF]** for 1 sec. to select a default setting. (default: Normal)

Keyer Type (Keyer type)

This item selects the keyer type for **[ELEC-KEY]** con-connector on the front panel.

- ELEC-KEY, BUG-KEY and Straight key can be se-lected.
- Push **[(F-3)DEF]** for 1 sec. to select a default setting. (default: ELEC-KEY)

MIC UP/Down Keyer

(Microphone's **[UP]/[DN]** switches keyer)

This item allows you to set the microphone **[UP]/[DN]** switches to be used as a paddle.

- ON : **[UP]/[DN]** switches can be used for CW.
- OFF : **[UP]/[DN]** switches cannot be used for CW.
- Push **[(F-3)DEF]** for 1 sec. to select a default setting. (default: OFF)

NOTE: When "ON" is selected, the frequency and memory channel cnanot be changed using the **[UP]/[DN]** switches.

■ Operating RTTY (FSK)

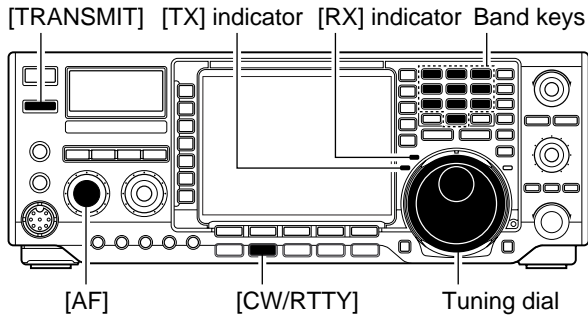

When using your RTTY terminal or TNC, consult the manual that comes with the RTTY terminal or TNC.

- ① Push a band key to select the desired band.
- ② Push **[CW/RTTY]** to select RTTY.
 - After RTTY mode is selected, push **[CW/RTTY]** for 1 sec. to toggle between RTTY and RTTY-R modes.
 - “RTTY” or “RTTY-R” appears.
- ③ Push **[(F-3)DECODE]** to display the decoder screen.
 - The IC-756PROIII has a Baudot decoder.
- ④ Rotate the tuning dial to simultaneously tune a desired signal.
 - The S-meter indicates received signal strength when signal is received.
- ⑤ Push **[TRANSMIT]** to transmit.
 - The TX indicator lights red.
- ⑥ Type from the connected PC’s keyboard to enter the contents that you want to transmit.
 - The text color will be changed when transmitted.
 - Press one of **[F-1]** to **[F-4]** to transmit the TX memory contents.
- ⑦ Push **[TRANSMIT]** to return to receive.

◇ Convenient functions for receive

- **Preamp** (p. 57)
 - ➔ Push **[P.AMP]** several times to set the preamp OFF, preamp 1 ON or preamp 2 ON.
 - “P.AMP1” or “P.AMP2” appears when the preamp 1 or preamp 2 is set to ON, respectively. (depending on operating frequency band)
- **Attenuator** (p. 57)
 - ➔ Push **[ATT]** several times to set the attenuator in 6 dB steps.
 - “ATT” and attenuation level appear when the attenuator is set to ON.
- **Noise blanker** (p. 64)
 - ➔ Push **[NB]** switch to turn the noise blanker ON and OFF.
 - Noise blanker indicator (in **[NB]** switch) lights when the noise blanker is set to ON.
 - ➔ Push **[NB]** for 1 sec. to enter the noise blanker level set mode, then rotate the tuning dial to adjust the threshold level.
- **Twin PBT (passband tuning)** (p. 60)
 - ➔ Rotate **[TWIN PBT]** controls (inner/outer).
 - Push **[PBT CLR]** to clear the settings.
- **Noise reduction** (p. 65)
 - ➔ Push **[NR]** switch to turn the noise reduction ON and OFF.
 - Rotate **[NR]** control to adjust the noise reduction level.
 - Noise reduction indicator (in **[NR]** switch) lights when the noise reduction is set to ON.
- **AGC (auto gain control)** (p. 59)
 - ➔ Push **[AGC]** switch several times to select AGC FAST, AGC MID or AGC SLOW.
 - ➔ Push **[AGC]** for 1 sec. to enter the AGC set mode.
 - Rotate the tuning dial to adjust the time constant.
- **1/4 function** (p. 27)
 - ➔ Push **[1/4]** to turn the 1/4 function ON and OFF.

◆ About RTTY reverse mode

Received characters are occasionally garbled when the receive signal is reversed between MARK and SPACE. This reversal can be caused by incorrect TNC connections, settings, commands, etc.

To receive a reversed RTTY signal correctly, select RTTY-R (RTTY Reverse) mode.

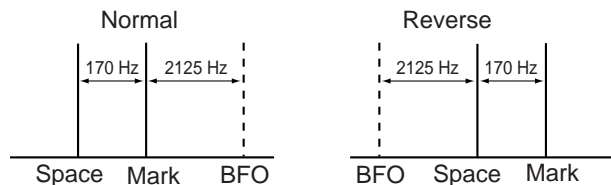

- ① Push **[CW/RTTY]** once or twice to select RTTY mode.
- ② Push **[CW/RTTY]** for 1 sec. to select RTTY or RTTY-R mode.
 - Check the receive signal.

◆ RTTY filter/Twin peak filter

The transceiver has 5 RTTY filters in addition to normal IF filters. The passband width can be selected from 1 kHz, 500 Hz, 350 Hz, 300 Hz and 250 Hz. When the RTTY filter is turned ON, the RTTY tuning meter can be used. (p. 47)

Moreover, the twin peak filter changes the receive frequency response by boosting 2 particular frequencies (2125 and 2295 Hz) for better copying of desired RTTY signals.

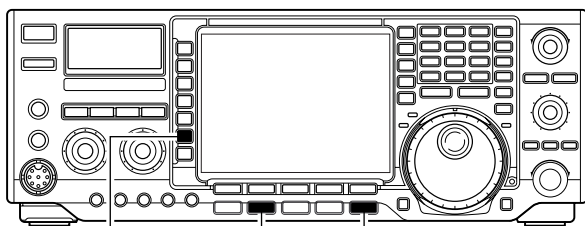

[RTTY FIL] [CW/RTTY] [EXIT/SET]

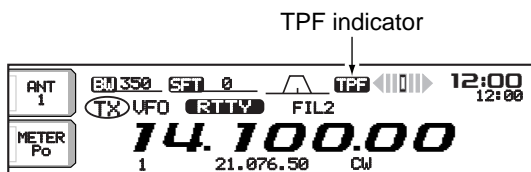

- ① Push **[CW/RTTY]** once or twice to select RTTY mode.
- ② Push **[RTTY FIL]** to turn the RTTY filter ON.
 - “TPF” appears when the twin peak filter is turned ON.

• RTTY filter selection

- ① Push **[EXIT/SET]** several times to close a multi-function screen, if necessary.
- ② Select RTTY mode.
- ③ Push **[RTTY FIL]** for 1 sec. to enter RTTY filter set mode.
- ④ Push **[(F-1)▲]** to select band width item.
- ⑤ Rotate the tuning dial to select the RTTY filter width from 1 kHz, 500 Hz, 350 Hz, 300 Hz and 250 Hz.
 - Push **[(F-3)DEF]** for 1 sec. to select a default value.
- ⑥ Push **[(F-2)▼]** to select twin peak filter item.
 - The received audio volume may become greater when the twin peak filter is turned ON.
- ⑦ Rotate the tuning dial to turn the twin peak filter function ON or OFF.
- ⑧ Push **[EXIT/SET]** to exit the RTTY filter set mode.

◆ Functions for the RTTY decoder indication

The transceiver has an RTTY decoder for Baudot (mark freq.: 2125 Hz, shift freq.: 170 Hz, 45 bps).

An external terminal unit (TU) or terminal node controller (TNC) is not necessary for receiving a Baudot signal.

- ① Push **[EXIT/SET]** several times to close a multi-function screen, if necessary.
- ② Push **[CW/RTTY]** to select RTTY mode.
- ③ Push **[(F-3)DECODE]** to turn the RTTY decoder ON.
 - RTTY decoder screen appears.

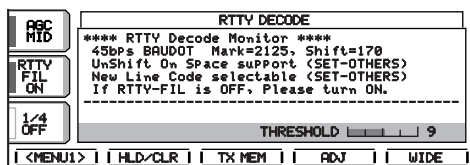

- ④ If the RTTY filter is turned OFF, push **[RTTY FIL]** to turn the function ON.
 - The RTTY decoder does not function when the RTTY filter is turned OFF.
- ⑤ Push **[(F-2)HOLD/CLR]** momentarily to freeze the current screen.
 - “HOLD” appears while the function is in use.
- ⑥ Push **[(F-5)WIDE]** to toggle the normal or wide screen space.

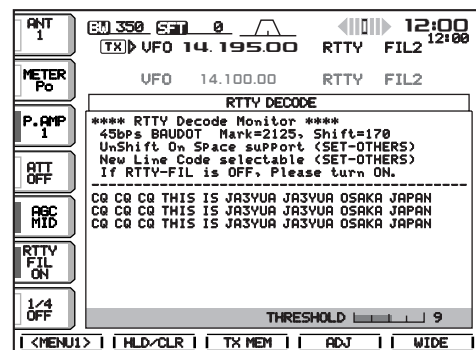

- ⑦ Push **[(F-2)HOLD/CLR]** for 1 sec. to clear the displayed characters.
- ⑧ Push **[EXIT/SET]** to exit the RTTY decoder screen.

◆ Setting the decoder threshold level

Adjust the RTTY decoder threshold level if some characters are displayed when no signal is received.

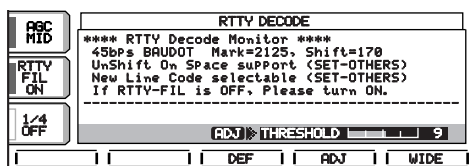

- ① Call up the RTTY decoder screen as described above.
- ② Push **[(F-4)ADJ]** to select the threshold level setting condition.
- ③ Rotate the tuning dial to adjust the RTTY decoder threshold level.
 - Push **[(F-3)DEF]** for 1 sec. to select the default condition.
- ④ Push **[EXIT/SET]** to exit the RTTY decoder screen.

▨ The UnShift On Space (USOS) function and new line code can be set in the RTTY set mode. (p. 49)

◇ RTTY memory transmission

Pre-set characters can be sent using the RTTY memory. Contents of the memory are set using the edit menu.

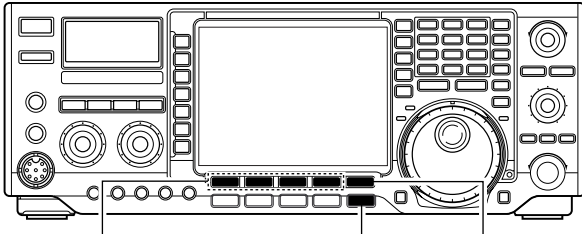

[(F-1)RT1]–[(F-4)RT4] [EXIT/SET] [(F-5)1-4/5-8]
[(F-1)RT5]–[(F-4)RT8]

- ① Push **[EXIT/SET]** several times to close a multi-function screen, if necessary.
- ② Push **[CW/RTTY]** to select RTTY mode.
- ③ Push **[(F-3)DECODE]** to turn the RTTY decoder ON.
- ④ Push **[(F-3)TX MEM]** to select RTTY memory screen.
- ⑤ Push **[(F-5)1-4/5-8]** to select memory bank then push one of the function keys **[(F-1)RT1]** to **[(F-4)RT4]** or **[(F-1)RT5]** to **[(F-4)RT8]**.
• The selected memory contents will be transmitted immediately.

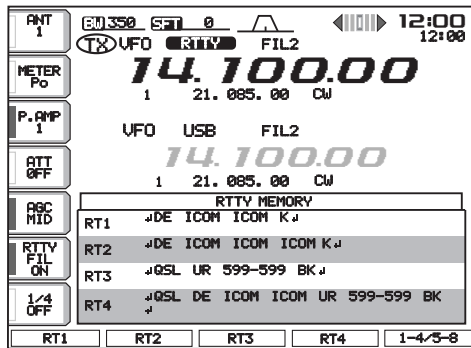

◇ RTTY tuning meter

The transceiver has an RTTY tuning indicator to be tuned correctly and easily.

The RTTY tuning meter is automatically displayed when the RTTY filter is turned ON.

- ① Push **[CW/RTTY]** to select RTTY mode.
- ② Push **[RTTY FIL]** to activate the RTTY filter and RTTY tuning meter.

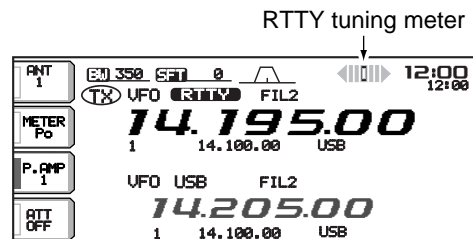

◇ Editing RTTY memory

The contents of the RTTY memories can be set using the memory edit menu. The memory can memorize and re-transmit 8 RTTY contents for often-used RTTY sentences. Total capacity of the memory is 70 characters per memory channel.

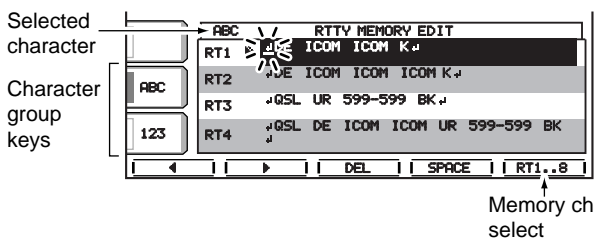
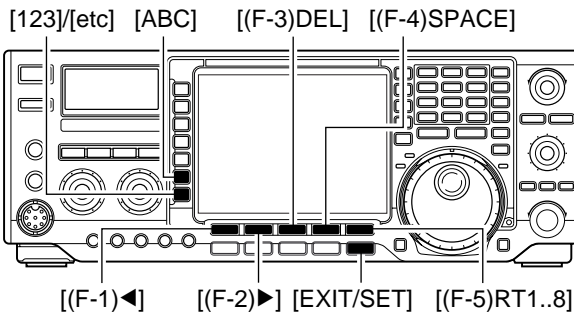

• Pre-programmed contents

CH	Contents
RT1	◀DE ICOM ICOM K▶
RT2	◀DE ICOM ICOM ICOM K▶
RT3	◀QSL UR 599-599 BK▶
RT4	◀QSL DE ICOM ICOM UR 599-599 BK▶
RT5	◀73 GL SK▶
RT6	◀CQ CQ CQ DE ICOM ICOM ICOM K▶
RT7	(blank)
RT8	(blank)

• Programming contents

- ① Push **[EXIT/SET]** several times, if necessary.
- ② Push **[CW/RTTY]** to select RTTY mode.
- ③ Push **[(F-3)DECODE]** then **[(F-1)MENU1]** to select the RTTY decode menu 2.
- ④ Push **[(F-2)EDIT]** to enter the RTTY memory edit screen.
- ⑤ Push **[(F-5)RT1..8]** several times to select the desired memory channel.
- ⑥ Select the desired character group by pushing the character group keys (**[ABC]**, **[123]** or **[etc]**) several times.
 - **[etc]** appears when **[123]** is pushed when "123" character group is selected.
 - Selectable characters (with the tuning dial);

Key selection	Editable characters
[ABC]	A to Z (capital letters)
[123]	0 to 9 (numbers)
[etc]	! \$ & ? " ' - / . , ; () ◀

- ⑦ Select the desired character by rotating the tuning dial or by pushing the band key for number input.
 - Push **[(F-1)◀]** or **[(F-2)▶]** for cursor movement.
 - Push **[(F-3)DEL]** to delete the selected character.
 - Push **[(F-4)SPACE]** to input a space.
- ⑧ Repeat step ⑦ until the desired contents are input.
- ⑨ Push **[(F-5)RT1..8]** to select the next memory channel and repeat step ⑦ for character input, if desired.
- ⑩ Push **[EXIT/SET]** to set the contents and exit RTTY memory edit screen.

◇ RTTY decoder set mode

This set mode is used to set the decode USOS function, etc.

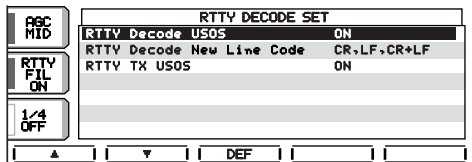
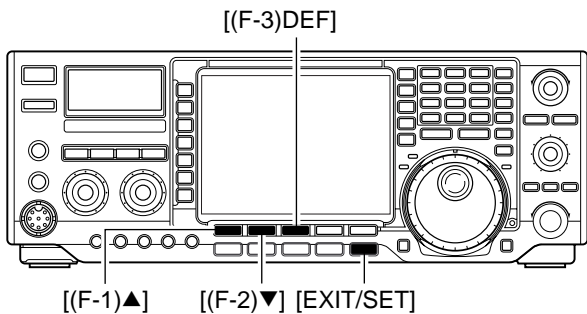

• Setting the contents

- ① Push [EXIT/SET] several times, if necessary.
- ② Push [CW/RTTY] to select RTTY mode.
- ③ Push [(F-3)DECODE] then [(F-1)MENU1] to select RTTY decode menu 2.
- ④ Push [(F-4)SET] to select RTTY decode set mode.
- ⑤ Push [(F-1)▲] or [(F-2)▼] to select the desired set item.
- ⑥ Set the desired condition using the tuning dial.
 - Push [(F-3)DEF] for 1 sec. to select a default condition or value.
- ⑦ Push [EXIT/SET] to exit from set mode.

RTTY Decode USOS

This item selects the USOS (UnShift On Space) function of the internal RTTY decoder.

ON	OFF
Decode as letter code (default)	Decode as character code

RTTY Decode New Line Code

This item selects the new line code of the internal RTTY decoder.

CR : Carriage Return
LF : Line Feed

CR,LF,CR+LF	CR+LF
CR, LF and CR+LF (default)	CR+LF only

RTTY TX USOS

This item selects the FIGS insertion even changing from LTRS to FIGS does not necessary when sending a numeral or symbol character after a space.

ON	OFF
Inserts FIGS (default)	Not insert FIGS

■ Operating AM

[TRANSMIT] [TX] indicator [RX] indicator Band keys

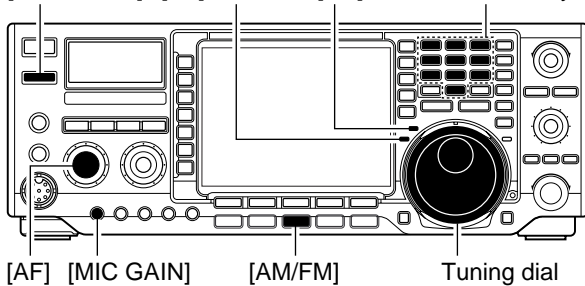

- ① Push a band key to select the desired band.
- ② Push **[AM/FM]** to select AM.
 - “AM” indicator appears.
 - After AM mode is selected, push **[AM/FM]** to toggle between AM and FM modes.
- ③ Rotate the tuning dial to tune a desired frequency.
 - The S-meter indicates received signal strength when signal is received.
- ④ Rotate **[AF]** to set audio to a comfortable listening level.
- ⑤ Push **[TRANSMIT]** or **[PTT]** (microphone) to transmit.
 - The TX indicator lights red.
- ⑥ Speak into the microphone at your normal voice level.
 - Adjust the microphone gain with **[MIC GAIN]** at this step, if necessary.
- ⑦ Push **[TRANSMIT]** or release **[PTT]** (microphone) to return to receive.

◇ Convenient functions for receive

- **Preamp** (p. 57)
 - ➔ Push **[P.AMP]** several times to set the preamp OFF, preamp 1 ON or preamp 2 ON.
 - “P.AMP1” or “P.AMP2” appears when the preamp 1 or preamp 2 is set to ON, respectively. (depending on operating frequency band)
- **Attenuator** (p. 57)
 - ➔ Push **[ATT]** several times to set the attenuator in 6 dB steps.
 - “ATT” and attenuation level appear when the attenuator is set to ON.
- **Twin PBT (passband tuning)** (p. 62)
 - ➔ Rotate **[TWIN PBT]** controls (inner/outer).
 - Push **[PBT CLR]** to clear the settings.
- **Noise reduction** (p. 65)
 - ➔ Push **[NR]** switch to turn the noise reduction ON and OFF.
 - Rotate **[NR]** control to adjust the noise reduction level.
 - Noise reduction indicator (in **[NR]** switch) lights when the noise reduction is set to ON.
- **Noise blanker** (p. 64)
 - ➔ Push **[NB]** switch to turn the noise blanker ON and OFF.
 - Noise blanker indicator (in **[NB]** switch) lights when the noise blanker is set to ON.
 - ➔ Push **[NB]** for 1 sec. to enter the noise blanker level set mode, then rotate the tuning dial to adjust the threshold level.
- **Notch filter** (p. 64)
 - ➔ Push **[NOTCH]** switch to turn the auto or manual notch function ON and OFF.
 - Rotate **[NOTCH]** control to set the attenuating frequency for manual notch operation.
 - Notch indicator (in **[NOTCH]** switch) lights when either the auto or manual notch is set to ON.
- **AGC (auto gain control)** (p. 59)
 - ➔ Push **[AGC]** switch several times to select AGC FAST, AGC MID or AGC SLOW.
 - ➔ Push **[AGC]** for 1 sec. to enter the AGC set mode.
 - Rotate the tuning dial to adjust the time constant.

◇ Convenient functions for transmit

- **Transmit quality monitor** (p. 70)
 - ➔ Push **[MONITOR]** to turn the monitor function ON and OFF.
 - Monitor indicator (in **[MONITOR]** switch) lights when the monitor function is set to ON.
 - ➔ Push **[EXIT/SET]** for 1 sec. then **[(F-1)LEVEL]** to enter level set mode. Select the monitor level item with **[(F-1)▲]/[(F-2)▼]** then rotate the tuning dial to adjust the monitor gain.
- **VOX (voice operated transmit)** (p. 66)
 - ➔ Push **[VOX]** to turn the VOX function ON and OFF.
 - “VOX ON” appears when the VOX function is set to ON.
- **Audio tone control** (p. 95)
 - ➔ Push **[EXIT/SET]** for 1 sec. then **[(F-1)LEVEL]** to enter level set mode. Select an item with **[(F-1)▲]/[(F-2)▼]** then rotate the tuning dial to adjust the audio tone.

■ Operating FM

[TRANSMIT] [TX] indicator [RX] indicator Band keys

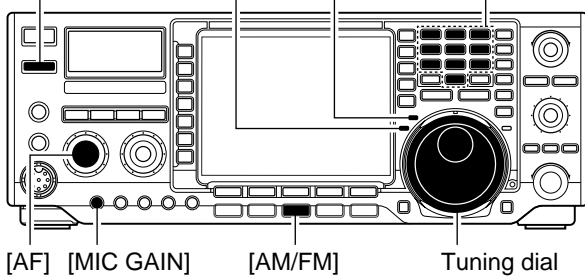

- ① Push a band key to select the desired band.
- ② Push **[AM/FM]** to select FM.
 - “FM” indicator appears.
 - After FM mode is selected, push **[AM/FM]** to toggle between FM and AM modes.
- ③ Rotate the tuning dial to tune a desired frequency.
 - The S-meter indicates received signal strength when signal is received.
 - 10 kHz tuning step is preset for FM mode.
- ④ Rotate **[AF]** to set audio to a comfortable listening level.
- ⑤ Push **[TRANSMIT]** or **[PTT]** (microphone) to transmit.
 - The TX indicator lights red.
- ⑥ Speak into the microphone at your normal voice level.
 - Adjust the microphone gain with **[MIC GAIN]** at this step, if necessary.
- ⑦ Push **[TRANSMIT]** or release **[PTT]** (microphone) to return to receive.

◇ Convenient functions for receive

• **Preamp** (p. 57)

- ➔ Push **[P.AMP]** several times to set the preamp OFF, preamp 1 ON or preamp 2 ON.
 - “P.AMP1” or “P.AMP2” appears when the preamp 1 or preamp 2 is set to ON, respectively. (depending on operating frequency band)

• **Attenuator** (p. 57)

- ➔ Push **[ATT]** several times to set the attenuator in 6 dB steps.
 - “ATT” and attenuation level appear when the attenuator is set to ON.

• **Notch filter** (p. 64)

- ➔ Push **[NOTCH]** switch to turn the auto notch function ON and OFF.
 - Rotate **[NOTCH]** control to set the attenuating frequency for manual notch operation.
 - Notch indicator (in **[NOTCH]** switch) lights when the auto notch is set to ON.

◇ Convenient functions for transmit

• **Transmit quality monitor** (p. 70)

- ➔ Push **[MONITOR]** to turn the monitor function ON and OFF.
 - Monitor indicator (in **[MONITOR]** switch) lights when the monitor function is set to ON.
- ➔ Push **[EXIT/SET]** for 1 sec. then **[(F-1)LEVEL]** to enter level set mode. Select the monitor level item with **[(F-1)▲]/[(F-2)▼]** then rotate the tuning dial to adjust the monitor gain.

• **VOX (voice operated transmit)** (p. 66)

- ➔ Push **[VOX]** to turn the VOX function ON and OFF.
 - “VOX ON” appears when the VOX function is set to ON.

• **Audio tone control** (p. 95)

- ➔ Push **[EXIT/SET]** for 1 sec. then **[(F-1)LEVEL]** to enter level set mode. Select an item with **[(F-1)▲]/[(F-2)▼]** then rotate the tuning dial to adjust the audio tone.

■ Repeater operation

A repeater amplifies received signals and retransmits them at a different frequency. When using a repeater, the transmit frequency is shifted from the receive frequency by an offset frequency. A repeater can be accessed using split frequency operation with the shift frequency set to the repeater's offset frequency.

For accessing a repeater which requires a repeater tone, set the repeater tone frequency in set mode as described below.

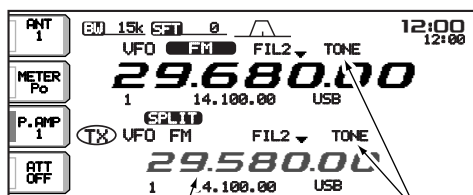
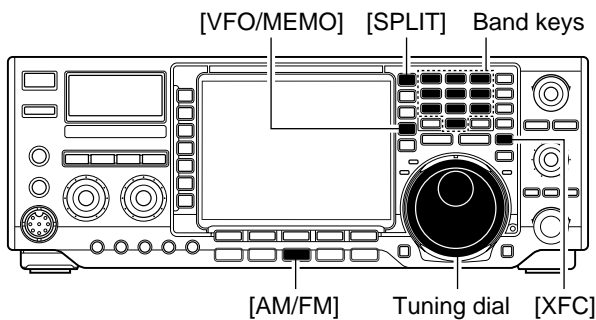

Shifted frequency appears. Tone encoder is automatically turned ON.

- ① Set the offset frequencies (HF, 50 MHz) and turn ON the quick split function in set mode (others) in advance. (p. 69)
- ② Push **[VFO/MEMO]** to select VFO mode.
- ③ Push the desired band key.
- ④ Push **[AM/FM]** several times to select FM mode.
- ⑤ Set the receive frequency (repeater output frequency).
- ⑥ Push **[SPLIT]** for 1 sec. to start repeater operation.
 - Repeater tone is turned ON automatically.
 - Shifted transmit frequency and "TX" appear in the sub readout.
 - The transmit frequency can be monitored while pushing **[XFC]** or using dualwatch.
- ⑦ Push and hold **[PTT]** to transmit; release **[PTT]** to receive.
- ⑧ To return to simplex, push **[SPLIT]** momentarily to clear the sub display.

◇ Setting the repeater tone

Some repeaters require subaudible tones to be accessed. Subaudible tones are superimposed over your normal signal and must be set in advance. The transceiver has 50 tones from 67.0 Hz to 254.1 Hz.

Each memory channel can store an independent setting.

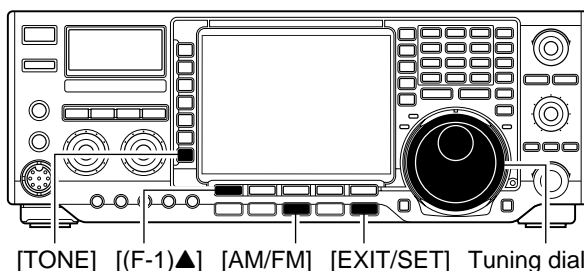

CONVENIENT

Store repeater tone frequencies and ON/OFF settings in memory channels for easy recall.

- ① Select FM mode.
- ② Push **[TONE]** for 1 sec. to enter tone set mode.
- ③ Push **[(F-1)▲]** to select "REPEATER TONE" item.
- ④ Rotate the tuning dial to select the desired repeater tone frequency.

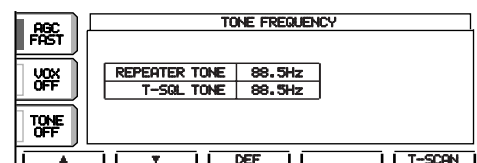

- ⑤ Push **[EXIT/SET]** to exit tone set mode.

Available repeater tones

(Unit: Hz)

67.0	85.4	107.2	136.5	165.5	186.2	210.7	254.1
69.3	88.5	110.9	141.3	167.9	189.9	218.1	
71.9	91.5	114.8	146.2	171.3	192.8	225.7	
74.4	94.8	118.8	151.4	173.8	196.6	229.1	
77.0	97.4	123.0	156.7	177.3	199.5	233.6	
79.7	100.0	127.3	159.8	179.9	203.5	241.8	
82.5	103.5	131.8	162.2	183.5	206.5	250.3	

■ Tone squelch operation

The tone squelch opens only when receiving a signal containing a matching subaudible tone. You can silently wait for calls from group members using the same tone.

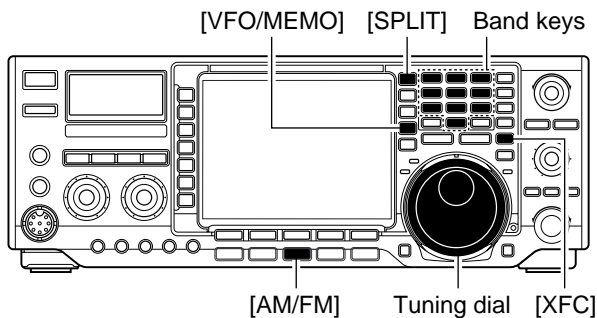

Available tone squelch tones (Unit: Hz)

67.0	85.4	107.2	136.5	165.5	186.2	210.7	254.1
69.3	88.5	110.9	141.3	167.9	189.9	218.1	
71.9	91.5	114.8	146.2	171.3	192.8	225.7	
74.4	94.8	118.8	151.4	173.8	196.6	229.1	
77.0	97.4	123.0	156.7	177.3	199.5	233.6	
79.7	100.0	127.3	159.8	179.9	203.5	241.8	
82.5	103.5	131.8	162.2	183.5	206.5	250.3	

- ① Set the desired frequency band and select FM mode.
- ② Push **[TONE]** several times until “TSQL” appears.

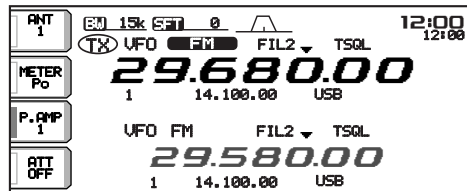

- ③ Push **[TONE]** for 1 sec. to enter tone set mode.

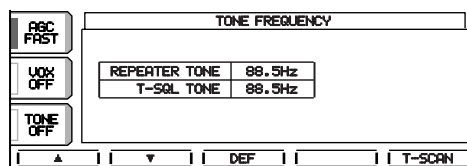

- ④ Push **[(F-2)▼]** to select the “T-SQL TONE” item.
- ⑤ Rotate the tuning dial to select the desired tone squelch frequency.
 - Push **[(F-3)DEF]** for 1 sec. to select the default setting.
- ⑥ Push **[EXIT/SET]** to return to the previous indication.
- ⑦ When the received signal includes a matching tone, squelch opens and the signal can be heard.
 - When the received signal’s tone does not match, tone squelch does not open, however, the S-indicator shows signal strength.
 - To open the squelch manually, push **[XFC]**.
- ⑧ Operate the transceiver in the normal way.
- ⑨ To cancel the tone squelch, push **[TONE]** to clear “TSQL.”

CONVENIENT

Store tone squelch frequencies and ON/OFF settings in memory channels for easy recall.

■ Data mode (SSTV/PSK31) operation

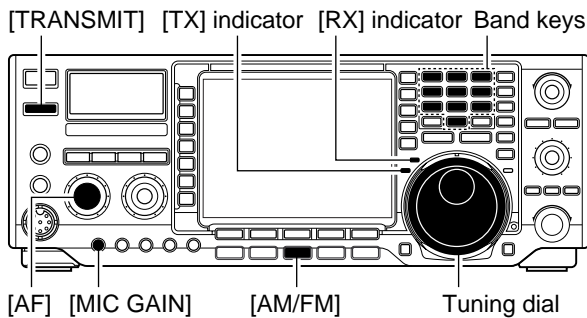

When operating SSTV or PSK31 with your PC software, consult the manual that comes with the software.

- ① Connect a PC to the transceiver. (p. 19)
- ② Push a band key to select the desired band.
- ③ Push **[SSB]** or **[AM/FM]** to select the desired operating mode.
- ④ Push the same key for 1 sec. to turn data mode ON.
 - “-D” indicator additionally appears.
- ⑤ Rotate the tuning dial to tune into the desired signal and decoded correctly.
 - Also use the tuning indicator of the software.
 - During SSB data mode, 1/4 tuning function can be used for critical tuning.
- ⑥ Operate the PC (software) to transmit.
 - When operating in SSB data mode, adjust the AF output level from PC so that the ALC meter reading doesn't go outside the ALC zone.

✓ For your information

Carrier point frequency is displayed when SSB data mode is selected.

See the diagram below for the tone-pair example.

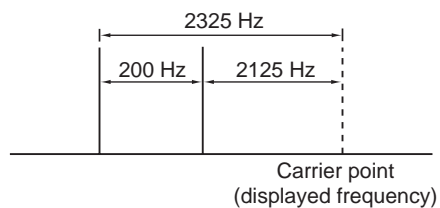

NOTE: When SSB data mode is selected, the audio input from the **[ACC(1)]** (pin 6) is used for transmission instead of **[MIC]**'s.

The fixed condition is used for SSB data transmission as follow.

- **[COMP]** : OFF
- Tx bandwidth : MID
- Tx Tone (Bass) : 0
- Tx Tone (Trebles) : 0

■ Spectrum scope screen

This function allows you to display the relative strengths of signals around the center frequency. The span can be set to ± 12.5 kHz, ± 25 kHz, ± 50 kHz and ± 100 kHz. Ideal for monitoring band conditions in an instant.

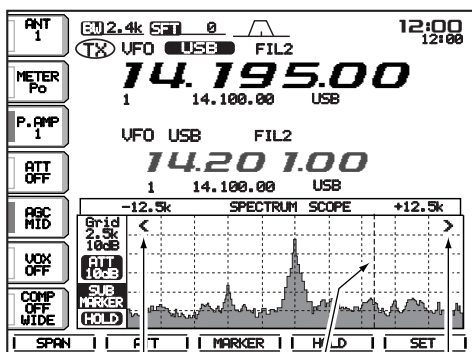
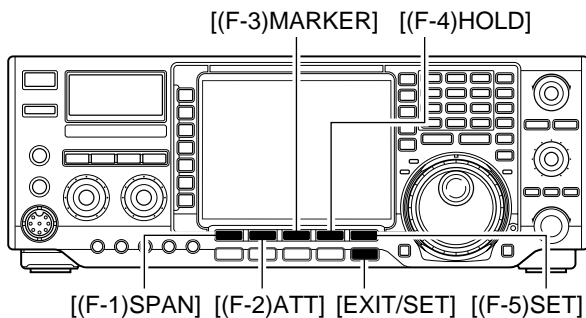

Appears when the marker is out of range. Sub readout or TX marker Appears when the marker is out of range.

- ① Push **[EXIT/SET]** several times to close a multi-function screen, if necessary.
- ② Push **[(F-1)SCOPE]** to select the scope screen.
- ③ Push **[(F-1)SPAN]** several times to select the scope span.
- ④ Push **[(F-2)ATT]** several times to activate an attenuator or turn the attenuator OFF.
 - 10, 20 and 30 dB attenuators are available.
- ⑤ Push **[(F-3)MARKER]** several times to select the marker (sub readout or transmit frequency) or turn the marker OFF.
 - “TX MARKER” displays the marker at the transmit frequency.
 - “SUB MARKER” displays the marker at the sub readout frequency.
- ⑥ Push **[(F-4)HOLD]** to freeze the current spectrum waveform.
 - “HOLD” appears while the function is in use.
- ⑦ Push **[EXIT/SET]** to exit the scope screen.

▨ If a strong signal is received, a ghost waveform may appear. Push **[(F-2)ATT]** several times to activate the spectrum scope attenuator in this case.

◇ Mini scope screen

This mini scope screen can be displayed with another screen indication, such as set mode menu, decoder screen, memory list screen, etc. simultaneously.

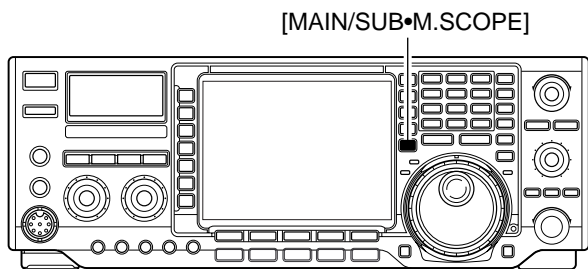

- ➡ Push **[MAIN/SUB•M.SCOPE]** for 1 sec. to toggle the mini scope indication ON and OFF.

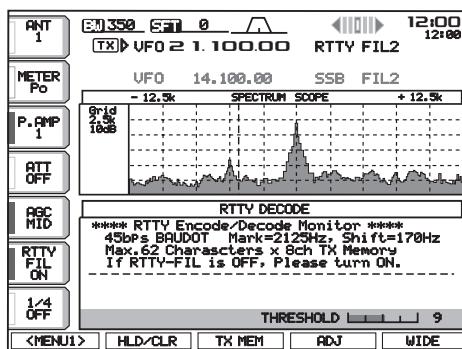

◇ Scope set mode

The spectrum scope shows the transmit signal waveform while transmitting. This can be deactivated if desired.

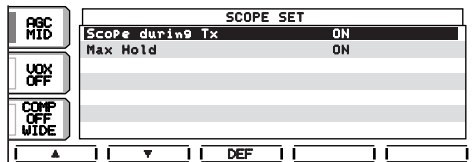
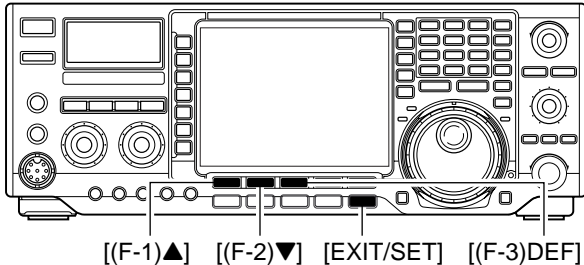

The spectrum scope shows the transmit signal waveform while transmitting. This can be deactivated if desired.

When “OFF” is selected, the spectrum scope holds the received waveform while transmitting and does not show the transmit waveform.

- ① During spectrum scope indication ON, push **[(F-5)SET]** to select scope set mode screen.
- ② Push **[(F-5)SET]** to select the spectrum scope set mode.
- ③ Push **[(F-1)▲]** or **[(F-2)▼]** to select the desired set item.
- ④ Rotate the tuning dial to select the desired condition.
 - Push **[(F-3)DEF]** for 1 sec. to select a default condition.
- ⑤ Push **[EXIT/SET]** to exit spectrum scope set mode.

5

Scope during Tx

Turn the transmitting signal waveform indication ON and OFF.

When “OFF” is selected, the spectrum scope holds the received waveform while transmitting and does not show the transmit waveform. (default: ON)

Max Hold

Turn the peak level holding function ON and OFF.

(default: ON)

■ Preamplifier

The preamp amplifies received signals in the front end circuit to improve the S/N ratio and increase the sensitivity. Set this to preamp 1 or preamp 2 when receiving weak signals.

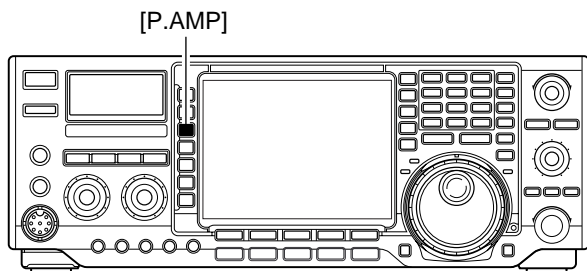

➔ Push **[P.AMP]** several times to set the preamp OFF, preamp 1 ON or preamp 2 ON.

- “P. AMP1” activates 10 dB preamp for HF all bands.
- “P. AMP2” activates 16 dB high-gain preamp for 24 MHz band and above.

Regarding the use of the “P.AMP 2” (Pre-amplifier 2)

The “P.AMP 2” is a high gain receive amplifier. When the “P.AMP 2” is used during times of strong electric fields, distortion sometimes results. In such cases, use the transceiver with the “P.AMP 1” or “P.AMP OFF” setting.

The “P.AMP 2” is most effective when:

- Used on bands above 24 MHz and when electric fields are weak.
- Receive sensitivity is insufficient during low gain, or while using a narrow band antenna (such as small loop, a Beverage antenna or a short Yagi antenna, etc.) is used.

■ Attenuator

The attenuator prevents a desired signal from distortion when very strong signals are near the desired frequency or when very strong electric fields, such as from broadcasting stations, are near your location.

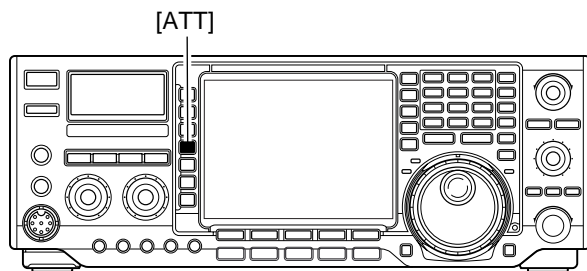

➔ Push **[ATT]** several times to set the attenuator 6 dB, 12 dB, 18 dB or OFF.

- “ATT 6dB,” “ATT 12dB,” “ATT 18dB” and “ATT OFF” appears respectively.

RIT function

The RIT (Receive Increment Tuning) function compensates for off-frequencies of the communicating station.

The function shifts the receive frequency up to ± 9.999 kHz in 1 Hz steps (10 Hz steps when cancelling the 1 Hz step readout) without moving the transmit frequency.

• See ③ on p. 5 for function description.

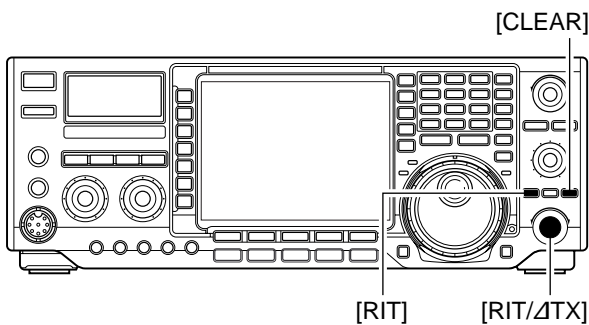

When RIT and Δ TX are ON at the same time, the [RIT/ Δ TX] control shifts both the transmit and receive frequencies from the displayed frequency at the same time.

- Push [RIT] to turn the RIT function ON and OFF.
 - “RIT” and the shifting frequency appear when the function is ON.

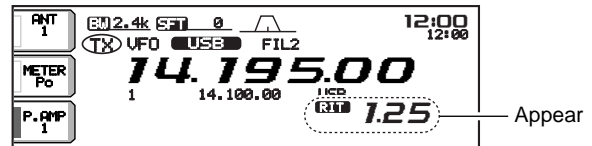

- Rotate the [RIT/ Δ TX] control.



- To reset the RIT frequency, push [CLEAR] for 1 sec.
 - Push [CLEAR] momentarily to reset the RIT frequency when the quick RIT/ Δ TX clear function is ON. (p. 103)

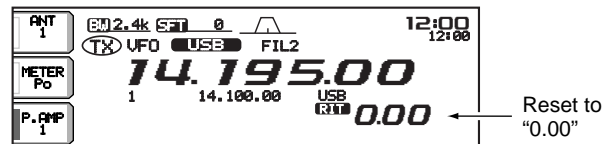

- To cancel the RIT function, push [RIT] again.
 - “RIT” disappears.

Calculate function

The shift frequency of the RIT (or Δ TX) function can be added/subtracted to the displayed frequency.

While displaying the RIT (and/or Δ TX) shift frequency, push [RIT] (or [Δ TX]) for 1 sec.

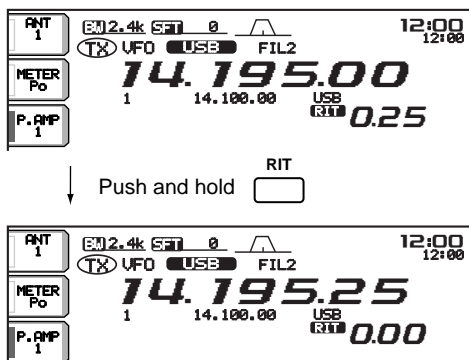

Practical example

When you find a DX station on 21.025 MHz/CW and the station is picking up stations transmitting slightly up from 21.025 MHz.

- Push [RIT] and [Δ TX] to turn both the RIT and Δ TX functions ON.
- Rotate [RIT/ Δ TX] to find the DX station's receive frequency.
- When you find the DX station's receive frequency, push [RIT] to turn the RIT function OFF.
 - Now you can transmit the DX station's receive frequency and receive the DX station's transmit frequency (21.025 MHz).
- Start transmitting while the station is standing by.

AGC function

The AGC (auto gain control) controls receiver gain to produce a constant audio output level even when the received signal strength is varied by fading, etc.

The transceiver has 3 AGC characteristics (time constant; fast, mid, slow) for non-FM mode.

The FM mode AGC time constant is fixed as 'FAST' (0.1 sec.) and AGC time constant cannot be selected.

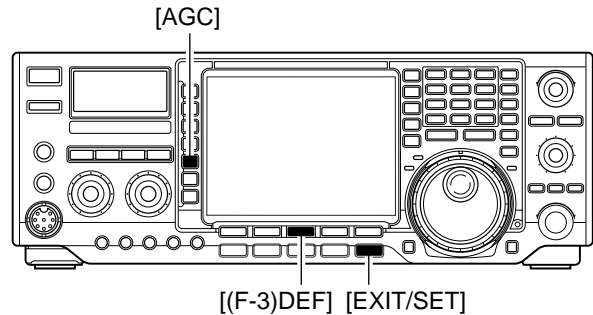

AGC time constant selection

- 1 Select non-FM mode.
- 2 Push **[AGC]** several times to select AGC fast, AGC medium (MID) or AGC slow.

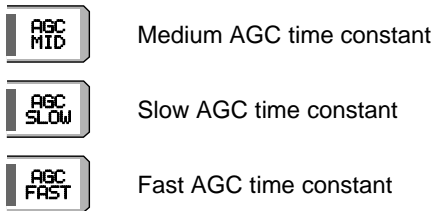

Selectable AGC time constant (unit: sec.)

Mode	Default	Selectable AGC time constant
SSB	0.3 (FAST)	OFF, 0.1, 0.2, 0.3, 0.5, 0.8, 1.2, 1.6, 2.0, 2.5, 3.0, 4.0, 5.0, 6.0
	2.0 (MID)	
	6.0 (SLOW)	
CW	0.1 (FAST)	OFF, 0.1, 0.2, 0.3, 0.5, 0.8, 1.2, 1.6, 2.0, 2.5, 3.0, 4.0, 5.0, 6.0
	0.5 (MID)	
	1.2 (SLOW)	
RTTY	0.1 (FAST)	OFF, 0.1, 0.2, 0.3, 0.5, 0.8, 1.2, 1.6, 2.0, 2.5, 3.0, 4.0, 5.0, 6.0
	0.5 (MID)	
	1.2 (SLOW)	
AM	3.0 (FAST)	OFF, 0.3, 0.5, 0.8, 1.2, 1.6, 2.0, 2.5, 3.0, 4.0, 5.0, 6.0, 7.0, 8.0
	5.0 (MID)	
	7.0 (SLOW)	
FM	0.1 (FAST)	Fixed

Setting the AGC time constant

- 1 Select the desired mode other than FM mode.
- 2 Push **[AGC]** for 1 sec. to enter AGC set mode.

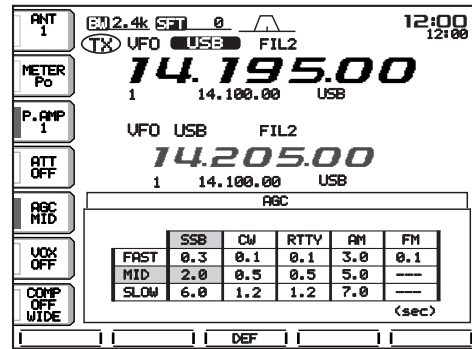

- 3 Push **[AGC]** several times to select FAST time constant.
- 4 Rotate the tuning dial to set the desired time constant for 'AGC FAST.'
 - AGC time constant can be set between 0.1 to 8.0 sec. (depends on mode) or turned OFF.
 - Push **[(F-3)DEF]** for 1 sec. to select a default value.
- 5 Push **[AGC]** to select medium time constant.
- 6 Rotate the tuning dial to set the desired time constant for 'AGC MID.'
 - AGC time constant can be set between 0.1 to 8.0 sec. (depends on mode) or turned OFF.
 - Push **[(F-3)DEF]** for 1 sec. to select a default value.
- 7 Push **[AGC]** to select slow time constant.
- 8 Rotate the tuning dial to set the desired time constant for 'AGC SLOW.'
 - AGC time constant can be set between 0.1 to 8.0 sec. (depends on mode) or turned OFF.
 - Push **[(F-3)DEF]** for 1 sec. to select a default value.
- 9 Select another mode other than FM. Repeat steps 3 to 8 if desired.
- 10 Push **[EXIT/SET]** to exit the AGC set mode screen.

■ Twin PBT operation

General PBT (Passband Tuning) function electronically narrows the IF passband width by shifting the IF frequency to slightly outside of the IF filter passband to reject interference. This transceiver uses the DSP circuit for the PBT function. Moving both **[TWIN PBT]** controls to the same position shifts the IF.

- ➔ The LCD shows the passband width and shift frequency graphically.
- ➔ Push **[FILTER]** for 1 sec. to enter the filter set mode. Current passband width and shift frequency is displayed in the filter set mode screen.
- ➔ To set the **[TWIN PBT]** controls to the center positions, push **[PBT CLR]** for 1 sec.

The variable range depends on the passband width and mode. The edge of the variable range is half of the passband width, and PBT is adjustable in 25 or 50 Hz steps. These controls function as an IF shift control while in AM mode and when the RTTY filter is turned ON. Only the inner control may function in this case. IF shift is adjustable in 20/40 Hz steps in RTTY (RTTY filter is turned ON) or 150/300/500 Hz steps in AM.

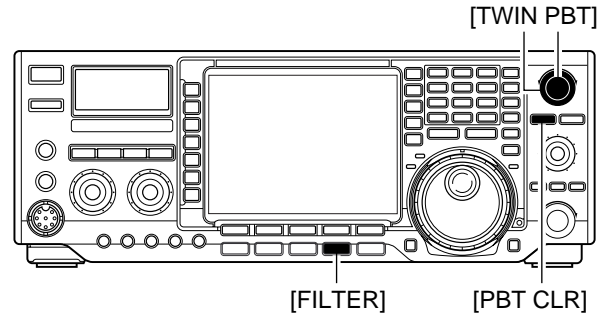

Shows filter width, shifting value and condition

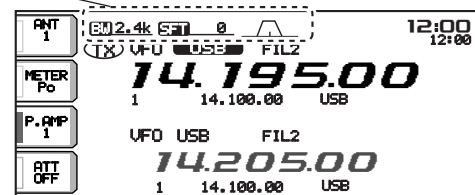

- **[TWIN PBT]** should normally be set to the center positions (PBT setting is cleared) when there is no interference.
- When PBT is used, the audio tone may be changed.
- Not available for FM mode.
- While rotating **[TWIN PBT]**, noise may occur. This comes from the DSP unit and does not indicate an equipment malfunction.

PBT OPERATION EXAMPLE

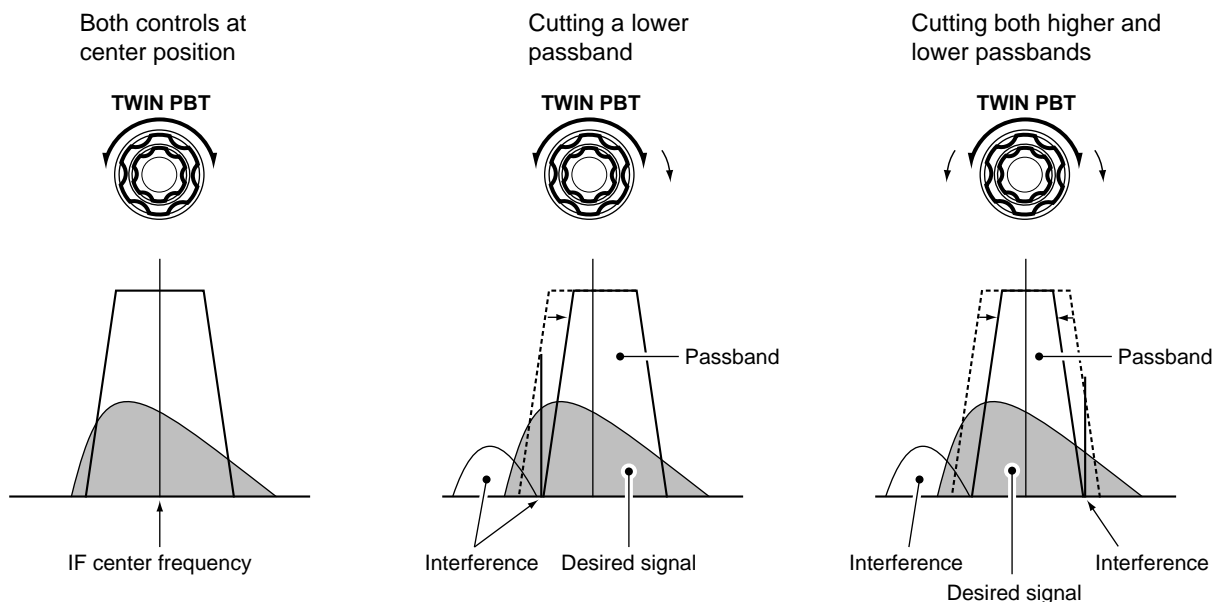

IF filter selection

The transceiver has 3 passband width IF filters for each mode.

For SSB and CW modes, the passband width can be set within 50 to 3600 Hz in 50 or 100 Hz steps. A total of 41 passband widths are available.

For RTTY mode, the passband width can be set within 50 to 2700 Hz in 50 or 100 Hz steps. A total of 32 passband widths are available.

For AM and FM modes, the passband width is fixed and 3 passband widths are available.

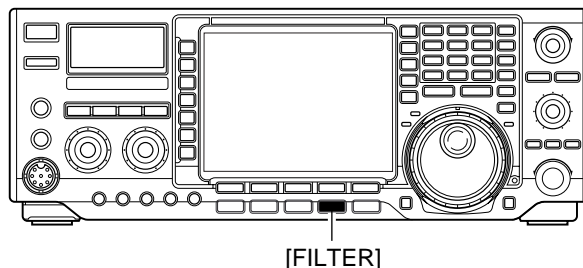

- ▨ The filter selection is automatically memorized in each mode.
- ▨ The PBT shift frequencies are automatically memorized in each filter.

•IF filter selection

- ① Select the desired mode.
- ② For RTTY mode, turn OFF the RTTY filter by pushing [RTTY FIL].
- ③ Push [FILTER] several times to select the IF filter 1, 2 or 3.
 - The selected passband width and filter number is displayed in the LCD.

•Filter passband width setting (SSB, CW and RTTY mode only)

- ① Select SSB, CW or RTTY mode.
 - Passband widths for AM and FM modes are fixed and cannot be set.
- ② For RTTY mode, turn OFF the RTTY filter by pushing [RTTY FIL].
- ③ Push [FILTER] for 1 sec. to enter filter set mode.
- ④ Push [FILTER] several times to select the desired IF filter.
- ⑤ While pushing [(F-1)BW], rotate the tuning dial to set the desired passband width.
 - The passband width can be set within the range as shown right table.
 - Push [(F-3)DEF] for 1 sec. to select the default value.
- ⑥ Repeat steps ④ to ⑤ if desired.
- ⑦ Push [EXIT/SET] to exit the filter set mode screen.

▨ The PBT shift frequencies are cleared when the passband width is changed.

▨ This filter set mode screen graphically displays the PBT shift frequencies and CW pitch operations.

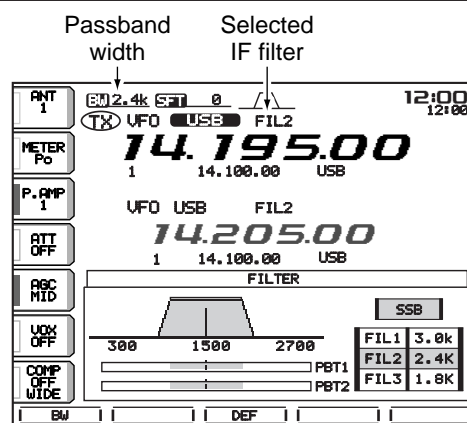

Mode	Filter	Default	Range (Steps)
SSB	FIL1	3.0 kHz	50–500 Hz (50 Hz)/ 600–3.6 kHz (100 Hz)
	FIL2	2.4 kHz	
	FIL3	1.8 kHz	
SSB-D CW	FIL1	1.2 kHz	50–500 Hz (50 Hz)/ 600–3.6 kHz (100 Hz)
	FIL2	500 Hz	
	FIL3	250 Hz	
RTTY	FIL1	2.4 kHz	50–500 Hz (50 Hz)/ 600–2.7 kHz (100 Hz)
	FIL2	500 Hz	
	FIL3	250 Hz	
AM	FIL1	9.0 kHz	Fixed
	FIL2	6.0 kHz	
	FIL3	3.0 kHz	
FM*	FIL1	15 kHz	Fixed
	FIL2	10 kHz	
	FIL3	7.0 kHz	

*: When the IF filter is selected FIL2 or FIL3 in the FM mode operation, the Tx IF filter's passband width is fixed narrow selection (2.5 kHz).

■ DSP filter shape

The type of DSP filter shape for each SSB and CW can be selected independently from soft and sharp.

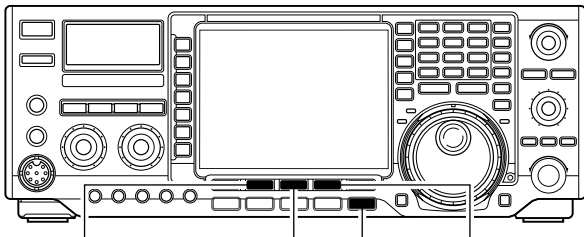

[(F-2)SSB-FIL] [(F-3)DSP] [EXIT/SET] [(F-4)CW-FIL]

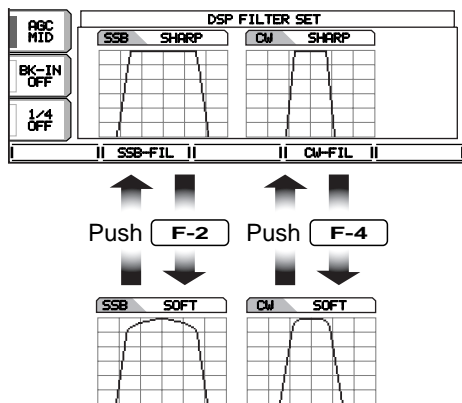

- ① Push **[EXIT/SET]** several times to close a multi-function screen, if necessary.
- ② Push **[EXIT/SET]** switch for 1 sec. to enter set mode.
- ③ Push **[(F-3)DSP]** to enter the DSP filter set mode.
- ④ Push one of **[(F-2)SSB-FIL]** or **[(F-4)CW-FIL]** to select the desired DSP filter shape from sharp and soft for each SSB or CW mode, respectively.
- ⑤ Push **[EXIT/SET]** twice to exit the set mode.

Dualwatch operation

Dualwatch monitors 2 frequencies with the same mode simultaneously.

During dualwatch, both frequencies should be on the same band, because the bandpass filter in the RF circuit is selected for the main readout frequency.

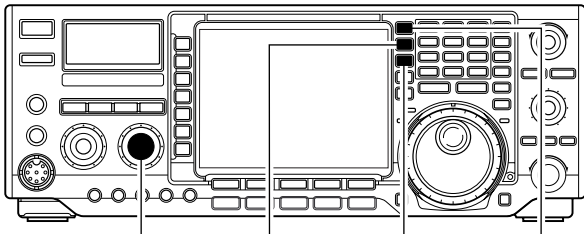

[BAL] [DUALWATCH] [CHANGE] [SPLIT]

▨ RIT function can be used for the main readout only.
 ▨ ΔTX function can be used for the transmit readout (main readout when the split function is OFF; sub readout when the split function is ON).

- ① Set a desired frequency.
- ② Push **[DUALWATCH]** for 1 sec.
 - Equalized receive frequency and “**DUAL-W**” appear in the LCD. This quick dualwatch function can be turned OFF in set mode. (p. 100)
 - Pushing **[DUALWATCH]** momentarily activates the dualwatch with the previously operated frequency.

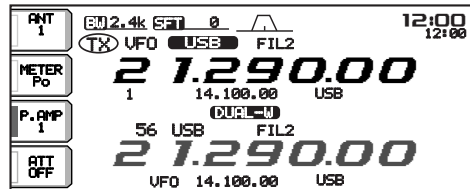

- ③ Set another desired frequency using the tuning dial.
- ④ Adjust **[BAL]** to set a suitable signal strength balance between the main and sub readout frequencies.
 - S-meter shows the combined signal strength.
- ⑤ To transmit on the sub readout frequency, push **[CHANGE]** or **[SPLIT]**.

Scanning during dualwatch

Scanning operates only for the main readout. To operate the scan during dualwatch, scan on the main readout and use the sub readout for your QSO using both dualwatch and split frequency operation.

- ① Program the desired programmed scan edges in the same amateur band. See p. 79 for programming.
 - If you plan to operate a ΔF scan, programming the scan edges may not be necessary.
- ② Push **[SPLIT]** to turn the split frequency function ON.
 - “**SPLIT**” appears.

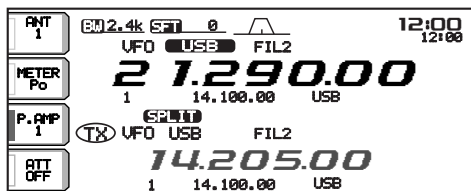

- ③ Select VFO mode for the main readout.
- ④ Set the desired operating frequency for the main readout.
- ⑤ Push **[DUALWATCH]** for 1 sec.
 - The main and sub readout frequencies are equalized and the dualwatch function is turned ON.

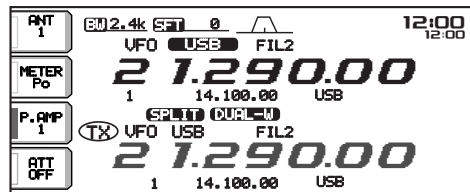

- ⑥ Push **[(F-5)SCAN]** to select the scan screen.
 - Push **[EXIT/SET]** several times to close a multi-function screen, if necessary.
- ⑦ Push **[(F-1)PROG]** or **[(F-2)ΔF]** to start the programmed scan or ΔF scan, respectively.
 - Scan activates on the main readout between the programmed scan edges or within the ΔF span.
 - Transmitting on the sub readout stops the scan.

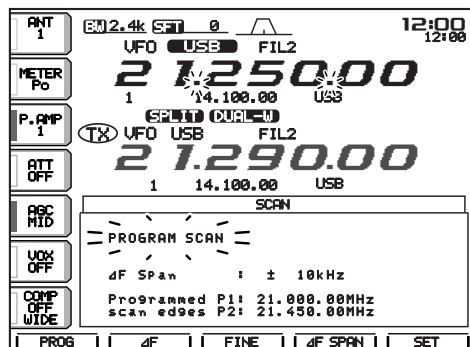

- ⑧ To cancel the scan, push **[EXIT/SET]**.

■ Noise blanker

The noise blanker eliminates pulse-type noise such as from car ignitions. The noise blanker is not available for FM mode.

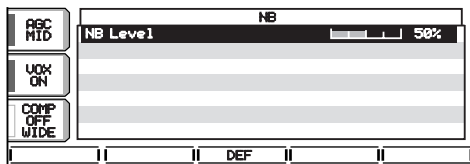
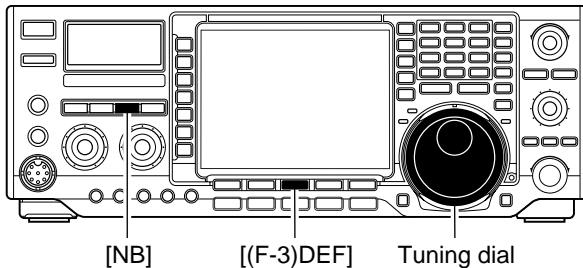

- ① Push **[NB]** to turn the noise blanker ON.
 - **[NB]** indicator lights.
- ② Push **[NB]** for 1 sec. to enter the noise blanker level set mode.
- ③ Rotate the tuning dial to adjust the noise blanker level.
 - Push **[(F-3)DEF]** for 1 sec. to return to default value.
- ④ Push **[NB]** to turn the noise blanker OFF.
 - **[NB]** indicator goes off.

When using the noise blanker, received signals may be distorted if they are excessively strong.

5

■ Notch function

This transceiver has auto and manual notch functions. The auto notch function automatically attenuates more than 3 beat tones, tuning signals, etc., even if they are moving. The manual notch can be set to attenuate a frequency via the **[NOTCH]** control.

- ➔ Push **[NOTCH]** to toggle the notch function between auto, manual and OFF in SSB and AM modes.
- ➔ Push **[NOTCH]** to turn the manual notch function ON and OFF in CW mode.
- ➔ Push **[NOTCH]** to turn the auto notch function ON and OFF in FM mode.
 - Set to attenuate a frequency for manual notch via the **[NOTCH]** control.
 - “AN” appears when auto notch is in use.
 - “MN” appears when manual notch is in use.

While operating the manual notch, noise may be heard. This comes from the DSP unit and does not indicate an equipment malfunction.

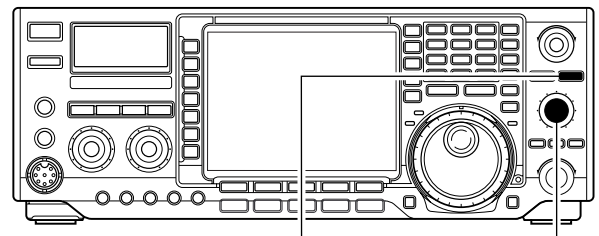

[NOTCH](switch) [NOTCH](control)

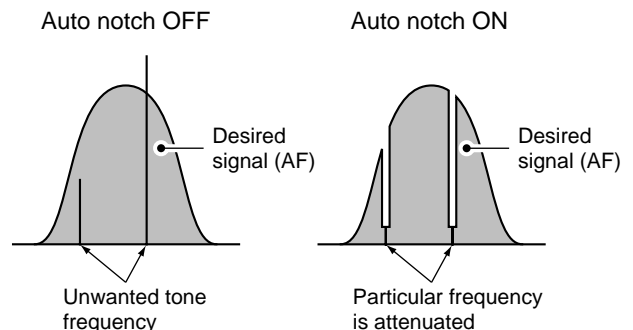

■ Noise reduction

The noise reduction function reduces noise components and picks out desired signals which are buried in noise. The received signals are converted to digital signals and then the desired signals are separated from the noise.

- ① Push the **[NR]** switch to turn the noise reduction ON.
 - **[NR]** indicator lights.
- ② Rotate the **[NR]** control to adjust the noise reduction level.
- ③ Push the **[NR]** switch to turn the noise reduction OFF.
 - **[NR]** indicator lights off.

/// Deep rotation of the **[NR]** control results in audio signal masking or distortion. Set the **[NR]** control for maximum readability.

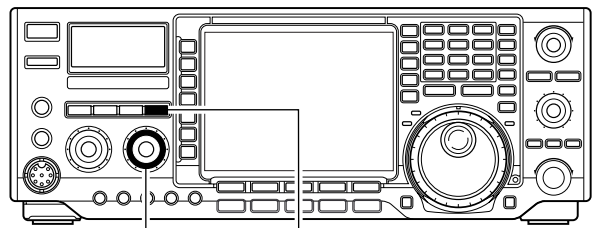

[NR](control) [NR](switch)

Noise reduction OFF

Noise reduction activated

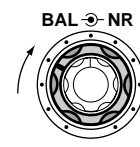
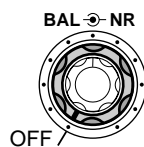

Noise components

Desired signal (CW)

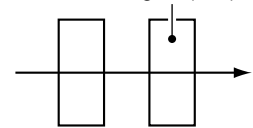
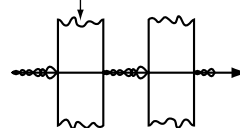

■ Dial lock function

The dial lock function prevents changes by accidental movement of the tuning dial. The lock function electronically locks the dial.

- ➔ Push **[LOCK/SPEECH]** to toggle the dial lock function ON and OFF.
 - The **[LOCK]** indicator lights when the dial lock function is in use.

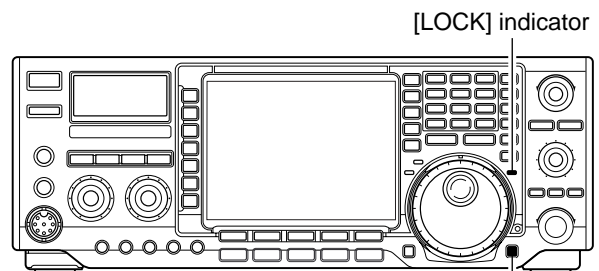

[LOCK/SPEECH] switch

■ VOX function

The VOX (Voice-Operated Transmission) function switches between transmit and receive with your voice. This function provides an opportunity to input log entries into your computer, etc., while operating.

◇ Using the VOX function

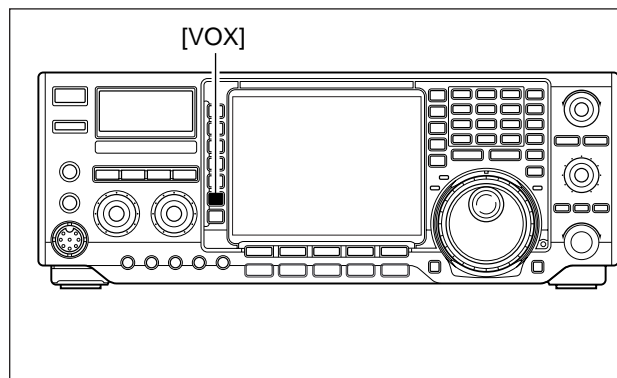

- ① Select a phone mode (SSB, AM, FM).
- ② Push **[VOX]** to turn the VOX function ON or OFF.
 - “VOX ON” appears while the VOX is in use.

◇ Adjusting the VOX function

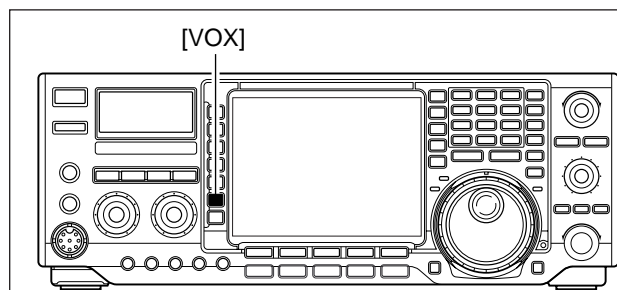

- ① Select a phone mode (SSB, AM, FM).
- ② Push **[VOX]** to turn VOX function ON.
- ③ Push **[VOX]** for 1 sec. to enter VOX set mode.
- ④ Select the VOX gain item using **[(F-1)▲]** or **[(F-2)▼]**.
- ⑤ While speaking into the microphone, rotate the tuning dial to the point where the transceiver is continuously transmitting.
- ⑥ Adjust the VOX delay for a convenient interval before returning to receive.
 - Select the VOX delay item using **[(F-1)▲]** or **[(F-2)▼]**.
 - Rotate the tuning dial.
- ⑦ If the receive audio from the speaker switches to transmit, adjust the anti VOX to the point where it has no effect.

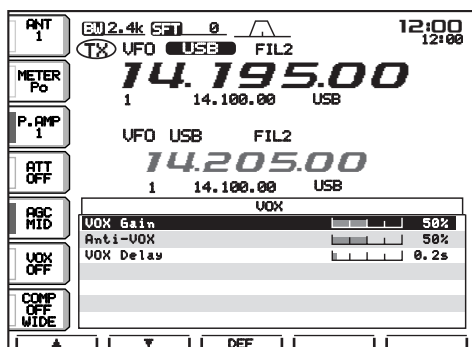

5
6

■ Break-in function

The break-in function is used in CW mode to automatically toggle the transceiver between transmit and receive when keying. The IC-756PROIII is capable for full break-in or semi break-in.

◇ Semi break-in operation

During semi break-in operation, the transceiver selects transmit when keying, then automatically returns to receive after a pre-set time from when you stop keying.

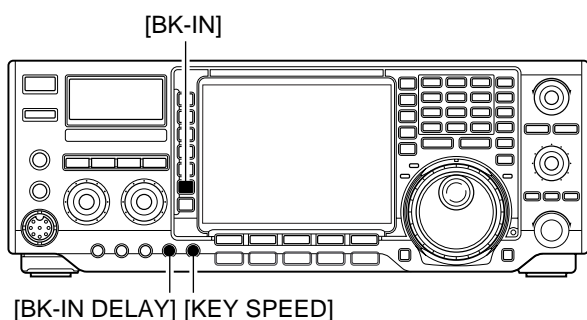

- ① Push **[CW/RTTY]** to select CW or CW-R mode.
- ② Push **[BK-IN]** several times to turn the semi break-in function ON.
 - “BK-IN SEMI” appears.
- ③ Rotate **[BK-IN DELAY]** to set the break-in delay time (the delay from transmit to receive).

When using a paddle, rotate **[KEY SPEED]** to adjust the keying speed.

◇ Full break-in operation

During full break-in operation, the transceiver automatically selects transmit while keying and returns to receive immediately after keying is finished.

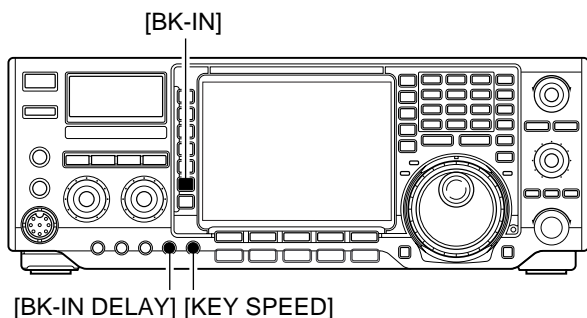

- ① Push **[CW/RTTY]** to select CW or CW-R mode.
- ② Push **[BK-IN]** several times to turn the full break-in function ON.
 - “BK-IN FULL” appears.

When using a paddle, rotate **[KEY SPEED]** to adjust the keying speed.

■ Transmit filter width setting (SSB only)

The transmit filter width for SSB mode can be selected from wide, middle and narrow.

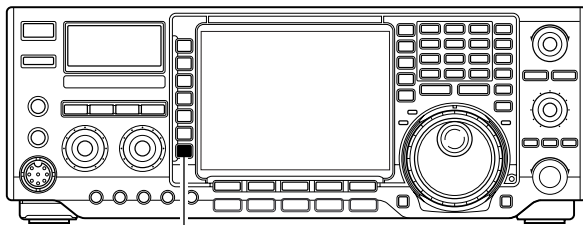

[COMP]

➔ During USB or LSB mode selection, push **[COMP]** for 1 sec. several times to select the desired transmit filter width from wide, middle and narrow.

- The filter functions regardless of the speech compressor use.

- The following filters are specified as the default. Each of the filter width can be re-set in level set mode. (pgs. 95, 96)

WIDE : 100 Hz to 2.9 kHz

MID : 300 Hz to 2.7 kHz

NAR : 500 Hz to 2.5 kHz

■ Speech compressor

The speech compressor increases average RF output power, improving signal strength and readability in SSB mode.

• Speech compressor

- ① Select USB or LSB mode.
- ② Push **[COMP]** momentarily to turn the speech compressor ON and OFF.
- ③ Push **[COMP]** for 1 sec. to select between narrow, middle or wide transmit filter.

- Transmit filter width: (see above for details)

NAR 2.0 kHz

MID 2.4 kHz

WIDE 2.8 kHz

• Compression level setting

- ① Select USB or LSB mode.
- ② Preset the transceiver as follows:
 - 'COMP' function : OFF
 - 'METER' function : ALC
 - [MIC GAIN]** control : Center position
 - [COMP]** control : Center position
 - [RF POWER]** control : Max. counterclockwise
- ③ Transmit at your normal voice level.
- ④ Adjust the **[MIC GAIN]** control so that the ALC meter reads within the ALC zone, whether or not you speak softly or loudly.
- ⑤ Push **[COMP]** momentarily to turn the speech compressor ON.
- ⑥ Push **[METER]** once to select the COMP meter.
- ⑦ Adjust the **[COMP]** control so that the COMP meter reads within 10 dB and 20 dB.

COMP meter

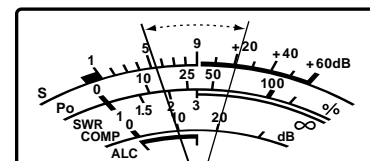

When the ALC meter peaks above the ALC zone, your transmitted voice may be distorted.

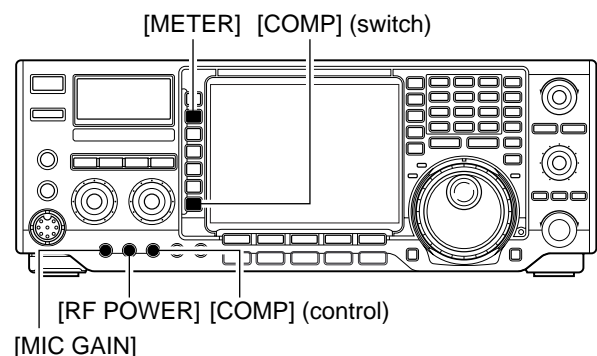

■ ΔTX function

The ΔTX function shifts the transmit frequency up to ±9.999 kHz in 1 Hz steps (10 Hz steps when cancelling the 1 Hz step readout) without moving the receive frequency.

• See 29 on p. 5 for function description.

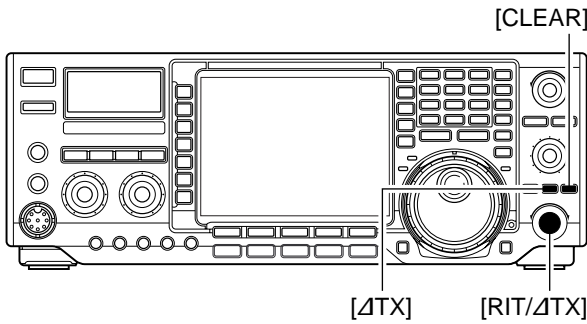

When RIT and ΔTX are ON at the same time, the [RIT/ΔTX] control shifts both the transmit and receive frequencies from the displayed frequency at the same time.

- Push [ΔTX] switch.
 - “ΔTX” and the shifting frequency appear when the function is ON.

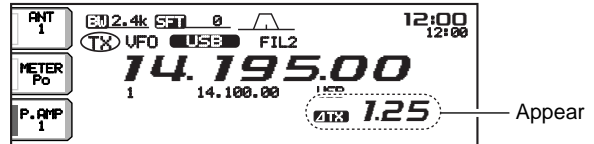

- Rotate the [RIT/ΔTX] control.



- To reset the ΔTX frequency, push [CLEAR] for 1 sec.
 - Push [CLEAR] momentarily to reset the RIT frequency when the quick RIT/ΔTX clear function is ON. (p. 103)

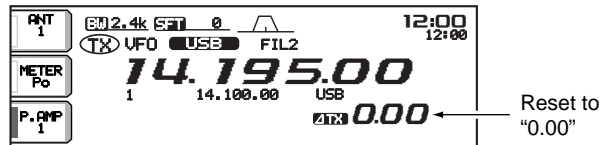

- To cancel the ΔTX function, push [ΔTX] again.
 - “ΔTX” and the shifting frequency disappears.

• Calculate function

The shift frequency of the (RIT or) ΔTX function can be added/subtracted to the displayed frequency.

While displaying the (RIT and/or) ΔTX shift frequency, push ([RIT] or) [ΔTX] for 1 sec.

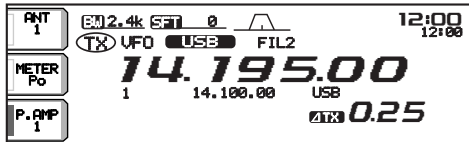

Push and hold ΔTX

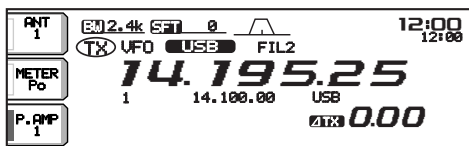

• Practical example

When you find a DX station on 21.025 MHz/CW and the station is picking up stations transmitting slightly up from 21.025 MHz.

- Push [RIT] and [ΔTX] to turn both the RIT and ΔTX functions ON.
- Rotate [RIT/ΔTX] to find the DX station's receive frequency.
- When you find the DX station's receive frequency, push [RIT] to turn the RIT function OFF.
 - Now you can transmit the DX station's receive frequency and receive the DX station's transmit frequency (21.025 MHz).
- Start transmitting while the station is standing by.

■ Monitor function

The monitor function allows you to monitor your transmit IF signals in any mode through the speaker. Use this to check voice characteristics while adjusting SSB transmit tones. (p. 95) The CW side tone functions regardless of the **[MONITOR]** switch setting.

- ① Push **[MONITOR]**.
 - The indicator (in **[MONITOR]** switch) lights when the monitor function is ON.
- ② Push **[EXIT/SET]** several times to close a multi-function screen, if necessary.
- ③ Push **[EXIT/SET]** for 1 sec. then **[(F-1)LEVEL]** to enter level set mode.
- ④ Push **[(F-1)▲]** or **[(F-2)▼]** to select the monitor level item.
- ⑤ Adjust monitor gain using the tuning dial.
 - Pushing **[(F-3)DEF]** for 1 sec. sets the selected item to the default value.
- ⑥ Push **[EXIT/SET]** twice to exit level set mode.

- ▨ • Use headphones to prevent feedback.
- ▨ • Set the transmit tone settings to the 0 dB positions to check the unaltered characteristics of transmitter or microphone.

[PHONES] jack

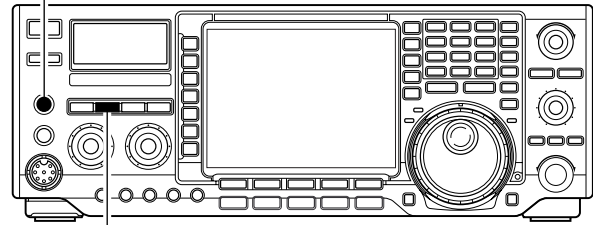

[MONITOR]

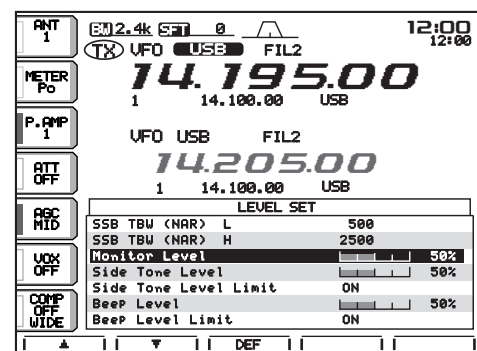

Split frequency operation

Split frequency operation allows you to transmit and receive in the same mode on two different frequencies. The split frequency operation is basically performed using 2 frequencies on the main and sub readouts.

The following is an example of setting 21.290 MHz for receiving and 21.310 MHz for transmitting.

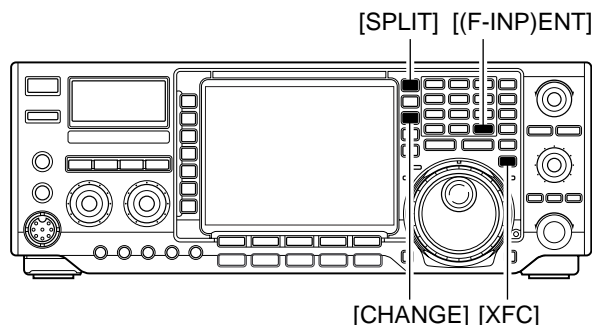

① Set 21.290 MHz (USB) in VFO mode.

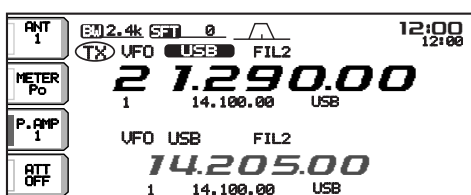

② Push **[SPLIT]** momentarily, then push **[CHANGE]** for 1 sec.

- The quick split function is much more convenient for selecting the transmit frequency. See the next page for details.
- The equalized transmit frequency and “**SPLIT**” appear on the LCD.
- “TX” appears to show the transmit frequency’s readout.

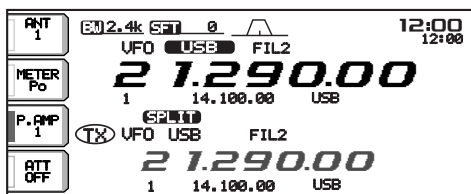

③ Rotate the tuning dial while pushing **[XFC]** to set the transmit frequency to 21.310 MHz.

- The transmit frequency can be monitored while pushing **[XFC]** or using dualwatch.

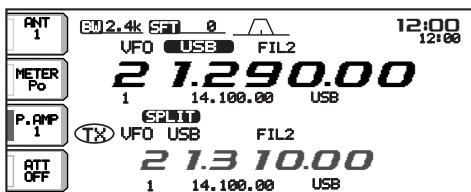

④ Now you can receive on 21.290 MHz and transmit on 21.310 MHz.

To change the transmit and receive frequencies, push **[CHANGE]** to exchange the main and sub readouts.

CONVENIENT

DIRECT SHIFT FREQUENCY INPUT

The shift frequency can be entered directly.

- ① Push **[(F-INP)ENT]**.
- ② Enter the desired shift frequency with the digit keys.
 - 1 kHz to 1 MHz can be set.
 - When you require a minus shift direction, push **[•]** in advance.
- ③ Push **[SPLIT]**.
 - The shift frequency is input in the sub readout and the split function is turned ON.

EXAMPLE

To operate on 1 kHz higher frequency: **[F-INP ENT]** **[1]** **[SPLIT]**

To operate on 3 kHz lower frequency: **[F-INP ENT]** **[•]** **[3]** **[SPLIT]**

CONVENIENT

DUALWATCH FUNCTION

The dualwatch function is convenient for tuning the transmit frequency while monitoring both frequencies used for transmitting and receiving.

CONVENIENT

SPLIT LOCK FUNCTION

Accidentally releasing the **[XFC]** switch while rotating the tuning dial changes the receive frequency. To prevent this, use both the split lock and dial lock functions to change the transmit frequency only. The split lock function cancels the dial lock function while pushing **[XFC]** during split frequency operation.

The dial lock’s effectiveness during split frequency operation can be selected in the set mode for both receive and transmit frequencies; or only the receive frequency. (p. 100)

Quick split function

When you find a DX station, an important consideration is how to set the split frequency.

When you push the **[SPLIT]** switch for 1 sec., split frequency operation is turned ON, the sub readout is equalized to the main readout frequency and enters standby for transmit frequency input.

This shortens the time needed to start split frequency operation.

The quick split function is ON by default. For your convenience, it can be turned OFF in set mode. (p. 100) In this case, the **[SPLIT]** switch does not equalize the main and sub readout frequencies.

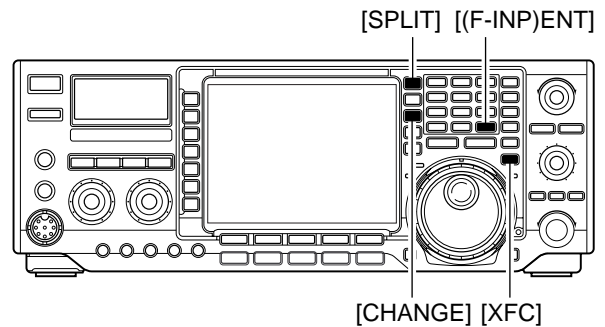

- Suppose you are operating at 21.290 MHz (USB) in VFO mode.

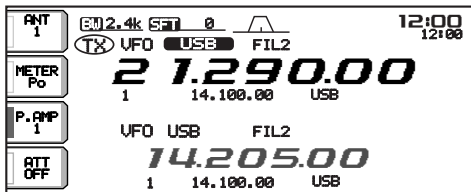

- Push **[SPLIT]** for 1 sec.
 - Split frequency operation is turned ON.
 - The sub readout is equalized to the main readout frequency.
 - The sub readout enters standby for transmit frequency input.

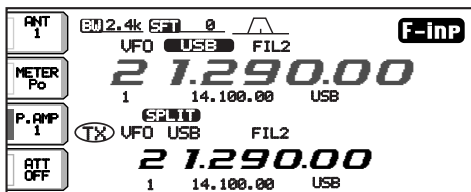

- Rotate the tuning dial to set the transmit frequency; or, input the transmit frequency using the keypad and **[(F-INP)ENT]**; or, input a shift frequency using the keypad and **[SPLIT]**.
 - The transmit frequency can be monitored while pushing **[XFC]** or using dualwatch.

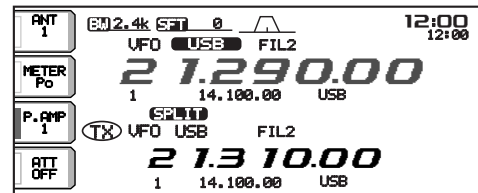

PRACTICAL EXAMPLE

When you are searching for DX stations and you suspect that a DX station may say “up ‘X’ kHz” for their receive frequency:

OPERATION 1

- Push **[SPLIT]** for 1 sec. to standby for split operation.
- If the DX station’s operator says “up 10 kHz”:
 - Push **[1]**, **[0]** then **[SPLIT]**.
 - Or, rotate the tuning dial.

OPERATION 2

If the DX station’s operator says “down 5 kHz” before you enter standby for split operation:

- Push **[(F-INP)ENT]**, **[.]**, **[5]** then **[SPLIT]**.
 - The split function is turned ON and “5 kHz down” frequency is entered in the sub readout.

PRACTICAL EXAMPLE

When you receive a pile-up and you want to start split frequency operation to simplify picking out stations:

- Push **[SPLIT]** momentarily and push **[CHANGE]** for 1 sec.
 - The sub readout frequency is equalized to the main readout frequency and “**SPLIT**” appears.
- Rotate the tuning dial to set your receive frequency in the main readout.
- Announce your receive frequency.
- After you catch one of the calling stations’ call signs, push and hold the PTT switch to respond.
 - While pushing **[XFC]**, you can monitor your transmit frequency.

■ Digital voice recorder

The transceiver has a total of 8 memory channels, 4 each for transmit and receive, of digital voice memories. A maximum message length of 15 sec. can be recorded in each receive channel, and a total message length of 90 sec. can be recorded in transmit channels.

Providing a transmission memory is very convenient for repeated CQ and number transmissions at contest times, as well as when making consecutive calls in DX'pedition.

•Recording a received audio

- ① Push **[EXIT/SET]** several times to close a multi-function screen, if necessary.
- ② Select the desired mode by pushing **[SSB]**, **[CW/RTTY]** or **[AM/FM]**.
- ③ Push **[(F-2)VOICE]** to call up the voice recorder screen.
 - If the transmit voice memory channel (T1–T4) appears, push **[(F-5)T/R]** to select receive voice memory channel.

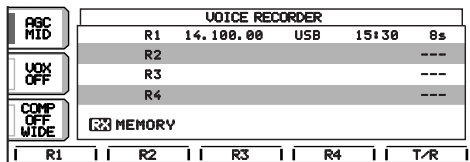

- ④ Push the desired memory channel switch, **[(F-1)R1]–[(F-4)R4]**, for 1 sec. to start recording.
 - “REC” flashes and the recording timer counts up.
 - The operating frequency, mode and current time are programmed as the memory names automatically.
 - Previously recorded contents are cleared.

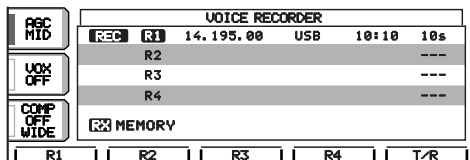

- ⑤ Push the selected memory channel switch, **[(F-1)R1]–[(F-4)R4]**, again to stop recording.
 - Recording is automatically terminated after 30 min.

IMPORTANT!

Push one of **[(F-1)R1]–[(F-4)R4]** to stop recording before, or when 15 sec. has passed from the start of recording.

The voice recorder memory records the 15 sec. (max.) of audio before one of **[(F-1)R1]–[(F-4)R4]** is pushed.

For example, when recording 20 sec. of audio, the first 5 sec. audio will be over-recorded with the last 5 sec., so that the total of audio recorded is 15 sec. only.

- ⑥ Push **[EXIT/SET]** twice to exit the voice memory screen.

•Playing the recorded audio

- ① Push **[EXIT/SET]** several times to close a multi-function screen, if necessary.
- ② Push **[(F-2)VOICE]** to call up the voice recorder screen.
 - If the transmit voice memory channel (T1–T4) appears, push **[(F-5)T/R]** to select receive voice memory channel.

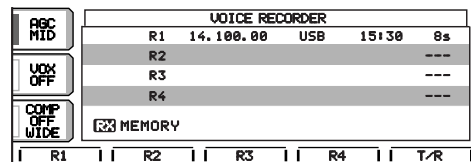

- ③ Push the desired memory channel switch, **[(F-1)R1]–[(F-4)R4]**, momentarily to playback.
 - “PLAY” appears.

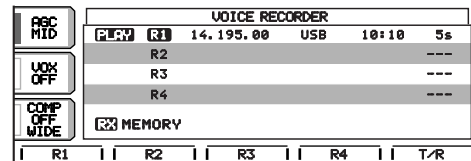

- ④ Push the selected memory channel switch, **[(F-1)R1]–[(F-4)R4]**, again to stop playback if desired.
 - Playback is terminated automatically when all of the recorded contents in the channel are played, or after 15 sec.
- ⑤ Push **[EXIT/SET]** twice to exit the voice memory screen.

■ Digital voice recorder (continued)

• One-touch voice recording

To record the receiving signal contents immediately, one-touch voice recording is available.

- ① Push **[REC/PLAY]** for 1 sec. while receiving a signal to start recording.
 - “REC” flashes.
 - Records audio into the channel R4.
- ② Push **[REC/PLAY]** momentarily to stop recording.
 - Recording is automatically terminated after 30 min.

/// **IMPORTANT!**

Push **[REC/PLAY]** to stop recording before, or when 15 sec. has passed from the start of recording.

• One-touch playback

The recorded audio in the channel R4 can be played back without selecting the voice memory screen.

- ① Push **[REC/PLAY]** to playback.
 - “PLAY” appears.
 - Playback the recorded audio in the channel R4.
- ② Push **[REC/PLAY]** again to stop playback if desired.
 - Playback is terminated automatically when all of the recorded contents in the channel R4 are played, or after 15 sec.

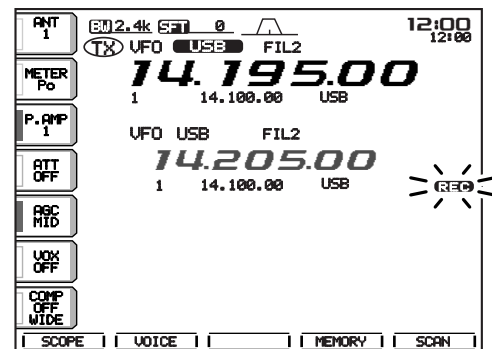
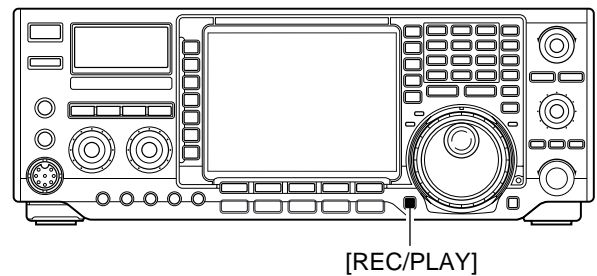

Digital voice recorder (continued)

Recording a message for transmit

To transmit a message using a voice recorder, record the desired message in advance as described below.

- Push **[EXIT/SET]** several times to close a multi-function screen, if necessary.
- Push **[(F-2)VOICE]** to call up the voice recorder screen.

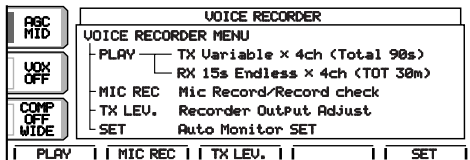

- Push **[(F-2)MIC REC]** to select the voice memory recording screen.

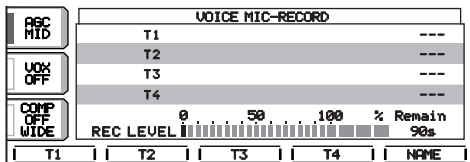

- Push the desired memory channel switch, **[(F-1)T1]–[(F-4)T4]**, for 1 sec. to start recording.
 - Speak into the microphone without pushing the **[PTT]** switch.
 - Previously recorded contents are cleared.

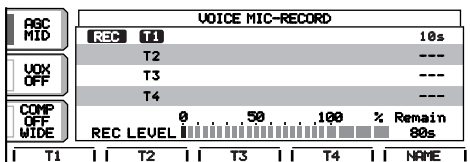

- Adjust the **[MIC GAIN]** control so that the **[REC LEVEL]** indicator reads within 100%.
- Push the selected memory channel switch, **[(F-1)T1]–[(F-4)T4]**, again to stop recording.
 - Recording is automatically terminated when the total time of recorded messages, T1–T4, becomes 90 sec.
- Push **[EXIT/SET]** twice to exit the voice memory screen.

Confirming a message for transmit

- Push **[EXIT/SET]** several times to close a multi-function screen, if necessary.
- Push **[(F-2)VOICE]** to call up the voice recorder screen.
- Push **[(F-2)MIC REC]** to select the voice memory recording screen.

- Push the desired memory channel switch, **[(F-1)T1]–[(F-4)T4]**, momentarily to start playback and confirmation.

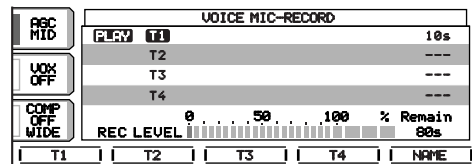

- Push the selected memory channel switch, **[(F-1)T1]–[(F-4)T4]**, again to stop playback if desired.
- Push **[EXIT/SET]** twice to exit the voice memory screen.

Programming a memory name for transmit

Memory channels can be tagged with alphanumeric names of up to 20 characters each.

Capital letters, small letters, numerals, some symbols (! # \$ % & ¥ ? " ' ` ^ + - * / . : ; = < > () [] { } | _ - @) and spaces can be used. (See step ⑤ below.)

- Record a message as described at left.
- Call up the voice memory recording screen as described in steps ① to ③ at left.
- Push **[(F-5)NAME]** to enter memory name edit condition.
 - A cursor appears and blinks.
- Push **[(F-5)T1..T4]** several times to select the desired voice memory.

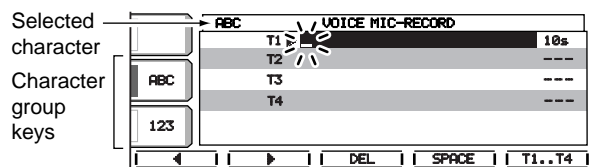

- Input the desired character by rotating the tuning dial or by pushing the band key for number input.
 - Push **[ABC]** or **[abc]** to toggle capital and small letters.
 - Push **[123]** or **[etc]** to toggle numerals and symbols.
 - Push **[(F-1)◀]** or **[(F-2)▶]** for cursor movement.
 - Push **[(F-3)DEL]** to delete the selected character.
 - Push **[(F-4)SPACE]** to input a space.
 - Pushing the transceiver's keypad, **[0]–[9]**, can also enter numerals.
- Push **[EXIT/SET]** to input and set the name.
 - The cursor disappears.
- Repeat steps ④ to ⑥ to program another voice memory's name, if desired.
- Push **[EXIT/SET]** twice to exit the voice memory screen.

■ Digital voice recorder (continued)

• Sending a message for transmit

- ① Push **[EXIT/SET]** several times to close a multi-function screen, if necessary.
- ② Select a phone mode by pushing **[SSB]** or **[AM/FM]**.
- ③ Push **[(F-2)VOICE]** to call up the voice recorder screen.
 - If the receive voice memory channel (R1–R4) appears, push **[(F-5)T/R]** to select transmit voice memory channel.

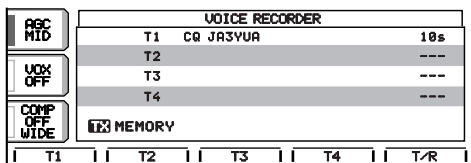

- ④ Push the desired memory channel switch, **[(F-1)T1]–[(F-4)T4]**, momentarily to transmit the contents.

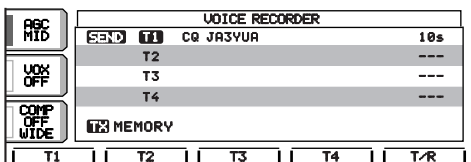

- ⑤ Push the selected memory channel switch, **[(F-1)T1]–[(F-4)T4]**, again to stop, if desired.
- ⑥ Push **[EXIT/SET]** twice to exit the voice memory screen.

/// For your information

When an external keypad is connected to the pin 3 and pin 7 of the **[MIC]** connector, the recorded message, T1–T4, can be transmitted without opening the voice recorder set screen.
See page 104 for details.

• Transmit monitor function

The monitor function can be automatically turned ON while transmitting a voice memory message.

- ① Call up the voice recorder screen as described at left.
- ② Push **[EXIT/SET]** then **[(F-5)SET]** to select the voice recorder set screen.
- ③ Rotate the tuning dial to turn the monitor function ON and OFF.
 - Push **[(F-3)DEF]** for 1 sec. to select the default condition.

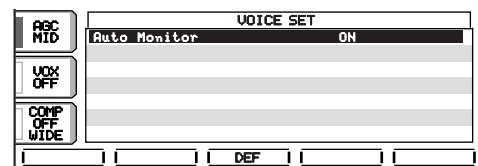

- ④ Push **[EXIT/SET]** to return to the voice recorder screen.

• Transmit level setting

- ① Call up the voice recorder screen as described at left.
- ② Push **[(F-3)TX LEV.]** to select the voice memory transmit level set mode screen.

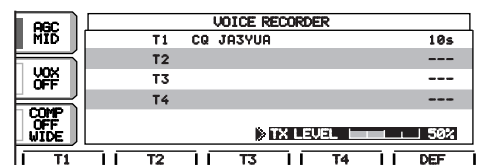

- ③ Push the desired memory channel switch, **[(F-1)T1]–[(F-4)T4]**, momentarily to transmit the contents.
- ④ Rotate the tuning dial to adjust the transmit voice level.
 - Push **[(F-5)DEF]** to select the default condition.

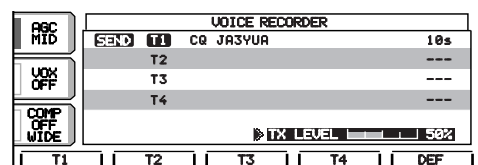

- ⑤ Push **[EXIT/SET]** to return to the voice recorder screen.

Memory channels

The transceiver has 101 memory channels. The memory mode is very useful for quickly changing to often-used frequencies.

All 101 memory channels are tuneable which means the programmed frequency can be tuned temporarily with the tuning dial, etc. in memory mode.

MEMORY CHANNEL	MEMORY CHANNEL NUMBER	CAPABILITY	TRANSFER TO VFO	OVER-WRITING	CLEAR
Regular memory channels	1–99	One frequency and one mode in each memory channel.	Yes	Yes	Yes
Scan edge memory channels	P1, P2	One frequency and one mode in each memory channel as scan edges for programmed scan.	Yes	Yes	No

Memory channel selection

Using the [▲] or [▼] keys

- Push [VFO/MEMO] to select memory mode.
- Push [▲]/[▼] several times to select the desired memory channel.
 - Push and hold [▲]/[▼] for continuous selection.
 - [UP] and [DN] on the microphone can also be used.
- To return to VFO mode, push [VFO/MEMO] again.

Using the keypad

- Push [VFO/MEMO] to select memory mode.
- Push [(F-INP)ENT].
- Push the desired memory channel number using the keypad.
 - Enter 100 or 101 to select scan edge channel P1 or P2, respectively.
- Push [▲] or [▼] to select the desired memory channel.

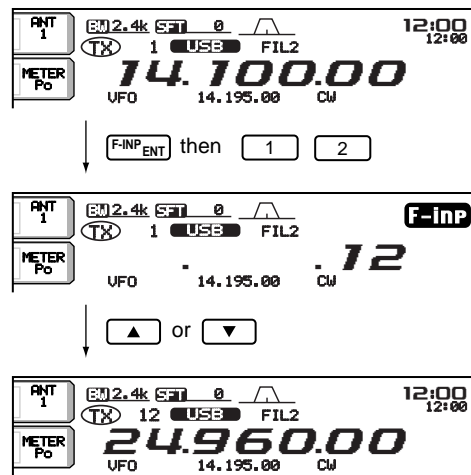
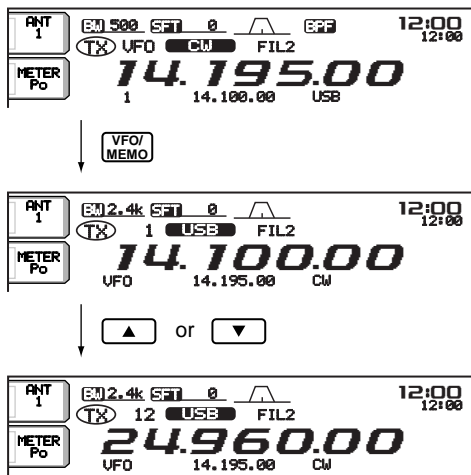

Memory channel screen

The memory channel screen simultaneously shows 7 memory channels and their programmed contents. 13 memory channels can be displayed in the wide memory channel screen.

You can select a desired memory channel from the memory channel screen.

•Selecting a memory channel using the memory channel screen

- ① Push **[EXIT/SET]** several times to close a multi-function screen, if necessary.
- ② Push **[(F-4)MEMORY]** to select the memory channel screen.
• **[(F-5)WIDE]** switches the standard and wide screens.

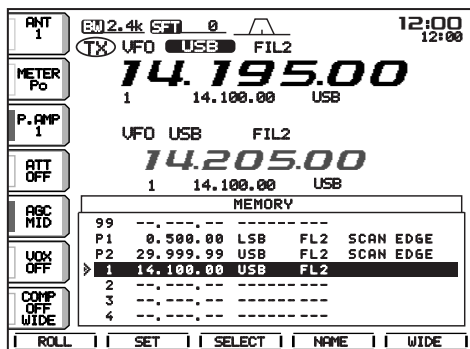

- ③ Rotate the tuning dial while pushing **[(F-2)SET]** to select the desired memory channel.
• **[▲]** and **[▼]** can also be used.
- ④ Push **[EXIT/SET]** to exit the memory channel screen.

•Confirming programmed memory channels

- ① Select the memory channel screen as described above.
- ② Rotate the tuning dial while pushing **[(F-1)ROLL]** to scroll the screen.
- ③ Push **[(F-2)SET]** to select the highlighted memory channel, if desired.

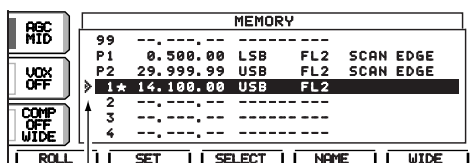

"▶" appears when the memory channel is selected.

- ④ Push **[EXIT/SET]** to exit the memory channel screen.

•Setting a memory channel as a select memory

Select memory channels are used for select memory scan. Select memory scan repeatedly scans the select memory channels only. This is useful to speed up the memory scan interval. Of course, select memory channels are also scanned during normal memory scan.

- ① Select the memory channel screen as described at left.
- ② Rotate the tuning dial while pushing **[(F-1)ROLL]** or **[(F-2)SET]** to select the desired memory channel.
• **[▲]** and **[▼]** can also be used.
- ③ Push **[(F-3)SELECT]** to set the memory channel as a select memory or not.

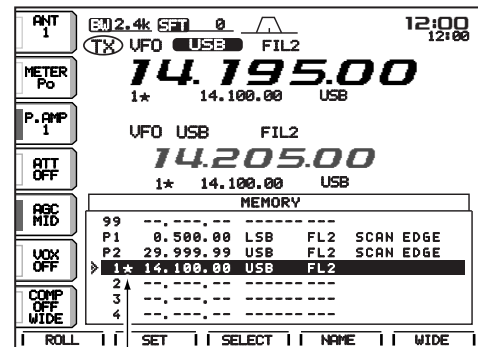

"★" appears for select memory channel.

- ④ Repeat steps ② to ③ to program another memory channel as a select memory channel, if desired.
- ⑤ Push **[EXIT/SET]** to exit the memory channel screen.

Setting select memory channels is also possible in the scan screen.

Memory channel programming

Memory channel programming can be preformed either in VFO mode or in memory mode.

• Programming in VFO mode

- ① Set the desired frequency and operating mode in VFO mode.
- ② Push **[▲]/[▼]** several times to select the desired memory channel.
 - Memory channel screen is convenient for selecting the desired channel.
 - Memory channel contents appear in the memory channel readout (below the frequency readout).
 - “--.--” appears if the selected memory channel is a blank channel (and does not have contents).
- ③ Push **[MW]** for 1 sec. to program the displayed frequency and operating mode into the memory channel.

[EXAMPLE]: Programming 7.088 MHz/LSB into memory channel 12.

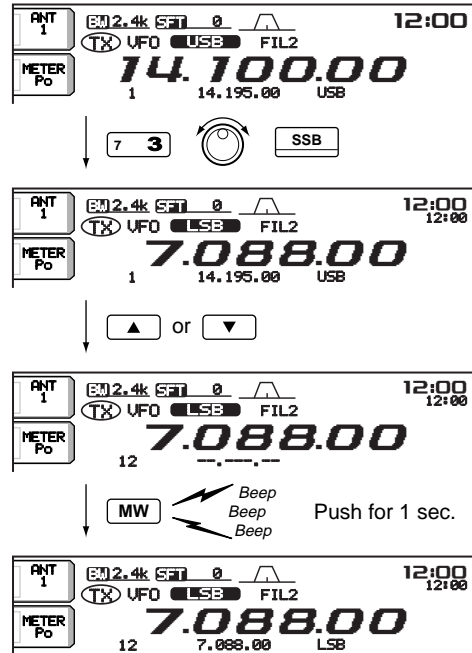

• Programming in memory mode

- ① Select the desired memory channel with **[▲]/[▼]** in memory mode.
 - Memory channel contents appear in the memory channel readout (below the frequency readout).
 - “--.--” appears if the selected memory channel is a blank channel (and does not have contents).
- ② Set the desired frequency and operating mode in memory mode.
 - To program a blank channel, use direct frequency entry with the keypad or memo pads, etc.
- ③ Push **[MW]** for 1 sec. to program the displayed frequency and operating mode into the memory channel.

[EXAMPLE]: Programming 21.280 MHz/USB into memory channel 18.

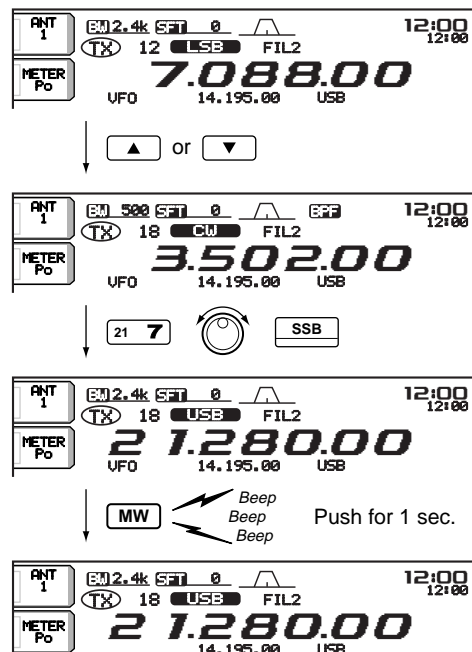

Frequency transferring

The frequency and operating mode in a memory channel can be transferred to the VFO.

Frequency transferring can be performed in either VFO mode or memory mode.

Transferring in VFO mode

This is useful for transferring programmed contents to VFO.

- ① Select VFO mode with **[VFO/MEMO]**.
- ② Select the memory channel to be transferred with **[▲]/[▼]**.
 - Memory channel screen is convenient for selecting the desired channel.
 - Memory channel contents appear in the memory channel readout (below the frequency readout).
 - “---.---.---” appears if the selected memory channel is a blank channel. In this case transferring is impossible.
- ③ Push **[VFO/MEMO]** for 1 sec. to transfer the frequency and operating mode.
 - Transferred frequency and operating mode appear on the frequency readout.

TRANSFERRING EXAMPLE IN VFO MODE

Operating frequency : 21.320 MHz/USB (VFO)
 Contents of M-ch 16 : 14.018 MHz/CW

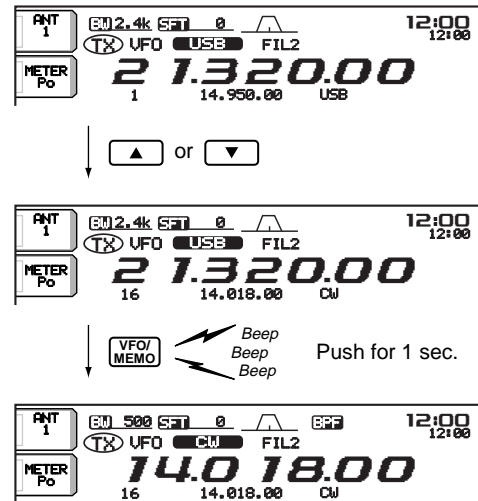

Transferring in memory mode

This is useful for transferring frequency and operating mode while operating in memory mode.

- When you have changed the frequency or operating mode in the selected memory channel:
 - **Displayed** frequency and mode are transferred.
 - **Programmed** frequency and mode in the memory channel are not transferred, and they remain in the memory channel.

- ① Select the memory channel to be transferred with **[▲]/[▼]** in memory mode.
 - And, set the frequency or operating mode if required.
- ② Push **[VFO/MEMO]** for 1 sec. to transfer the frequency and operating mode.
 - Displayed frequency and operating mode are transferred to the VFO.
- ③ To return to VFO mode, push **[VFO/MEMO]** momentarily.

TRANSFERRING EXAMPLE IN MEMORY MODE

Operating frequency : 14.020 MHz/CW (M-ch 16)
 Contents of M-ch 16 : 14.018 MHz/CW

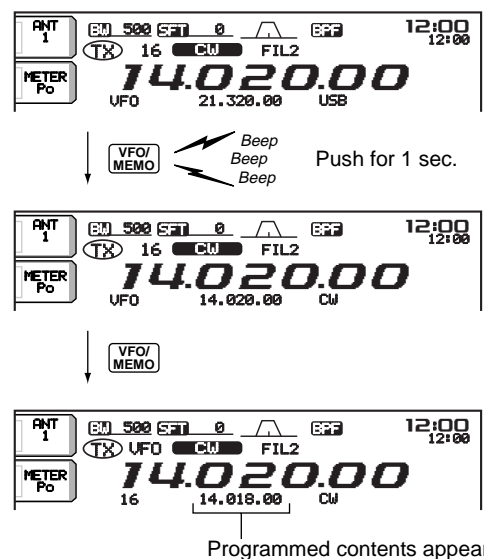

Programmed contents appear.

Memory names

All memory channels (including scan edges) can be tagged with alphanumeric names of up to 10 characters each.

Capital letters, small letters, numerals, some symbols (! # \$ % & ¥ ? " ' ` ^ + - * / . : ; = < > () [] { } | _ ~) and spaces can be used.

Editing (programming) memory names

- ① Push **[EXIT/SET]** several times to close a multi-function screen, if necessary.
- ② Push **[(F-4)MEMORY]** to select the memory channel screen.

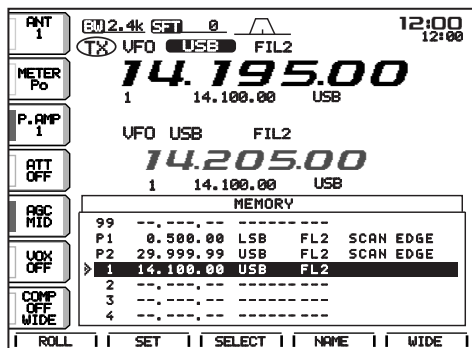

- ③ Select the desired memory channel.

- ④ Push **[(F-4)NAME]** to edit memory channel name.
 - A cursor appears and blinks.
 - Memory channel names of blank channels cannot be edited.

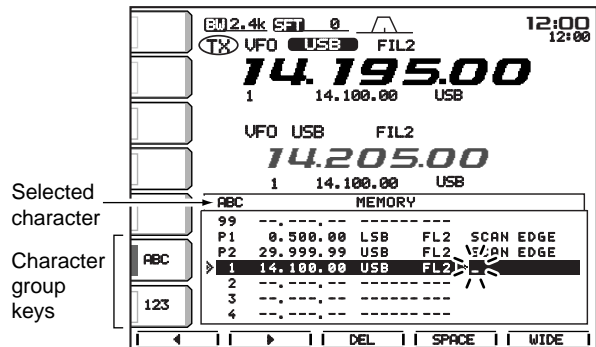

- ⑤ Input the desired character by rotating the tuning dial or by pushing the band key for number input.
 - Push **[ABC]** or **[abc]** to toggle capital and small letters.
 - Push **[123]** or **[etc]** to toggle numerals and symbols.
 - Push **[(F-1)◀]** or **[(F-2)▶]** for cursor movement.
 - Push **[(F-3)DEL]** to delete the selected character.
 - Push **[(F-4)SPACE]** to input a space.
 - Pushing the transceiver's keypad, **[0]–[9]**, can also enter numerals.
- ⑥ Push **[EXIT/SET]** to input and set the name.
 - The cursor disappears.
- ⑦ Repeat steps ③ to ⑥ to program another memory channel's name, if desired.
- ⑧ Push **[EXIT/SET]** to exit the memory channel screen.

Memory clearing

Any unnecessary memory channels can be cleared. The cleared memory channels become blank channels.

- ① Select memory mode with **[VFO/MEMO]**.
- ② Select the desired memory channel with **[▲]/[▼]**.
- ③ Push **[M-CL]** for 1 sec. to clear the contents.
 - The programmed frequency and operating mode disappear.
- ④ To clear other memory channels, repeat steps ② and ③.

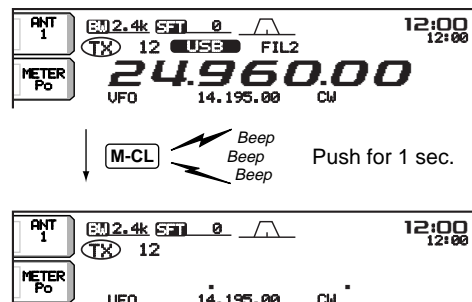

■ Memo pads

The transceiver has a memo pad function to store frequency and operating mode for easy write and recall. The memo pads are separate from memory channels.

The default number of memo pads is 5, however, this can be increased to 10 in set mode if desired. (p. 102)

Memo pads are convenient when you want to memorize a frequency and operating mode temporarily, such as when you find a DX station in a pile-up, or when a desired station is busy for a long time and you want to temporarily search for other stations.

Use the transceiver's memo pads instead of relying on hastily scribbled notes that are easily misplaced.

• Writing frequencies and operating modes into memo pads

You can simply write the accessed readout frequency and operating mode by pushing [MP-W].

When you write a 6th frequency and operating mode, the oldest written frequency and operating mode are automatically erased to make room for the new settings.

Each memo pad must have its own unique combination of frequency and operating mode; memo pads having identical settings cannot be written.

Displayed frequency and mode

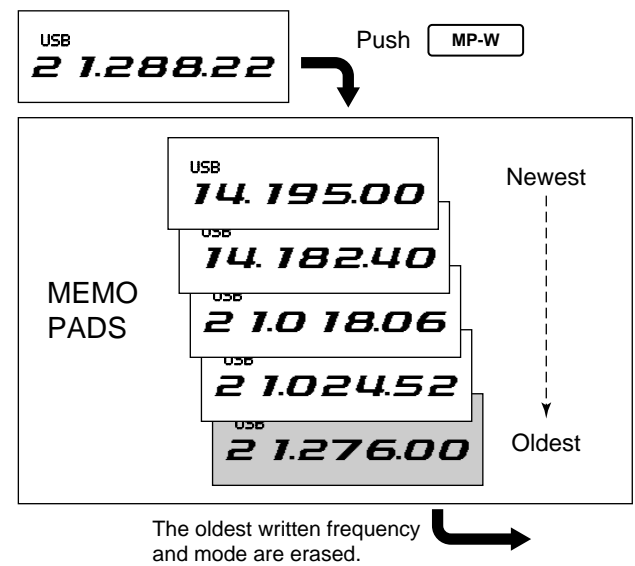

• Calling up a frequency from a memo pad

You can simply call up the desired frequency and operating mode of a memo pad by pushing [MP-R] several times.

- Both VFO and memory modes can be used.
- The frequency and operating mode are called up, starting from the most recently written.

When you call up a frequency and an operating mode from memo pads with [MP-R], the previously displayed frequency and operating mode are automatically stored in a temporary pad. The frequency and operating mode in the temporary pad can be recalled by pushing [MP-R] several times.

- You may think there are 6 memo pads because 6 different frequencies (5 are in memo pads and 1 is in the temporary pad) are called up by [MP-R].

If you change the frequency or operating mode called up from a memo pad with the tuning dial, etc., the frequency and operating mode in the temporary pad are erased.

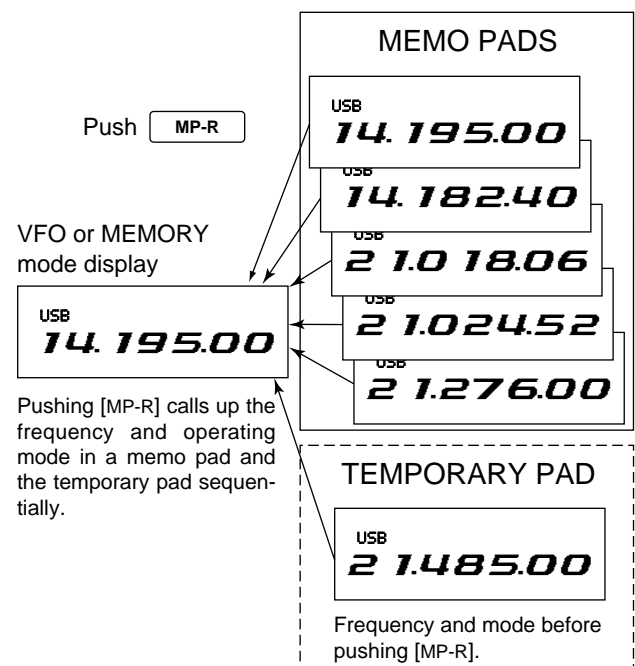

Scan types

- The scan function can be used on the main readout only.
- You can operate a scan while operating on a frequency using the dualwatch or split functions. See p. 63 for details.

PROGRAMMED SCAN

Repeatedly scans between two scan edge frequencies (scan edge memory channels P1 and P2).

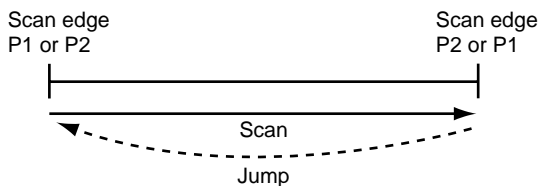

This scan operates in VFO mode.

ΔF SCAN

Repeatedly scans within ΔF span area.

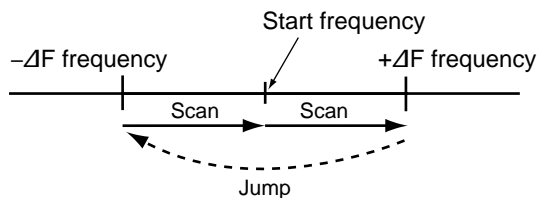

This scan operates in both VFO and memory modes.

MEMORY SCAN

Repeatedly scans all programmed memory channels.

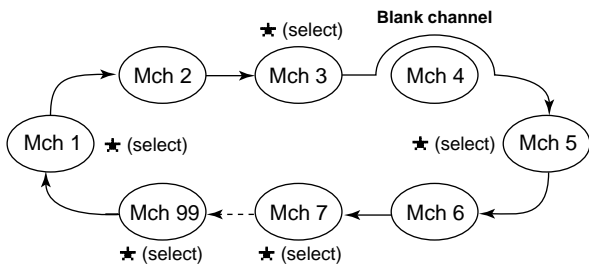

This scan operates in memory mode.

SELECT MEMORY SCAN

Repeatedly scans all select memory channels.

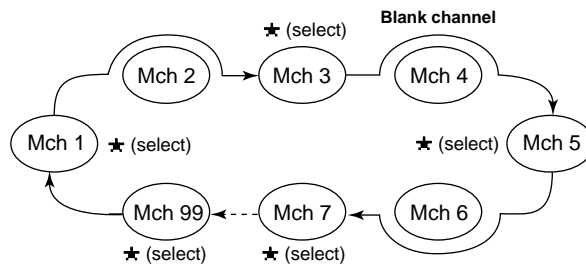

This scan operates in memory mode.

Preparation

Channels

For programmed scan:

Program scan edge frequencies into scan edge memory channels P1 and P2.

For ΔF scan:

Set the ΔF span (ΔF scan range) in the scan screen.

For memory scan:

Program 2 or more memory channels except scan edge memory channels.

For select memory scan:

Designate 2 or more memory channels as select memory channels. To designate the channel as a select memory channel, choose a memory channel, then push **[(F-3)SELECT]** in the scan screen (memory mode) or in the memory channel screen.

Scan resume ON/OFF

You can select the scan to resume or cancel when detecting a signal, in set mode. Scan resume ON/OFF must be set before operating a scan. See p. 87 for ON/OFF setting and scan resume condition details.

Scan speed

Scan speed can be selected from 2 levels, high or low, in set mode. See p. 87 for details.

Squelch condition

SCAN STARTS WITH	PROGRAMMED SCAN	MEMORY SCAN
SQUELCH OPEN	The scan continues until it is stopped manually, and does not pause even if it detects signals.	Scan pauses on each channel when the scan resume is ON; not applicable when OFF.
SQUELCH CLOSED	Scan stops when detecting a signal. If you set scan resume ON in set mode, the scan pauses for 10 sec. when detecting a signal, then resumes. When a signal disappears while scan is paused, scan resumes 2 sec. later.	

Programmed scan operation

- ① Push **[EXIT/SET]** several times to close a multi-function screen, if necessary.
- ② Select VFO mode.
- ③ Select the desired operating mode.
 - The operating mode can also be changed while scanning.
- ④ Push **[(F-5)SCAN]** to select the scan screen.

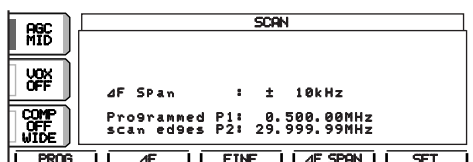

- ⑤ Set **[RF/SQL]** open or closed.
 - See previous page for scan condition.
 - If the **[RF/SQL]** control function is set as "AUTO," the squelch is always open in SSB, CW and RTTY modes. See pgs. 2, 30, 99 for details.

- ⑥ Push **[(F-1)PROG]** to start the programmed scan.
 - Decimal points blink while scanning.

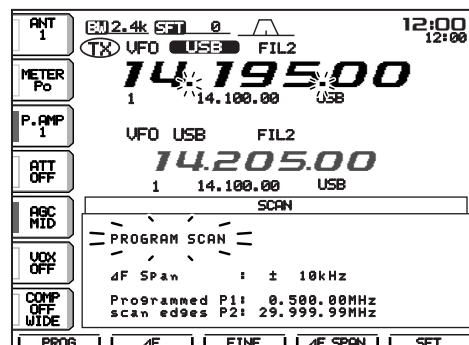

- ⑦ When the scan detects a signal, the scan stops, pauses or ignores it depending on the resume setting and the squelch condition.
- ⑧ To cancel the scan, push **[(F-1)PROG]**.

▨ If the same frequencies are programmed into the scan edge memory channel P1 and P2, programmed scan does not start.

ΔF scan operation

- ① Push **[EXIT/SET]** several times to close a multi-function screen, if necessary.
- ② Select VFO mode or a memory channel.
- ③ Select the desired operating mode.
 - The operating mode can also be changed while scanning.
- ④ Push **[(F-5)SCAN]** to select the scan screen.

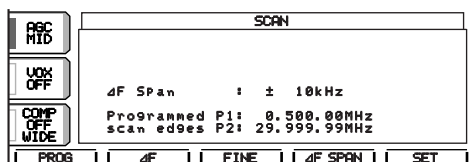

- ⑤ Set **[RF/SQL]** open or closed.
 - See previous page for scan condition.
 - If the **[RF/SQL]** control function is set as "AUTO," the squelch is always open in SSB, CW and RTTY modes. See pgs. 2, 30, 99 for details.
- ⑥ Set the ΔF span by pushing **[(F-4)ΔF SPAN]**.
 - ±5 kHz, ±10 kHz, ±20 kHz, ±50 kHz, ±100 kHz, ±500 kHz and ±1000 kHz are selectable.
- ⑦ Set center frequency of the ΔF span.

- ⑧ Push **[(F-2)ΔF]** to start the ΔF scan.
 - Decimal points blink while scanning.

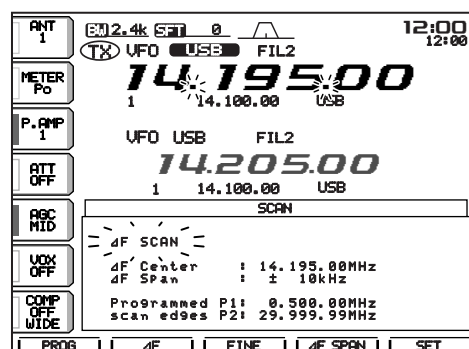

- ⑨ When the scan detects a signal, the scan stops, pauses or ignores it depending on the resume setting and the squelch condition.
- ⑩ To cancel the scan, push **[(F-2)ΔF]**.

■ Fine programmed scan/fine ΔF scan

Fine scan functions as programmed or ΔF scan, but scan speed decreases when the squelch opens but does not stop. The scanning tuning step shifts from 50 Hz to 10 Hz while the squelch opens.

- ① Push **[EXIT/SET]** several times to close a multi-function screen, if necessary.
- ② Push **[(F-5)SCAN]** to select the scan screen.
- ③ Set for programmed scan or ΔF scan as described on previous page.
- ④ Push **[(F-1)PROG]** or **[(F-2)ΔF]** to start a scan.
 - Decimal points blink while scanning.

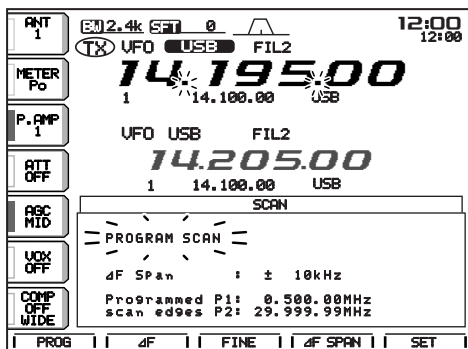

- ⑤ Push **[(F-3)FINE]** to start a fine scan.
 - “FINE PROGRAM SCAN” or “FINE ΔF SCAN” appears.

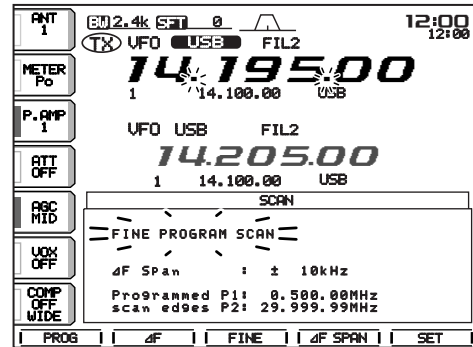

- ⑥ When the scan detects a signal, the scan speed decreases but does not stop.
- ⑦ Push **[(F-1)PROG]** or **[(F-2)ΔF]** to stop the scan; push **[(F-3)FINE]** to cancel the fine scan.

■ Memory scan operation

- ① Push **[EXIT/SET]** several times to close a multi-function screen, if necessary.
- ② Select memory mode.
- ③ Push **[(F-5)SCAN]** to select the scan screen.

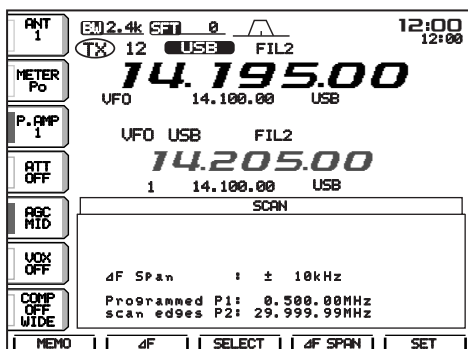

- ④ Set **[RF/SQL]** open or closed.
 - See p. 83 for scan condition.
 - If the **[RF/SQL]** control function is set as “AUTO,” the squelch is always open in SSB, CW and RTTY modes. See pgs. 2, 30, 99 for details.

- ⑤ Push **[(F-1)MEMO]** to start the memory scan.
 - Decimal points blink while scanning.

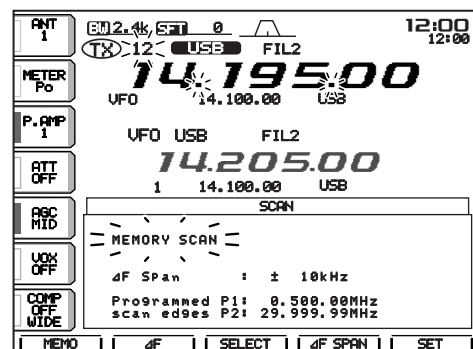

- ⑥ When the scan detects a signal, the scan stops, pauses or ignores it depending on the resume setting and the squelch condition.
- ⑦ To cancel the scan, push **[(F-1)MEMO]**.

2 or more memory channels must be programmed for memory scan to start.

Select memory scan operation

- ① Push **[EXIT/SET]** several times to close a multi-function screen, if necessary.
- ② Select memory mode.
- ③ Push **[(F-5)SCAN]** to select the scan screen.

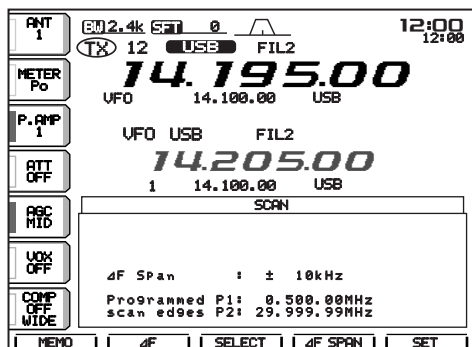

- ④ Set **[RF/SQL]** open or closed.
 - See p. 83 for scan condition.
 - If the **[RF/SQL]** control function is set as "AUTO," the squelch is always open in SSB, CW and RTTY modes. See pgs. 2, 30, 99 for details.
- ⑤ Push **[(F-1)MEMO]** to start the memory scan.
 - Decimal points blink while scanning.

- ⑥ Push **[(F-3)SELECT]** to start select memory scan; push **[(F-3)SELECT]** again to return to memory scan, if desired.

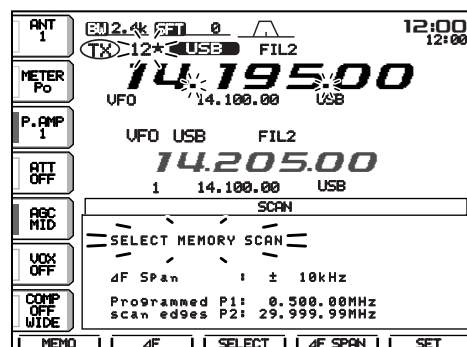

- ⑦ When the scan detects a signal, the scan stops, pauses or ignores it depending on the resume setting and the squelch condition.
- ⑧ To cancel the scan, push **[(F-1)MEMO]**.

2 or more memory channels must be designated as select memory channels for select memory scan to start.

Setting select memory channels

- ① Push **[EXIT/SET]** several times to close a multi-function screen, if necessary.
- ② Select memory mode.
- ③ Push **[(F-5)SCAN]** to select the scan screen.

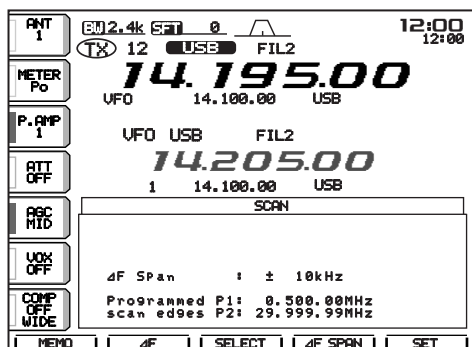

- ④ Select the desired memory channel to set as a select memory channel.

- ⑤ Push **[(F-3)SELECT]** to set the memory channel as a select memory or not.

"★" appears for select memory channels.

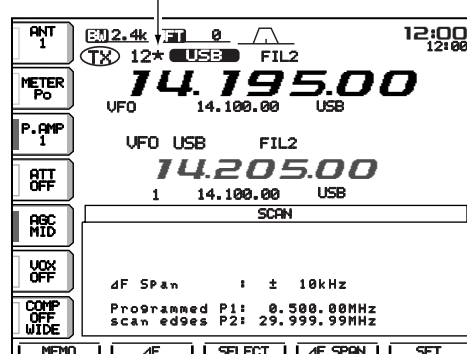

- ⑥ Repeat steps ④ to ⑤ to program another memory channel as a select memory channel, if desired.
- ⑦ Push **[EXIT/SET]** to exit the scan screen.

Select memory channels can also be set in the memory channel screen. (p. 78)

■ Scan set mode

Scan set mode is used for programming scanning speed and scan resume condition.

• Scan speed

The transceiver has 2 speeds for scanning, high and low.

- ① Push **[EXIT/SET]** several times to close a multi-function screen, if necessary.
- ② Push **[(F-5)SCAN]** to select the scan screen.

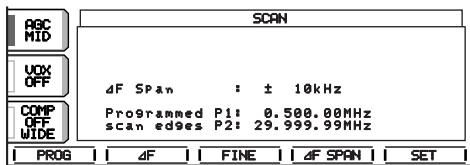

- ③ Push **[(F-5)SET]** to select the scan set mode screen.
- ④ Push **[(F-1)▲]** to select the scan speed item.

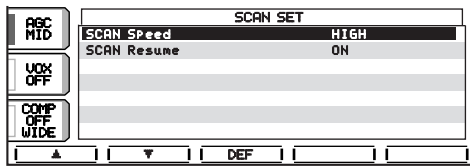

- ⑤ Rotate the tuning dial to select the scan speed.
 - Push **[(F-3)DEF]** to select the default condition.
- ⑥ Push **[EXIT/SET]** to exit the scan set mode.

• Scan resume condition

This item sets the scan resume function ON or OFF. ON: scan resumes 10 sec. after stopping on a signal (or 1 sec. after a signal disappears); OFF: scan does not resume after stopping on a signal.

- ① Push **[EXIT/SET]** several times to close a multi-function screen, if necessary.
- ② Push **[(F-5)SCAN]** to select the scan screen.
- ③ Push **[(F-5)SET]** to select the scan set mode screen.
- ④ Push **[(F-2)▼]** to select the scan resume condition item.

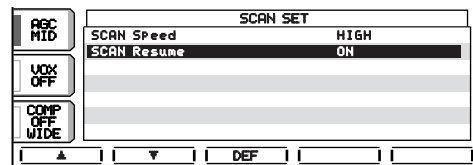

- ⑤ Rotate the tuning dial to turn the scan resume function ON or OFF.
 - Push **[(F-3)DEF]** to select the default condition.
- ⑥ Push **[EXIT/SET]** to exit the scan set mode.

■ Tone scan

The transceiver can detect the subaudible tone frequency in a received signal. By monitoring a signal that is being transmitted on a repeater input frequency, you can determine the tone frequency required to access the repeater.

- ① Set the desired frequency or memory channel to be checked for a tone frequency.
- ② Push **[AM/FM]** several times to select FM mode.
- ③ Push **[TONE]** for 1 sec. to enter the tone frequency screen.

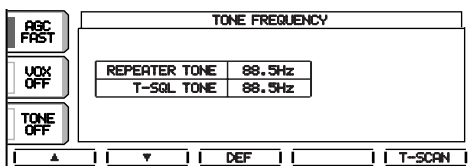

- ④ Push **[(F-1)▲]** or **[(F-2)▼]** to check the repeater tone frequency or tone squelch frequency, respectively. (pgs. 52, 53)

- ⑤ Push **[(F-5)T-SCAN]** to start the tone scan.
 - “SCAN” flashes while scanning.

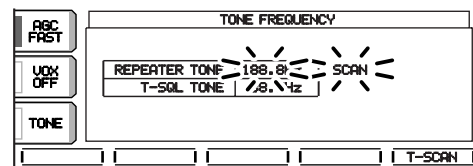

- ⑥ When the tone frequency is detected, the tone scan pauses.
 - The tone frequency is set temporarily on a memory channel. Program into the memory channel to store the tone frequency permanently.
 - The decoded tone frequency is used for the repeater tone frequency or tone squelch frequency.
- ⑦ To stop the scan, push **[(F-5)T-SCAN]**.
- ⑧ Push **[EXIT/SET]** to exit the tone frequency screen.

■ Automatic antenna selection

The transceiver covers 0.1–60 MHz over 10 bands. Each band key has a band memory which can memorize a selected antenna (ANT1, ANT2, ANT1/RX antenna and ANT2/RX antenna). When you change the operating frequency beyond a band, the previously used antenna is automatically selected for the new band. This function is convenient when you use 2 or 3 antennas.

To use the band memory, enter set mode and confirm that “Auto” is selected as the [ANT] switch item. (p. 101)

OTHERS SET	
AGC MID	FM SPLIT Offset(HF) -0.100MHz
	FM SPLIT Offset(50H) -0.500MHz
UDX OFF	SPLIT LOCK OFF
	Tuner (Auto Start) OFF
	Tuner (PTT Start) OFF
COMP OFF WIDE	ANT1 Switch Auto
	RTTY Mark Frequency 2125

- When OFF is selected, the [ANT] switch does not function and [ANT1] is always selected.
- When “Manual” is selected, the [ANT] switch functions, however, band memory does not function. In this case, you must select an antenna manually.
- When “Auto” is selected (default setting), the antenna tuner ON/OFF condition is also memorized in the band memory.
- When “Auto” or “Manual” is selected, the antenna tuner ON/OFF condition is consistent with the [ANT] switch.

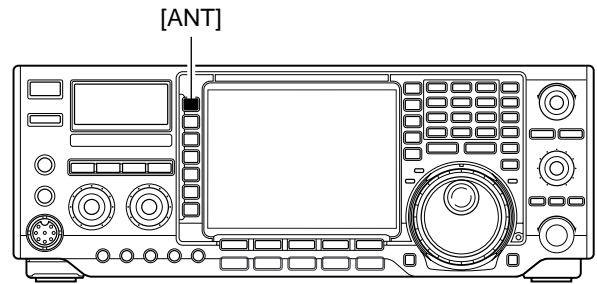

• Antenna switch selection example

Under the following condition, “Auto” should be selected as the [ANT] switch set mode item.

- When you use 2 antennas.

Under the following conditions, “Manual” should be selected as the [ANT] switch set mode item.

- When using 1 antenna.
- When using an external antenna selector for more than 3 antennas (except for receive antenna).
- When using an external antenna tuner.

■ Antenna tuner operation

The internal automatic antenna tuner matches the transceiver to the connected antenna automatically. Once the tuner matches an antenna, the variable capacitor angles are memorized as a preset point for each frequency range (100 kHz steps). Therefore, when you change the frequency range, the variable capacitors are automatically preset to the memorized point.

CAUTION: NEVER transmit with the tuner ON when no antenna is connected. This will damage the transceiver. Be careful of the antenna selection.

TUNER OPERATION

- ➔ Push the **[TUNER]** switch to turn the internal antenna tuner ON. The antenna is tuned automatically when the antenna SWR is higher than 1.5:1.
 - When the tuner is ON, the **[TUNER]** switch lights.

[TUNER]

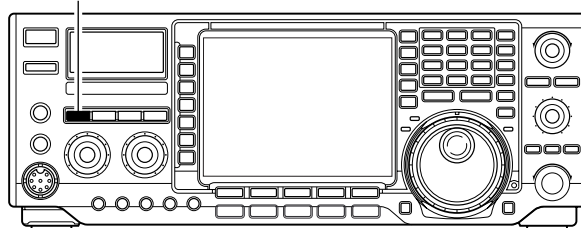

MANUAL TUNING

During SSB operation at low voice levels, the internal tuner may not be tuned correctly. In such cases, manual tuning is helpful.

- ➔ Push **[TUNER]** for 1 sec., to start manual tuning.
 - A side tone is emitted and **[TUNER]** blinks while tuning.
 - If the tuner cannot reduce the SWR to less than 1.5:1 after 20 sec. of tuning, the **[TUNER]** switch indicator goes out.

Push **[TUNER]** for 1 sec.

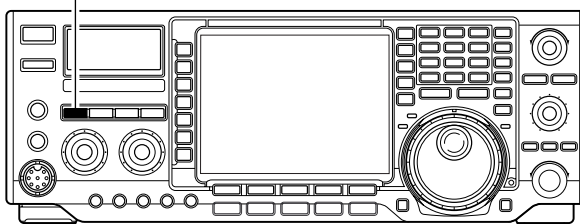

AUTOMATIC TUNER START (HF bands only)

If you want to deactivate the tuner under conditions of VSWR 1.5:1 or less, use the auto tuner start function and turn the tuner OFF. This function activates the tuner automatically when the SWR exceeds 1.5:1.

This function is turned ON in set mode. (p. 101).

PTT TUNER START

The tuner is always tuned when the PTT is pushed after the frequency is changed (more than 1% from last-tuned frequency). This function removes the “push and hold **[TUNER]**” operation and activates for the first transmission on a new frequency.

This function is turned ON in set mode. (p. 101).

NOTES:

•If the tuner cannot tune the antenna

Check the following and try again:

- the **[ANT]** connector selection.
- the antenna connection and feedline.
- the unaltered antenna SWR. (Less than 3:1 for HF bands; Less than 2.5:1 for 50 MHz band)
- the transmit power. (8 W for HF bands; 15 W for 50 MHz band)
- the power source voltage/capacity.

If the tuner cannot reduce the SWR to less than 1.5:1 after checking the above, perform the following:

- repeat manual tuning several times.
 - tune with a 50 Ω dummy load and re-tune the antenna.
 - turn power OFF and ON.
 - adjust the antenna cable length.
- (This is effective for higher frequencies in some cases.)

•Tuning a narrow bandwidth antenna

Some antennas, especially for low bands, have a narrow bandwidth. These antennas may not be tuned at the edge of their bandwidth, therefore, tune such an antenna as follows:

Suppose you have an antenna which has an SWR of 1.5:1 at 3.55 MHz and an SWR of 3:1 at 3.8 MHz.

- ① Push **[TUNER]** to turn the antenna tuner ON.
- ② Select CW mode.
- ③ Turn OFF the break-in function. (pgs. 4, 66)
- ④ Push **[TRANSMIT]** to set to the transmit condition.
- ⑤ Set 3.55 MHz and key down.
- ⑥ Set 3.80 MHz and key down.
- ⑦ Push **[TRANSMIT]** to return to the receive condition.

■ Optional external tuner operation

• AH-4/AH-3 HF AUTOMATIC ANTENNA TUNER

The AH-4 matches the IC-756PROIII to a long wire antenna more than 7 m/23 ft long (3.5 MHz and above).

The AH-3 matches the IC-756PROIII to a long wire antenna more than 3 m/10 ft long (3.5 MHz and above) or more than 12 m/40 ft long (1.8 MHz and above).

- See p. 18 for the transceiver and AH-4/AH-3 connection.
- See the AH-4/AH-3 instruction manual for AH-4/AH-3 installation and antenna connection details.

AH-4/AH-3 setting example:

For mobile operation

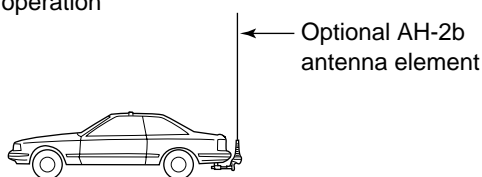

For outdoor operation

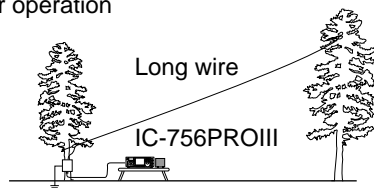

⚠ DANGER: HIGH VOLTAGE!
NEVER touch the antenna element while tuning or transmitting.

NEVER operate the AH-4/AH-3 without an antenna wire. The tuner and transceiver will be damaged.

NEVER operate the AH-4/AH-3 when it is not grounded.

Transmitting before tuning may damage the transceiver. Note that the AH-4/AH-3 cannot tune when using a $\frac{1}{2} \lambda$ long wire or multiple of the operating frequency.

- When connecting the AH-4/AH-3, the antenna connector assignments are **[ANT2]** for the internal tuner and **[ANT1]** for the AH-4/AH-3. The antenna indicator in the LCD displays "ANT1(EXT)" when the AH-4/AH-3 is connected and selected.
- The AH-3 can be used for HF bands only. It cannot be used for the 50 MHz band.

• AH-4/AH-3 operation

Tuning is required for each frequency. **Be sure** to re-tune the antenna before transmitting when you change the frequency—even slightly.

- ① Set the desired frequency in an HF or 50 MHz band for use with the AH-4. Set the desired frequency in an HF band for use with the AH-3.
 - The AH-4/AH-3 will not operate on frequencies outside of ham bands.
- ② Push **[TUNER]** for 1 sec.
 - The **[TUNER]** light blinks while tuning.

[TUNER]

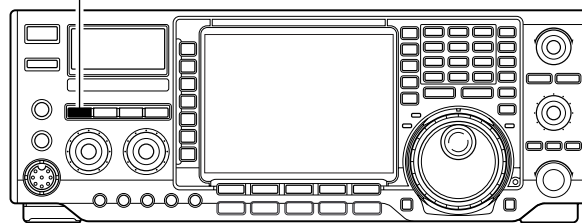

- ③ The **[TUNER]** light lights constantly when tuning is complete.
 - When the connected wire cannot be tuned, the **[TUNER]** light goes out and the AH-4/AH-3 is bypassed. At that point the antenna wire connection is to the transceiver directly, and not via the AH-4/AH-3 antenna tuner.
- ④ To bypass the AH-4/AH-3 manually, push **[TUNER]**.

• ANTENNA TUNER OF THE IC-PW1

When using an external antenna tuner such as the IC-PW1's tuner, tune with the external antenna tuner, while the internal tuner is turned OFF. After tuning is completed, turn the internal tuner ON. Otherwise, both tuners tune simultaneously and correct tuning may not be obtained.

See the instruction manual included with each antenna tuner for their respective operations.

11 CLOCK AND TIMERS

■ Time set mode

The transceiver has a built-in 24-hour clock with power-off and power-on timer functions. This is useful when logging QSO's and so on. The clock indication is always displayed except after pushing **[(F-INP)ENT]**.

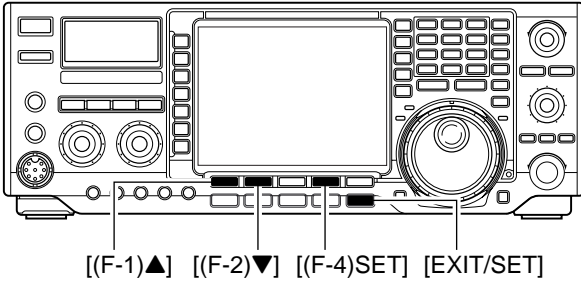

- ① Push **[EXIT/SET]** several times to close a multi-function screen, if necessary.
- ② Push **[EXIT/SET]** for 1 sec. to select the set mode menu screen.
- ③ Push **[(F-4)TIME]** to enter the time set mode.
- ④ Push **[(F-1)▲]** or **[(F-2)▼]** to select the desired item.
- ⑤ Rotate the tuning dial to set or select the desired value or condition.
- ⑥ Push **[EXIT/SET]** twice to exit the time set mode.

Time (Now)

This item sets the current time for the built-in 24-hour clock.

15:00

Push **[(F-4)SET]** to enter the time.

CLOCK2 Function

This item turns the clock 2 indication ON and OFF. The clock 2 is convenient to indicate the UTC or other country's local time, etc.
 • Push **[(F-3)DEF]** for 1 sec. to set the default value.

ON

The clock 2 is displayed below the local time. (default)

OFF

The clock 2 does not display.

CLOCK2 Offset

This item sets the desired off-set time period for the clock 2 indication within -24:00 to +24:00 in 5 min. steps.
 • Push **[(F-3)DEF]** for 1 sec. to set the default value.

0:00

(default)

+ 9:00

Rotate the tuning dial to set the time.

Timer Function

This item sets the timer functions ON and OFF. When the power-ON timer or the power-OFF timer is used, "ON" must be selected in this item.
 • Push **[(F-3)DEF]** for 1 sec. to set the default value.

ON

The timer functions can be operated. (default)

OFF

The timer functions cannot be operated.

Power-ON Timer set

This item sets the power-on time.

15:00

Push **[(F-4)SET]** to enter the time.

Power-OFF Period

This item sets the power-off period for automatic shut-down after the power-on timer has turned power ON.

60min

Push **[(F-4)SET]** to enter the time.

◇ Setting the current time

- ① Entering time set mode, push **[(F-1)▲]** to select the Time (Now) item.

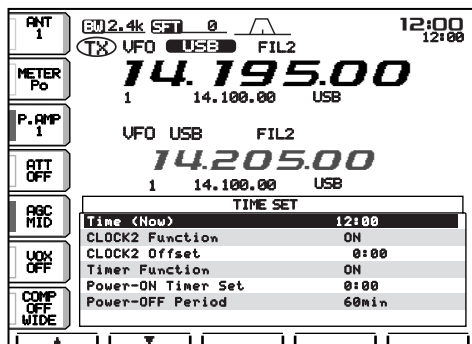

- ② Set the current time using the tuning dial.
 - “TIME-set Push [SET]” blinks.

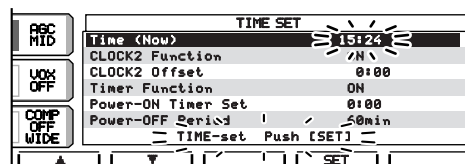

- ③ Push **[(F-4)SET]** to enter the set time.
 - Push **[EXIT/SET]** to cancel the setting.

Set time appears.

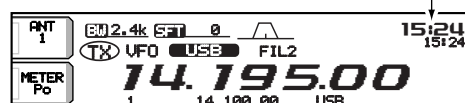

- ④ Push **[EXIT/SET]** twice to exit time set mode.

◇ Clock2 function activity

- ① Entering time set mode, push **[(F-1)▲]** or **[(F-2)▼]** to select the CLOCK2 Function item.
- ② Select the timer function activity using the tuning dial.
- ③ Push **[EXIT/SET]** twice to exit time set mode.

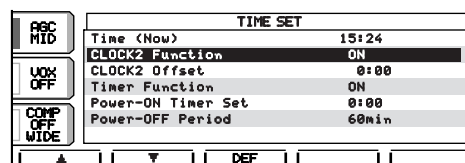

◇ Clock2 offset setting

- ① Entering time set mode, push **[(F-1)▲]** or **[(F-2)▼]** to select the CLOCK2 Offset item.
- ② Rotate the tuning dial to set the offset time within -24:00 to +24:00 in 5min. steps.
- ③ Push **[EXIT/SET]** twice to exit time set mode.

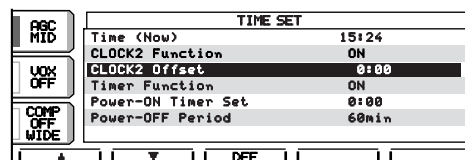

◇ Timer function activity

The timer functions can be switched ON and OFF

- ① Entering time set mode, push **[(F-1)▲]** or **[(F-2)▼]** to select the Timer Function item.

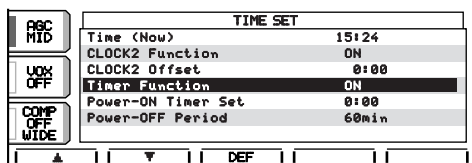

- ② Select the timer function activity using the tuning dial.

- ON : Activates the timer functions when **[POWER]** is pushed momentarily. (default)
- OFF : Deactivates the timer functions even when **[POWER]** is pushed momentarily.

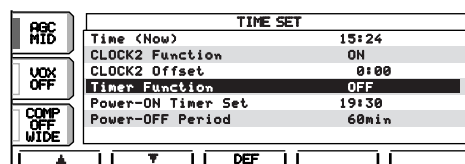

- ③ Push **[EXIT/SET]** twice to exit time set mode.

◇ Setting power-on time

The transceiver can be set to turn ON automatically at a specified time.

- ① Entering time set mode, push **[(F-1)▲]** or **[(F-2)▼]** to select the Power-ON Time Set item.

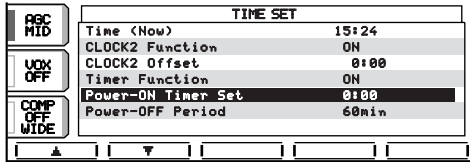

- ② Set the desired power-on time using the tuning dial.
 - “TIMER-set Push [SET]” blinks.

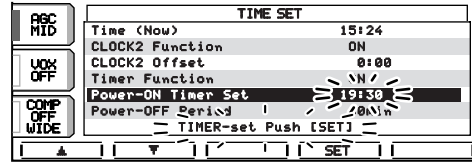

- ③ Push **[(F-4)SET]** to enter the set time.
 - Push **[EXIT/SET]** to cancel the setting.
- ④ Push **[EXIT/SET]** twice to exit time set mode.

◇ Setting power-off period

The transceiver can be set to turn OFF automatically after being activated via the power-on timer. The power-off period can be set to 5–120 min. in 5 min. steps.

- ① Entering time set mode, push **[(F-2)▼]** to select the Power-OFF Period item.

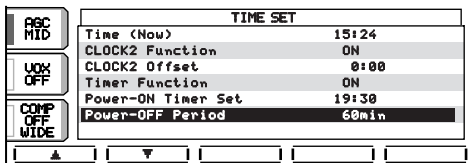

- ② Set the desired power-off time using the tuning dial.
 - “TIMER – set Push [SET]” blinks.

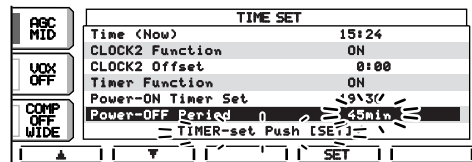

- ③ Push **[(F-4)SET]** to enter the set time.
 - Push **[EXIT/SET]** to cancel the setting.
- ④ Push **[EXIT/SET]** twice to exit timer set mode.

◇ Timer operation

- ① Preset the power-on time and power-off period as described previously.
- ② Push **[POWER]** momentarily to turn the timer function ON.
 - The **[POWER]** light lights when the timer function is ON.
- ③ Push **[POWER]** for 1 sec. to turn the power OFF.
 - The **[POWER]** light lights continuously.
- ④ When the set time arrives, the power is automatically turned ON.
- ⑤ The transceiver emits 10 beeps and turns OFF after the power-off period elapses.
 - The **[POWER]** light blinks while beeping.
 - Push **[POWER]** momentarily to cancel the power-off timer, if desired.

▨ The timer function in time set mode must be turned ON to enable the timer operation. See above for details.

[POWER]

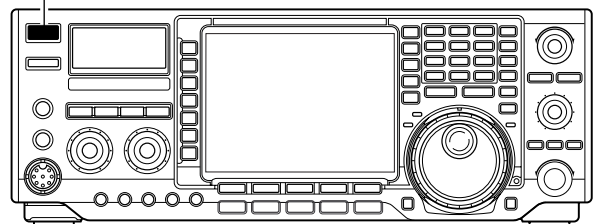

Set mode description

Set mode is used for programming infrequently changed values or conditions of functions. This transceiver has a level set mode, display set mode, timer set mode and miscellaneous (others) set mode.

Set mode operation

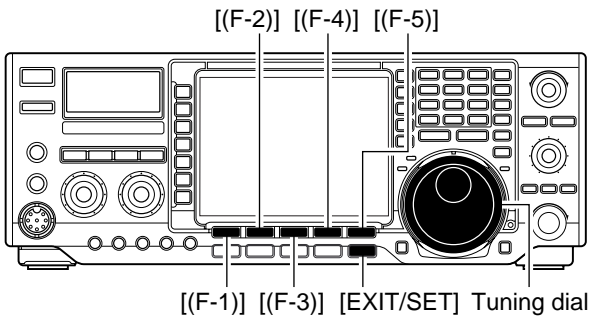

- ① Push **[EXIT/SET]** several times to close a multi-function screen, if necessary.
- ② Push **[EXIT/SET]** for 1 sec. to select the set mode menu screen.
- ③ Push **[(F-1)LEVEL]**, **[(F-2)DISP]**, **[(F-3)DSP]**, **[(F-4)TIME]** or **[(F-5)OTHERS]** to enter the desired set mode.
- ④ For level, display or miscellaneous (others) set mode, push **[(F-5)WIDE]** to toggle wide and normal screen.
- ⑤ Push **[(F-1)▲]** or **[(F-2)▼]** to select the desired item.
- ⑥ Set the desired condition using the tuning dial.
 - Push **[(F-3)DEF]** for 1 sec. to select a default condition or value.
- ⑦ Push **[EXIT/SET]** twice to exit the set mode.

Start up screen

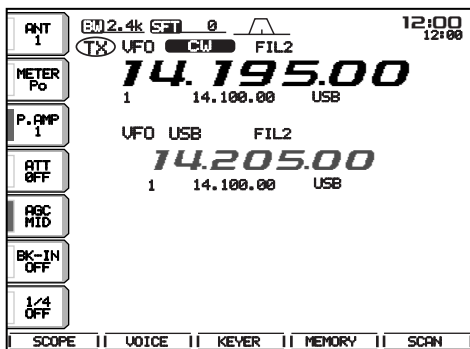

Push **[EXIT/SET]** for 1 sec.

Set mode menu screen

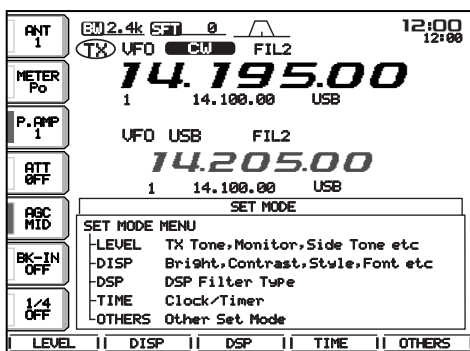

Level set mode (p. 95)

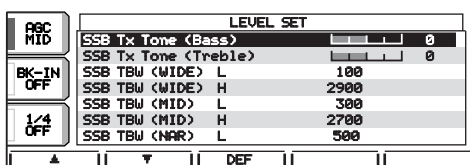

Display set mode (p. 97)

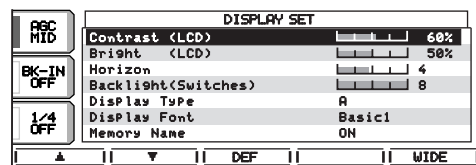

DSP set mode (p. 99)

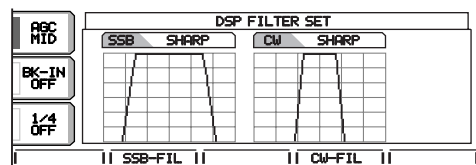

Time set mode (p. 91)

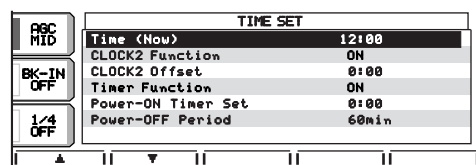

Miscellaneous (others) set mode (p. 99)

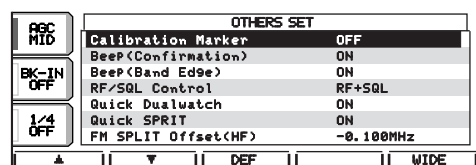

■ Level set mode

SSB Tx Tone (Bass)

This item adjusts the bass level of the transmit audio tone in SSB mode from -5 dB to +5 dB in 1 dB steps.

 0dB
0 dB (default)

SSB Tx Tone (Treble)

This item adjusts the treble level of the transmit audio tone in SSB mode from -5 dB to +5 dB in 1 dB steps.

 0dB
0 dB (default)

SSB TBW (WIDE) L

These items set the transmission passband width for wide setting by selecting the lower and higher frequencies.

Lower freq. : 100 (default), 300 and 500 Hz

100
100 Hz (default)

SSB TBW (WIDE) H

These items set the transmission passband width for wide setting by selecting the lower and higher frequencies.

Higher freq.: 2500, 2700 and 2900 Hz (default)

2900
2900 Hz (default)

SSB TBW (MID) L

These items set the transmission passband width for middle setting by selecting the lower and higher frequencies.

Lower freq. : 100, 300 (default) and 500 Hz

300
300 Hz (default)

SSB TBW (MID) H

These items set the transmission passband width for middle setting by selecting the lower and higher frequencies.

Higher freq.: 2500, 2700 (default) and 2900 Hz

2700
2700 Hz (default)

SSB TBW (NAR) L

These items set the transmission passband width for narrow setting by selecting the lower and higher frequencies.

Lower freq. : 100, 300 and 500 Hz (default)

500
500 Hz (default)

■ *Level set mode (continued)*

SSB TBW (NAR) H

These items set the transmission passband width for narrow setting by selecting the lower and higher frequencies.

Lower freq. : 2500 (default), 2700 and 2900 Hz

2500
2500 Hz (default)

Monitor Level

This item adjusts the transmit IF signal monitor level from 0% to 100% in 1% steps.

See p. 70 for details.

 **50%**
50% (default)

Side Tone Level

This item adjusts the CW side tone level from 0% to 100% in 1% steps.

See p. 70 for details.

 **50%**
50% (default)

Side Tone Level Limit

This item allows you to set a maximum volume level for CW side tones. CW side tones are linked to the [AF] control until a specified volume level is reached – further rotation of the [AF] control will not increase the volume of the CW side tones.

ON	OFF
CW side tone level is limited with [AF] (default)	CW side tone level is linked to [AF]

Beep Level

This item adjusts the volume level for confirmation beep tones from 0% to 100% in 1% steps. When beep tones are turned OFF, this setting has no effect.

 **50%**
50% (default)

Beep Level Limit

This item allows you to set a maximum volume level for confirmation beep tones. Confirmation beep tones are linked to the [AF] control until a specified volume level is reached – further rotation of the [AF] control will not increase the volume of the beep tones.

ON	OFF
Beep level is limited with [AF] (default)	Beep level is linked to [AF]

■ Display set mode

/// To adjust the LCD contrast or backlight, wait until the LCD becomes stable (10 min. or more after turning power ON). This is an inherent characteristic of LCDs and LCD backlights and does not indicate a transceiver malfunction.

Contrast (LCD)

This item adjusts the contrast of the LCD from 0% to 100% in 1% steps.

 60%
60% (default)

Backlight (LCD)

This item adjusts the brightness of the LCD from 0% to 100% in 1% steps.

 50%
50% (default)

Horizon

This item adjusts the horizontal position of the LCD from 1 to 8.

 4
Horizontal position is 4. (default)

Backlight(Switches)

This item adjusts the brightness of the switches from 1 to 8.

 8
Backlight level is 8. (Maximum; default)

Display Type

This item sets the LCD screen type. There are 8 selectable types: A, B, C, D, E, F, G and H.

A
A-type LCD screen (default)

Display Font

This item sets the font of the frequency readouts. There are 7 selectable fonts: Basic1, Basic2, Pop, 7seg (7 segment numeral), Italic 1, Italic 2 and Classic.

Italic2
Italic 2 font (default)

Memory Name

This item sets the memory name indication ON and OFF.

See p. 81 for details.

ON	OFF
Memory name is displayed. (default)	Memory name is not displayed.

■ Display set mode (continued)

Screen Saver Function

This item sets the screen saver setting from 60 min, 30 min, 15 min and OFF.

60 min

Screen saver function activates after 60 minute of inactivity. (default)

30 min

Screen saver function activates after 30 minute of inactivity.

15 min

Screen saver function activates after 15 minute of inactivity.

OFF

Screen saver function is OFF.

My Call

Your call sign, etc. can be displayed in the opening screen when turning power ON. Up to 10 characters can be programmed.

Capital letters, numerals, some symbols (– / ·) and spaces can be used.

- ① Push **[EXIT/SET]** several times to close a multi-function screen, if necessary.
- ② Push **[EXIT/SET]** for 1 sec. then **[(F-2)DISP]** momentarily to select the display set mode screen.
- ③ Push **[(F-2)▼]** several times to select the 'My Call' item.

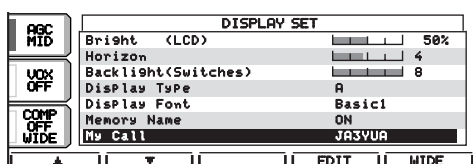

- ④ Push **[(F-4)EDIT]** to edit.
 - A cursor appears and blinks.

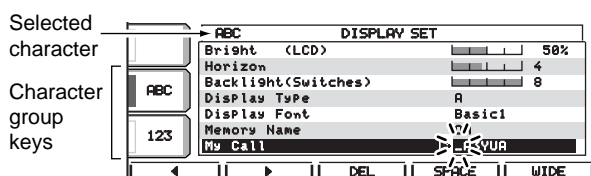

- ⑤ Input the desired character by rotating the tuning dial or by pushing the band key for number input.
 - Push **[ABC]** to select capital letters.
 - Push **[123]** or **[etc]** to toggle numerals and symbols.
 - Push **[(F-1)◀]** or **[(F-2)▶]** for cursor movement.
 - Push **[(F-3)DEL]** to delete the selected character.
 - Push **[(F-4)SPACE]** to input a space.
- ⑥ Push **[EXIT/SET]** to input the set name.
 - The cursor disappears.
- ⑦ Push **[EXIT/SET]** to exit the set mode screen.

•Opening screen example



DSP filter set mode

To suit your operating style, the type of DSP filter shape for SSB and CW can be selected.

- ① Push the **[EXIT/SET]** several times to close a multi-function screen, if necessary.
- ② Push the **[EXIT/SET]** switch for 1 sec. to enter set mode.
- ③ Push the **[(F-3)DSP]** switch to enter the DSP filter set mode.
- ④ Push one of **[(F-2)SSB-FIL]** or **[(F-4)CW-FIL]** to select the desired DSP filter shape from sharp and soft for SSB or CW mode, respectively.
- ⑤ Push **[EXIT/SET]** twice to exit the DSP filter set mode.

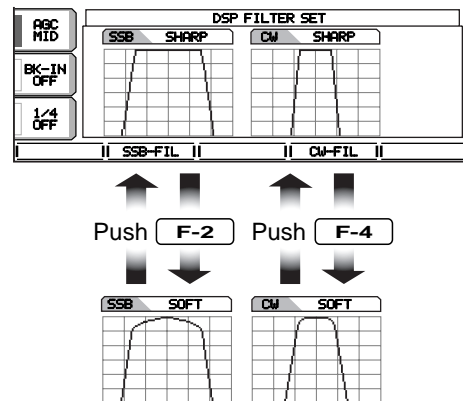

Miscellaneous (others) set mode

Calibration Marker

This item is used for a simple frequency check of the transceiver.

See p. 109 for calibration procedure.

Turn the calibration marker OFF after checking the frequency of the transceiver.

ON

Calibration marker ON

OFF

Calibration marker OFF (default)

Beep (Confirmation)

A beep sounds each time a switch is pushed to confirm it. This function can be turned OFF for silent operation.

The volume level can be set in level set mode. (p. 96)

ON

Confirmation beep ON (default)

OFF

Confirmation beep OFF

Beep (Band Edge)

A beep sounds when an operating frequency enters or exits an amateur band. This functions independent of the confirmation beep setting (above).

The volume level can be set in level set mode. (p. 96)

ON

Band edge beep ON (default)

OFF

Band edge beep OFF

RF/SQL Control

The **[RF/SQL]** control can be set as the RF/squelch control (default), the squelch control only (RF gain is fixed at maximum) or 'Auto' (RF gain control in SSB, CW and RTTY; squelch control in AM and FM).

See pgs. 2, 30 for details.

RF+SQL

[RF/SQL] control as RF/squelch control (default)

SQL

[RF/SQL] control as squelch control

AUTO

[RF/SQL] control as RF gain control in SSB, CW and RTTY; squelch control in AM and FM

■ Miscellaneous (others) set mode (continued)

Quick Dualwatch	When this item is set to ON, pushing [DUALWATCH] for 1 sec. sets the sub readout frequency to the main readout frequency and activates dualwatch operation.	ON Quick dualwatch ON (default)	OFF Quick dualwatch OFF
See p. 63 for details.			
Quick SPLIT	When this item is set to ON, pushing [SPLIT] for 1 sec. sets the sub readout frequency to the main readout frequency and activates split operation.	ON Quick split ON (default)	OFF Quick split OFF
See p. 72 for details.			
FM SPLIT Offset(HF)	This item sets the offset (difference between transmit and receive frequencies) for the quick split function. However, this setting is used for HF bands in FM mode only and is used to input the repeater offset for an HF band.	-0.100MHz Minus 0.1 MHz offset (default)	-4.000MHz Minus 4.0 MHz offset
The offset frequency can be set from -4 MHz to +4 MHz in 1 kHz steps.			
FM SPLIT Offset(50M)	This item sets the offset (difference between transmit and receive frequencies) for the quick split function. However, this setting is used for 50 MHz band FM mode only, and is used to input the repeater offset for the 50 MHz band.	-0.500MHz Minus 0.5 MHz offset (default)	+4.000MHz Plus 4.0 MHz offset
The offset frequency can be set from -4 MHz to +4 MHz in 1 kHz steps.			
SPLIT LOCK	When this item is ON, the tuning dial can be used to adjust the transmit frequency while pushing [XFC] even while the lock function is activated.	ON Split lock function ON	OFF Split lock function OFF (default)
See p. 71 for split frequency operation details.			

■ Miscellaneous (others) set mode (continued)

Tuner (Auto Start)

The internal antenna tuner has an automatic start capability which starts tuning if the SWR is higher than 1.5–3:1.

When “OFF” is selected, the tuner remains OFF even when the SWR is poor (1.5–3:1). When “ON” is selected, automatic tune starts even when the tuner is turned OFF.

ON	OFF
Automatic tuner start ON	Automatic tuner start OFF (default)

Tuner (PTT Start)

Tuning of the internal antenna tuner can be started automatically at the moment the PTT is pushed after the operating frequency is changed (more than 1% from last-tuned frequency).

ON	OFF
Automatic PTT start ON	Automatic PTT start OFF (default)

[ANT] Switch

You can set the antenna connector selection to automatic, manual or non-selection (when using 1 antenna only).

When “Auto” is selected, the antenna switch is activated and the band memory memorizes the selected antenna. See p. 88 for details.

When “Manual” is selected, the antenna switch is activated and selects an antenna manually.

When “OFF” is selected, the antenna switch is not activated and does not function. The **[ANT1]** connector is always selected in this case.

Auto	Antenna switch is activated and the selection is automatically memorized. (default)
Manual	Antenna switch is activated.
OFF	Antenna switch is deactivated and [ANT1] is always selected.

RTTY Mark Frequency

This item selects the RTTY mark frequency. RTTY mark frequency is switched between 1275, 1615 and 2125 Hz.

2125	1275
2125 Hz RTTY mark frequency (default)	1275 Hz RTTY mark frequency

RTTY Shift Width

This item adjusts the RTTY shift width. There are 3 selectable values: 170, 200 and 425 Hz.

170	425
170 Hz RTTY shift frequency (default)	425 Hz RTTY shift frequency

RTTY Keying Polarity

This item selects the RTTY keying polarity. Normal or reverse keying polarity can be selected.

When reverse polarity is selected, Mark and Space are reversed.

- Normal : Key open/close = Mark/Space
- Reverse : Key open/close = Space/Mark

Normal	Reverse
Normal polarity (default)	Reverse polarity

■ Miscellaneous (others) set mode (continued)

SPEECH Language	English	Japanese
When the optional UT-102 VOICE SYNTHESIZER UNIT is installed, you can select between English and Japanese as the language.	English announcement (default)	Japanese announcement
See p. 105 for unit installation.		

SPEECH Speed	HIGH	LOW
When the optional UT-102 VOICE SYNTHESIZER UNIT is installed, you can select between faster or slower synthesizer output.	Faster announcement (default)	Slower announcement
See p. 105 for unit installation.		

SPEECH S-Level	ON	OFF
When the optional UT-102 VOICE SYNTHESIZER UNIT is installed, you can have frequency, mode and signal level announcement. Signal level announcement can be deactivated if desired.	Signal level announcement (default)	No signal level announcement
When "OFF" is selected, the signal level is not announced.		
See p. 105 for unit installation.		

MemoPad Numbers	5	10
This item sets the number of memo pad channels available. 5 or 10 memo pads can be set.	5 memo pads (default)	10 memo pads

■ Miscellaneous (others) set mode (continued)

MAIN DIAL Auto TS

This item sets the auto tuning step function. When rotating the tuning dial rapidly, the tuning step automatically changes several times as selected.

There are 2 type of auto tuning steps: HIGH (Fastest) and LOW (Faster).

HIGH	Auto tuning step is turned ON. Fastest tuning step during rapid rotation (default)
LOW	Auto tuning step is turned ON. Faster tuning step during rapid rotation
OFF	Auto tuning step is turned OFF.

MIC UP/Down Speed

This item sets the rate at which frequencies are scanned when the microphone [UP]/[DN] switches are pushed and held. High or low can be selected.

HIGH	LOW
High speed (default, 50 tuning steps/sec.)	Low speed (25 tuning steps/sec.)

Quick RIT/ΔTX Clear

This item selects the RIT/ΔTX frequency clearing instruction with the [CLEAR] switch.

ON	OFF
Clears the RIT/ΔTX frequency when [CLEAR] is pushed momentarily.	Clears the RIT/ΔTX frequency when [CLEAR] is pushed for 1 sec. (default)

SSB/CW Synchronous Tuning

This item selects the displayed frequency shift function from ON and OFF.

When this function is activated, the receiving signal can be kept to receive even when the operating mode is changed between SSB and CW.

/// The frequency shifting value may differ according to the CW pitch setting.

ON	OFF
The displayed frequency shifts when the operating mode is changed between SSB and CW.	The displayed frequency does not shift. (default)

CW Normal Side

Selects the carrier point of CW mode from LSB and USB.

LSB	USB
The carrier point is set to LSB side. (default)	The carrier point is set to USB side.

■ Miscellaneous (others) set mode (continued)

External Keypad

This item sets the external keypad capability and function.

For your information

The following diagram shows the equivalent circuit of an external keypad and connects to the pin 3 and pin 7 of the [MIC] connector (p. 18).

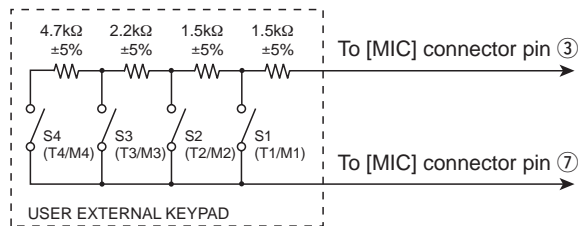

Auto

Pushing one of external keypad switches, transmits the desired voice memory during a phone mode (SSB, AM or FM), or memory keyer contents during CW mode operation.

VOICE PLAY(TX)

Pushing one of external keypad switches, transmits the desired voice memory contents during a phone mode operation.

KEYER SEND

Pushing one of external keypad switches, transmits the desired keyer memory contents during CW mode operation.

OFF

External keypad does not function. (default)

CI-V Baud Rate

This item sets the data transfer rate. 300, 1200, 4800, 9600, 19200 bps and “Auto” are available.

When “Auto” is selected, the baud rate is automatically set according to the connected controller or remote controller.

Auto

19200

Auto baud rate (default)

19200 bps

CI-V Address

To distinguish equipment, each CI-V transceiver has its own Icom standard address in hexadecimal code. The IC-756PROIII's address is 6Eh.

When 2 or more IC-756PROIII's are connected to an optional CT-17 CI-V LEVEL CONVERTER, rotate the tuning dial to select a different address for each IC-756PROIII in the range 01h to 7Fh.

6Eh

7Fh

Address of 6Eh (default)

Address of 7Fh

CI-V Transceive

Transceive operation is possible with the IC-756PROIII connected to other Icom HF transceivers or receivers.

When “ON” is selected, changing the frequency, operating mode, etc. on the IC-756PROIII automatically changes those of connected transceivers (or receivers) and vice versa.

ON

OFF

Transceive ON (default)

Transceive OFF

CI-V with IC-731

When connecting the IC-756PROIII to the IC-735 for transceive operation, you must change the operating frequency data length to 4 bytes.

• This item must be set to “ON” only when operating the transceiver with the IC-735.

ON

OFF

4 bytes of frequency data

5 bytes of frequency data (default)

13 OPTION INSTALLATION

■ Opening the transceiver's cases

Follow the case and cover opening procedures shown here when you want to install an optional unit or adjust the internal units, etc.

CAUTION: DISCONNECT the DC power cable from the transceiver before performing any work on the transceiver. Otherwise, there is danger of electric shock and/or equipment damage.

- ① Remove 2 screws from the left side of the transceiver to remove the carrying handle as shown below.

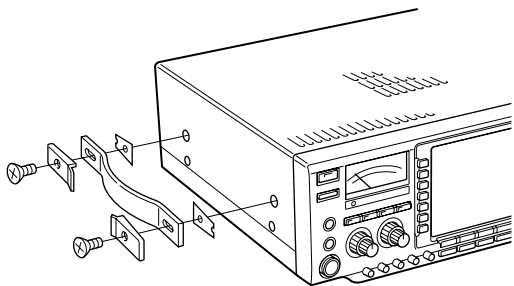

- ② Remove 7 screws from the top of the transceiver and 4 screws from the sides, then lift up the top cover.
- ③ Turn the transceiver upside down.
- ④ Remove 6 screws from the bottom of the transceiver, then lift up the bottom cover.

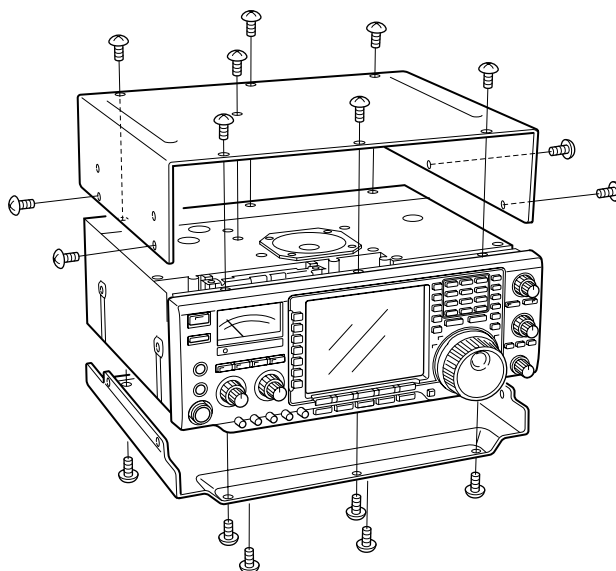

■ UT-102 VOICE SYNTHESIZER UNIT

The UT-102 announces the accessed readout's frequency, mode, etc. (S-meter level can also be announced—p. 102) in a clear, electronically-generated voice, in English (or Japanese).

➡ Push **[LOCK/SPEECH]** for 1 sec. to announce the frequency, etc.

- ① Remove the top and bottom covers as shown above.
- ② Remove the protective paper attached to the bottom of the UT-102 to expose the adhesive strip.
- ③ Plug UT-102 into J3502 on the MAIN unit as shown in the diagram at right.
- ④ Adjust the trimmer SPCH to set the speech level if desired. Refer to inside views on p. 106.
- ⑤ Return the top and bottom covers to their original positions.

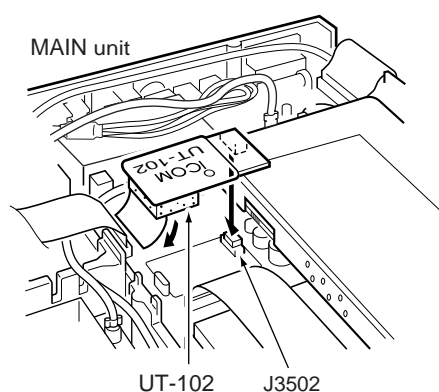

•Top view

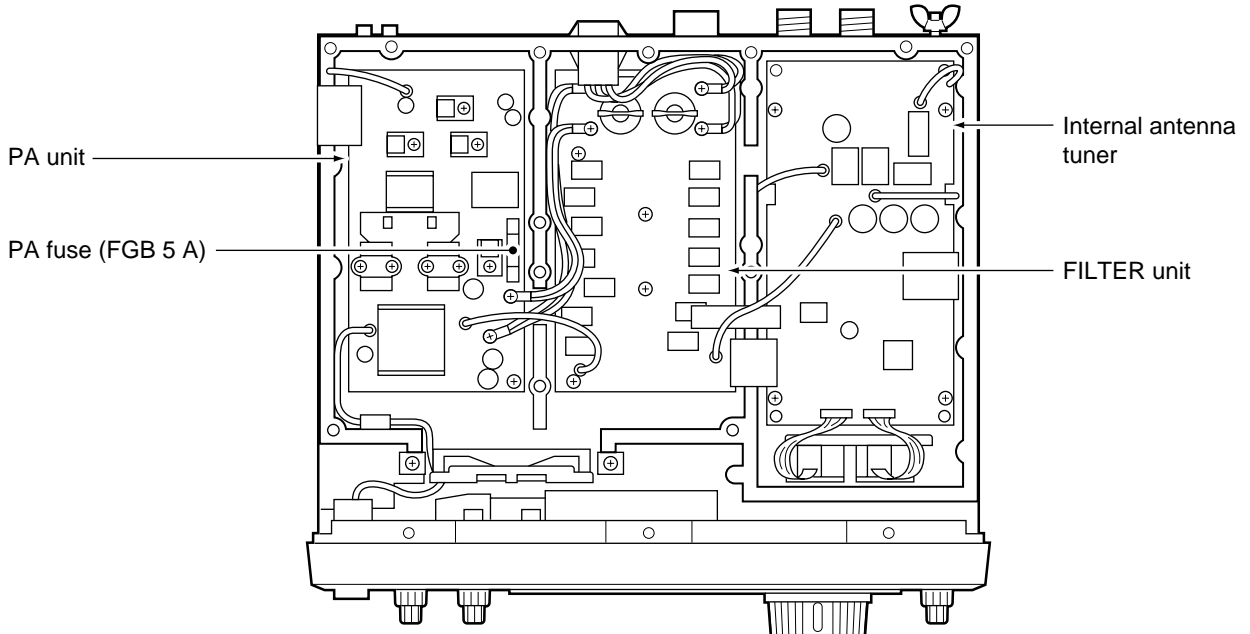

•Bottom view

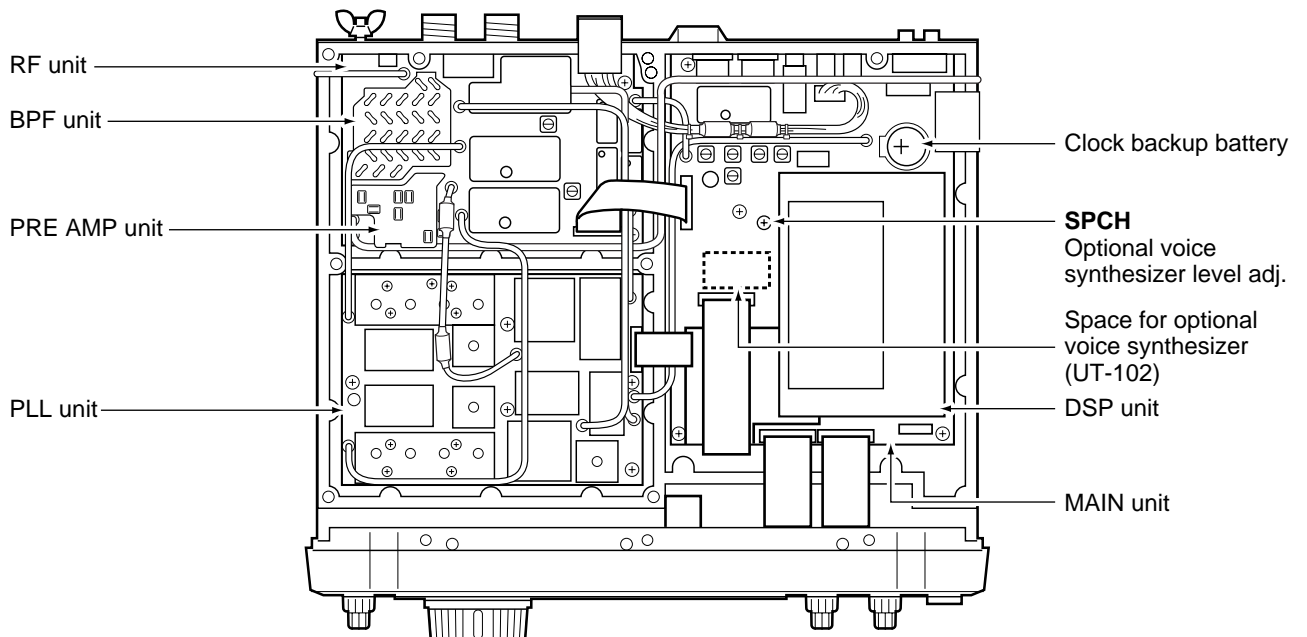

■ Troubleshooting

The following chart is designed to help you correct problems which are not equipment malfunctions.

If you are unable to locate the cause of a problem or solve it through the use of this chart, contact your nearest Icom Dealer or Service Center.

	PROBLEM	POSSIBLE CAUSE	SOLUTION	REF.
POWER	Power does not come on when the [POWER] switch is pushed.	<ul style="list-style-type: none"> Power cable is improperly connected. Fuse is blown. 	<ul style="list-style-type: none"> Re-connect the DC power cable correctly. Check for the cause, then replace the fuse with the spare one. (Fuses are installed in the DC power cable and the internal PA unit.) 	p. 16 p. 108
	No sounds come out from the speaker.	<ul style="list-style-type: none"> Volume level is too low. The squelch is closed. The transceiver is in transmitting condition. 	<ul style="list-style-type: none"> Rotate [AF] clockwise to obtain a suitable listening level. Turn [RF/SQL] to 10 o'clock position to open the squelch. Push [TRANSMIT] to receive or check the SEND line of an external unit, if desired. 	p. 1 p. 2 p. 1
RECEIVE	Sensitivity is too low, and only strong signals are audible.	<ul style="list-style-type: none"> The antenna is not connected properly. The antenna for another band is selected. The antenna is not properly tuned. The attenuator is activated. 	<ul style="list-style-type: none"> Re-connect to the antenna connector. Select an antenna suitable for the operating frequency. Push [TUNER] for 1 sec. to manually tune the antenna. Push [ATT] several times to select "ATT OFF." 	— pgs. 3, 88 p. 89 p. 3
	Received audio is unclear or distorted.	<ul style="list-style-type: none"> Wrong operating mode is selected. PBT function is activated. Noise blanker is turned ON when receiving a strong signal. Preamp is activated. The noise reduction is activated and the [NR] control is too far clockwise. 	<ul style="list-style-type: none"> Select a suitable operating mode. Push [PBT CLR] for 1 sec. to reset the function. Push [NB] to turn the noise blanker OFF. Push [P.AMP] once or twice to turn the function OFF. Set the [NR] control for maximum readability. 	p. 29 p. 60 p. 64 p. 3 p. 65
	The [ANT] switch does not function.	<ul style="list-style-type: none"> The antenna switch has not been activated. 	<ul style="list-style-type: none"> Set the antenna switch in set mode to "Auto" or "Manual." 	p. 88
	Transmitting is impossible.	<ul style="list-style-type: none"> The operating frequency is not set to a ham band. 	<ul style="list-style-type: none"> Set the frequency to a ham band. 	p. 25
TRANSMIT	Output power is too low.	<ul style="list-style-type: none"> [RF POWER] is set too far counterclockwise [MIC GAIN] is set too far counterclockwise The antenna for another band is selected. The antenna is not properly tuned. 	<ul style="list-style-type: none"> Rotate [RF POWER] clockwise. Set [MIC GAIN] to a suitable position. Select an antenna suitable for the operating frequency. Push [TUNER] for 1 sec. to manually tune the antenna. 	p. 2 p. 1 p. 3 p. 89
	You can receive signals, but no contact possible with another station.	<ul style="list-style-type: none"> RIT or ΔTX function is activated. Split frequency function and/or dualwatch are activated. 	<ul style="list-style-type: none"> Push [RIT] or [ΔTX] to turn the function OFF. Push [SPLIT] and/or [DUALWATCH] to turn the function OFF. 	p. 6 pgs. 8, 63, 71
	Transmit signal is unclear or distorted.	<ul style="list-style-type: none"> [MIC GAIN] is set too far clockwise. The speech compressor function is activated. 	<ul style="list-style-type: none"> Set [MIC GAIN] to a suitable position. Push [COMP] to turn the function OFF. 	p. 1 p. 68
	Repeater cannot be accessed.	<ul style="list-style-type: none"> Split frequency function is not activated. Programmed subaudible tone frequency is set at wrong frequency. 	<ul style="list-style-type: none"> Push [SPLIT] to turn the function ON Reset the frequency using set mode. 	p. 8 p. 52
	Programmed scan does not stop.	<ul style="list-style-type: none"> Squelch is open. [RF/SQL] is assigned to RF gain control and squelch is open. 	<ul style="list-style-type: none"> Set [RF/SQL] to the threshold point. Reset [RF/SQL] control assignment and set it to the threshold point. 	p. 2 pgs. 2, 30, 99
SCAN	Programmed scan does not start.	<ul style="list-style-type: none"> The same frequencies have been programmed in scan edge memory channels P1 and P2. 	<ul style="list-style-type: none"> Program different frequencies in scan edge memory channel P1 and P2. 	p. 79
	Memory scan does not start.	<ul style="list-style-type: none"> 2 or more memory channels have not been programmed. 	<ul style="list-style-type: none"> Program more than 2 memory channels. 	p. 79
	Select memory scan does not start.	<ul style="list-style-type: none"> 2 or more memory channels have not been designated as select channels. 	<ul style="list-style-type: none"> Designate more than 2 memory channels as select channels for the scan. 	pgs. 78, 86

	PROBLEM	POSSIBLE CAUSE	SOLUTION	REF.
DISPLAY	The displayed frequency does not change properly.	<ul style="list-style-type: none"> • The dial lock function is activated. • A set mode screen is selected. • The internal CPU has malfunctioned. 	<ul style="list-style-type: none"> • Push [LOCK/SPEECH] to turn the function OFF. • Push [EXIT/SET] several times to exit the set mode screen. • Reset the CPU. 	p. 65 pgs. 10, 94 p. 21

■ Fuse replacement

If a fuse blows or the transceiver stops functioning, try to find the source of the problem, and replace the damaged fuse with a new, rated fuse.

CAUTION: DISCONNECT the DC power cable from the transceiver when changing a fuse.

The IC-756PROIII has 2 types of fuses installed for transceiver protection.

- DC power cable fuses FGB 30 A
- Circuitry fuse FGB 5 A

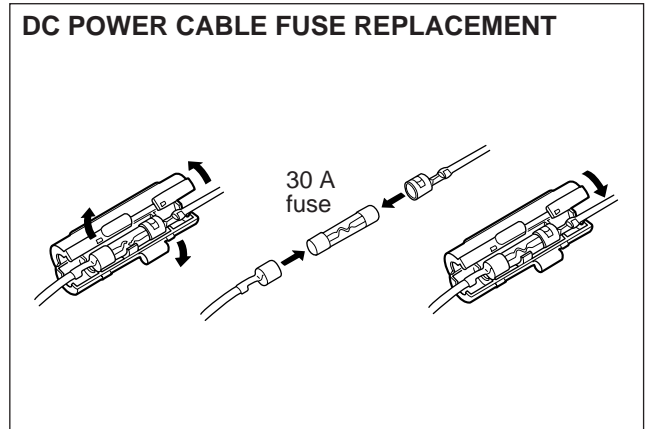

CIRCUITRY FUSE REPLACEMENT

The 13.8 V DC from the DC power cable is converted to 5 V or 8 V and applied to all units in the IC-756PROIII, except for the power amplifier, through the circuitry fuse. This fuse is installed in the PA unit.

- ① Remove the top cover as shown on p. 105.
- ② Remove 11 screws from the PA shielding plate, then remove the plate.

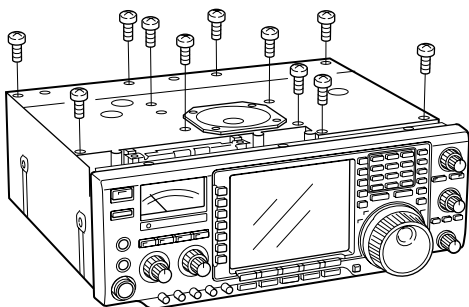

- ③ Replace the circuitry fuse as shown in the diagram below.
- ④ Replace the PA shielding plate and top cover.

Circuitry fuse (FGB 5 A)

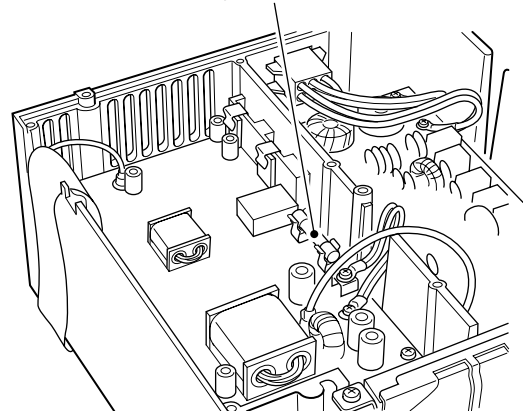

■ Clock backup battery replacement

The transceiver has a lithium backup battery (CR2032) inside for clock and timer functions. The usual life of the backup battery is approximately 2 years.

When the backup battery is exhausted, the transceiver transmits and receives normally but cannot retain the current time.

See p. 106 for battery location.

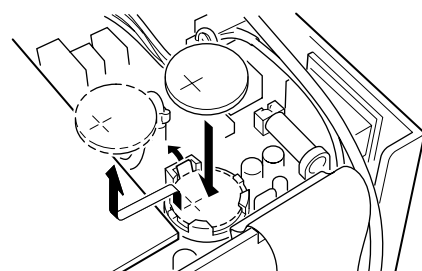

■ Tuning dial brake adjustment

The tension of the tuning dial may be adjusted to suit your preference.

The brake adjustment screw is located on the right side of the tuning dial. See the figure at right.

Turn the brake adjustment screw clockwise or counterclockwise to obtain a comfortable tension level while turning the dial continuously and evenly in one direction.

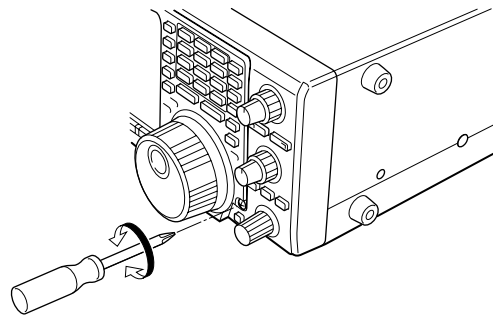

■ Frequency calibration (approximate)

A very accurate frequency counter is required to calibrate the frequency of the transceiver. However, a rough check may be performed by receiving radio station WWV, or other standard frequency signals.

CAUTION: Your transceiver has been thoroughly adjusted and checked at the factory before being shipped. You should not calibrate frequencies, except for special reasons.

- ① Push **[SSB]** to select USB mode.
- ② Push **[PBT CLR]** for 1 sec. to clear the PBT settings and make sure that the RIT/ Δ TX function is not activated.
- ③ Set the frequency to the standard frequency station minus 1 kHz.
 - When receiving WWV (10.000.00 MHz) as a standard frequency, set the operating frequency for 9.999.00 MHz.
 - Other standard frequencies can also be used.

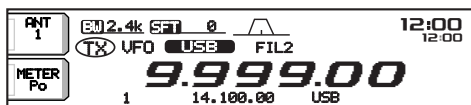

- ④ Push **[EXIT/SET]** several times to close a multi-function screen, if necessary.
- ⑤ Push **[EXIT/SET]** for 1 sec. to select the set mode screen.
- ⑥ Push **[(F-5)OTHERS]** to enter miscellaneous (others) set mode.

- ⑦ Push **[(F-1)▲]** several times to select the “Calibration marker” item.
- ⑧ Rotate the tuning dial clockwise to turn the calibration marker ON.
 - Side tone may be heard.

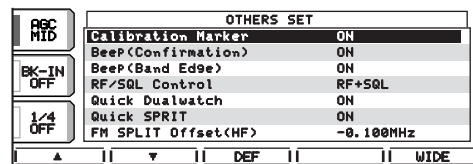

- ⑨ Adjust the calibration pot on the right side panel of the transceiver for a zero beat with the received standard signal as shown below.
 - Zero beat means that two signals are exactly the same frequency, resulting in a single tone being emitted.

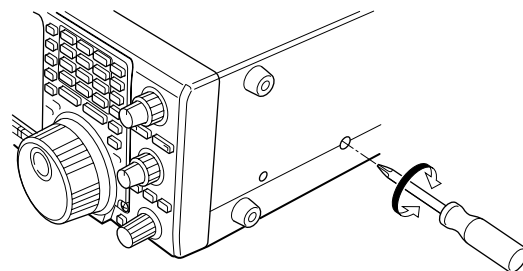

- ⑩ Rotate the tuning dial counterclockwise to turn the calibration marker OFF.
- ⑪ Push **[EXIT/SET]** twice to exit set mode.

Remote jack (CI-V) information

•CI-V connection example

The transceiver can be connected through an optional CT-17 CI-V LEVEL CONVERTER to a personal computer equipped with an RS-232C port. The Icom Communications Interface-V (CI-V) controls the following functions of the transceiver.

Up to 4 Icom CI-V transceivers or transceivers can be connected to a personal computer equipped with an RS-232C port. See p. 104 for setting the CI-V condition using set mode.

•Data format

The CI-V system can be operated using the following data formats. Data formats differ according to command numbers. A data area or sub command is added for some commands.

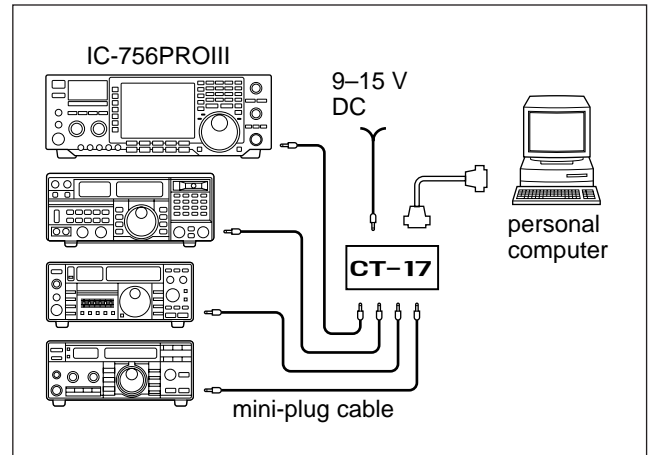

Controller to IC-756PROIII

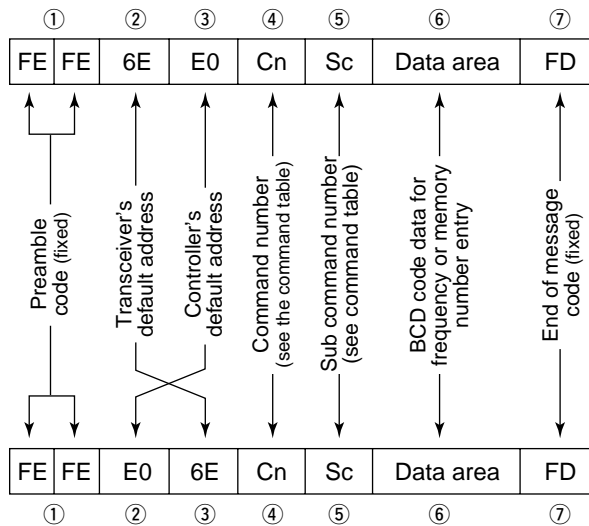

IC-756PROIII to controller

OK message to controller

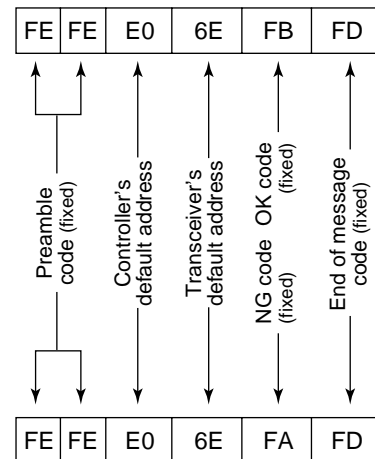

NG message to controller

•Command table

Command	Sub command	Description
00	—	Send frequency data
01	Same as command 06	Send mode data
02	—	Read band edge frequencies
03	—	Read operating frequency
04	—	Read operating mode
05	—	Set frequency data
06	00	Select LSB
	01	Select USB
	02	Select AM
	03	Select CW
	04	Select RTTY
	05	Select FM
	07	Select CW-R
	08	Select RTTY-R
07	—	Select VFO mode
	B0	Exchange main and sub readouts
	B1	Equalize main and sub readouts
	C0	Turn the dualwatch OFF
	C1	Turn the dualwatch ON
	D0	Select main readout
D1	Select sub readout	
08	—	Select memory mode
	0001–0101*1	Select memory channel *1P1=0100, P2=0101
09	—	Memory write
0A	—	Memory to VFO
0B	—	Memory clear
0E	00	Scan stop
	01	Programmed/memory scan start
	02	Programmed scan start
	03	Δ F scan start
	12	Fine programmed scan start
	13	Fine Δ F scan start
	22	Memory scan start
	23	Select memory scan start
	A1–A7	Set Δ F scan span (A1= \pm 5 kHz, A2= \pm 10 kHz, A3= \pm 20 kHz, A4= \pm 50 kHz, A5= \pm 100 kHz, A6= \pm 500 kHz, A7= \pm 1 MHz)
B0	Set as non-select channel	
B1	Set as select channel	
D0	Set scan resume OFF	
D3	Set scan resume ON	
0F	00	Turn the split function OFF
	01	Turn the split function ON
10	00	Select 10 Hz (1 Hz) tuning step
	01	Select 100 Hz tuning step
	02	Select 1 kHz tuning step
	03	Select 5 kHz tuning step
	04	Select 9 kHz tuning step
	05	Select 10 kHz tuning step
	06	Select 12.5 kHz tuning step
	07	Select 20 kHz tuning step
08	Select 25 kHz tuning step	
11	00	Attenuator OFF
	06	Attenuator ON (6 dB)
	12	Attenuator ON (12 dB)
	18	Attenuator ON (18 dB)

Command	Sub command	Description
12	00	Select/read antenna selection
	01	(00=ANT1, 01=ANT2 : Add 0 or 1 to turn [RX ANT] OFF or ON, respectively.)
13	00	Announce with voice synthesizer
	01	(00=all data; 01=frequency and S-meter level; 02=receive mode)
	02	
14	01 + Level data	[AF] level setting (0=max. CCW to 255=max. CW)
	02 + Level data	[RF] level setting (0=max. CCW to 255=11 o'clock)
	03 + Level data	[SQL] level setting (0=11 o'clock to 255=max. CW)
	06 + Level data	[NR] level setting (0=min. to 255=max.)
	07 + Level data	Inside [TWIN PBT] setting or IF shift setting (0=max. CCW, 128=center, 255=max. CW)
	08 + Level data	Outside [TWIN PBT] setting (0=max. CCW, 128=center, 255=max. CW)
	09 + Level data	[CW PITCH] setting (0=low pitch to 255=high pitch)
	0A + Level data	[RF POWER] setting (0=mini. to 255=max.)
	0B + Level data	[MIC GAIN] setting (0=mini. to 255=max.)
	0C + Level data	[KEY SPEED] setting (0=slow to 255=fast)
	0D + Level data	[NOTCH] setting (0=low freq. to 255=high freq.)
	0E + Level data	[COMP] setting (0=mini. to 255=max.)
	0F + Level data	[BK-IN DELAY] setting (0=short delay to 255=long delay)
	10 + Level data	[BAL] level setting (0=max. CCW, 128=center, 255=max. CW)
	12 + Level data	[NB] level setting (0=mini. to 255=max.)
	15 + Level data	Monitor gain setting (0=0% to 255=100%)
	16 + Level data	VOX gain setting (0=0% to 255=100%)
	17 + Level data	Anti-VOX gain setting (0=0% to 255=100%)
	18 + Level data	LCD contrast setting (0=0% to 255=100%)
19 + Level data	LCD bright setting (0=0% to 255=100%)	
15	01	Read squelch condition
	02	Read S-meter level
	11	Read Po meter level
	12	Read SWR meter level
	13	Read ALC meter level
	14	Read COMP meter level
16	02	Preamp (0=OFF; 1=preamp 1; 2=preamp 2)
	12	AGC selection (1=Fast; 2=Mid; 3=Slow)

•Command table (continued)

Command	Sub command	Description	Command	Sub command	Description
16	22	Noise blanker (0=OFF; 1=ON)	1A	0517	Send/read power-ON timer set (0000 to 2359)
	40	Noise reduction (0=OFF; 1=ON)		0518	Send/read power-OFF period (5=5 min. to 120=120 min. in 5 min. step)
	41	Auto notch (0=OFF; 1=ON)		0519	Send/read calibration marker (0=OFF, 1=ON)
	42	Repeater tone (0=OFF; 1=ON)		0520	Send/read confirmation beep (0=OFF, 1=ON)
	43	Tone squelch (0=OFF; 1=ON)		0521	Send/read band edge beep (0=OFF, 1=ON)
	44	Speech compressor (0=OFF; 1=ON)		0522	Send/read RF/SQL control set (0=Auto, 1=SQL, 2=RF+SQL)
	45	Monitor (0=OFF; 1=ON)		0523	Send/read quick dualwatch set (0=OFF, 1=ON)
	46	VOX function (0=OFF; 1=ON)		0524	Send/read quick split set (0=OFF, 1=ON)
	47	Break-in (0=OFF; 1=semi break-in; 2=full break-in)		0525	Send/read FM split offset (HF) -4.000 to +4.000 MHz (see p. 114 for details)
	48	Manual notch (0=OFF; 1=ON)		0526	Send/read FM split offset (50 MHz) -4.000 to +4.000 MHz (see p. 114 for details)
	49	RTTY filter (0=OFF; 1=ON)		0527	Send/read split lock set (0=OFF, 1=ON)
4F	Twin peak filter (0=OFF; 1=ON)	0528	Send/read tuner auto start set (0=OFF, 1=ON)		
50	Dial lock (0=OFF; 1=ON)	0529	Send/read PTT tune set (0=OFF, 1=ON)		
19	00	Read the transceiver ID	0530	Send/read antenna selection (0=OFF, 1=Manual, 2=Auto)	
1A	00	Send/read memory contents (see p. 114 for details)	0531	Send/read RTTY mark frequency (0=1275 Hz, 1=1615 Hz, 2=2125 Hz)	
	01	Send/read band stacking register contents (see p. 114 for details)	0532	Send/read RTTY shift width (0=170 Hz, 1=200 Hz, 2=425 Hz)	
	02	Send/read memory keyer contents (see p. 114 for details)	0533	Send/read RTTY keying polarity (0=Normal, 1=Reverse)	
	03	Send/read the selected filter width (0=50 Hz to 40/31=3600/2700 Hz)	0534	Send/read RTTY decode USOS (0=OFF, 1=ON)	
	04	Send/read the selected AGC time constant (0=OFF, 1=0.1/0.3 sec. to 13=6.0/8.0 sec.)	0535	Send/read RTTY decode new line code (0=CR,LF,CR+LF, 1=CR+LF)	
	0501	Send/read SSB TX Tone (Bass) level (0 =min. to 10=max.)	0536	Send/read speech language (0=English, 1=Japanese)	
	0502	Send/read SSB TX Tone (Treble) level (0=min. to 10=max.)	0537	Send/read speech speed (0=slow, 1=fast)	
	0503	Send/read MONITOR gain (0=min. to 255=max.)	0538	Send/read S-level speech (0=OFF, 1=ON)	
	0504	Send/read CW side tone gain (0=min. to 255=max.)	0539	Send/read memo pad numbers (0=5 ch, 1=10 ch)	
	0505	Send/read CW side tone gain limit (0=OFF, 1=ON)	0540	Send/read main dial auto TS (0=OFF, 1=Low, 2=High)	
	0506	Send/read beep gain (0=min. to 255=max.)	0541	Send/read mic. up/down speed (0=Low, 1=High)	
	0507	Send/read beep gain limit (0=OFF, 1=ON)	0542	Send/read CI-V transceive set (0=OFF, 1=ON)	
	0508	Send/read LCD contrast (0=0% to 255=100%)	0543	Send/read CI-V 731 mode set (0=OFF, 1=ON)	
	0509	Send/read LCD backlight (0=0% to 255=100%)			
	0510	Send/read LCD horizontal position (0=1 to 7=8)			
	0511	Send/read switch backlight (0=1 to 7=8)			
0512	Send/read display type (0=A, 1=B, 2=C, 3=D, 4=E, 5=F, 6=G, 7=H)				
0513	Send/read display font (0=Basic1, 1=Basic2, 2=Pop, 3=7seg, 4=Italic1, 5=italic2, 6=Classic)				
0514	Send/read memory name (0=OFF, 1=ON)				
0515	Send/read my call setting (10-character: see p. 114)				
0516	Send/read current time (0000 to 2359)				

•Command table (continued)

Command	Sub command	Description
1A	0544	Send/read TX spectrum scope set (0=OFF, 1=ON)
	0545	Send/read spectrum scope max. hold set (0=OFF, 1=ON)
	0546	Send/read voice auto monitor set (0=OFF, 1=ON)
	0547	Send/read cut number style (0=Normal, 1=190→ANO, 2=190→ANT, 3=90→NO, 4=90→NT)
	0548	Send/read count up trigger channel (1=M1, 2=M2, 3=M3, 4=M4)
	0549	Send/read present number (1=9999)
	0550	Send/read CW keyer repeat time (1=1 sec. to 60=60 sec.)
	0551	Send/read CW keyer dot/dash ratio (28=1:1:2.8 to 45=1:1:4.5)
	0552	Send/read rise time (0=2 msec., 1=4 msec., 2=6 msec., 3=8 msec.)
	0553	Send/read paddle polarity (0=Normal, 1=Reverse)
	0554	Send/read keyer type (0=Straight, 1=Bug-key, 2=ELEC-Key)
	0555	Send/read mic. up/down keyer set (0=OFF, 1=ON)
	0556	Send/read scan speed (0=low, 1=high)
	0557	Send/read scan resume (0=OFF, 1=ON)
	0558	Send/read VOX gain (0=0% to 255=100%)
	0559	Send/read anti VOX gain (0=0% to 255=100%)
	0560	Send/read VOX delay (0=0.0 sec. to 20=2.0 sec.)
	0561	Send/read RTTY filter bandwidth (0=250 Hz, 1=300 Hz, 2=350 Hz, 3=500 Hz, 4=1 kHz)
	0562	Send/read twin peak filter (0=OFF, 1=ON)
	0563	Send/read timer functions (0=OFF, 1=ON)
	0564	Send/read DSP filter type (0=SSB: sharp; CW: sharp, 1=SSB: sharp; CW: soft, 2=SSB: soft CW: sharp, 3=SSB: soft CW: soft)
	0565	Send/read quick RIT/ΔTX clear function (0=OFF, 1=ON)
	0566	Send/read SSB/CW synchronous tuning function (0=OFF, 1=ON)
	0567	Send/read CW normal side set (0=LSB, 1=USB)
	0568	Send/read external keypad type (0=OFF, 1=Keyer send, 2=Voice play (Tx), 3=Auto)
	0569	Send/read NB level (0=0% to 255=100%)

Command	Sub command	Description
1A	0570	Send/read SSB transmit bandwidth for WIDE setting (Low: 100/300/500 Hz, High: 2500/2700/2900 Hz)
	0571	Send/read SSB transmit bandwidth for MID setting (Low: 100/300/500 Hz, High: 2500/2700/2900 Hz)
	0572	Send/read SSB transmit bandwidth-NAR setting (Low: 100/300/500 Hz, High: 2500/2700/2900 Hz)
	0573	Send/read clock2 function (0=OFF, 1=ON)
	0574	Send/read offset time for clock2 (240001=-24:00, 240000=+24:00)
	0575	Send/read screen saver setting (0=OFF, 1=15 min, 2=30 min, 3=60 min)
	0576	Send/read RTTY TX USOS (0=OFF, 1=ON)
	06	Send/read DATA mode (0=OFF, 1=ON)
	07	Send/read SSB transmit bandwidth (0=Wide, 1=Middle, 2=Narrow)
	1B	00
	01	Set tone squelch tone frequency
1C	00	Set the transceiver to receive or transmit condition (0=Rx; 1=Tx)
	01	Send/read tuner function (0=OFF, 1=ON, 2=Manual tune)

• **To send/read memory contents**

When sending or reading memory contents, additional code as follows must be added to appoint the memory channel.

➔ Additional code: 0000–0101 (0100=P1, 0101=P2)

• **Band stacking register**

To send or read the desired band stacking register's contents, combined code of the frequency band and register codes as follows are used.

For example, when sending/reading the oldest contents in the 21 MHz band, the code "0703" is used.

• **Frequency band code**

Code	Frequency band	Frequency range (unit: MHz)
01	1.8	1.800000– 1.999999
02	3.5	3.400000– 4.099999
03	7	6.900000– 7.499999
04	10	9.900000–10.499999
05	14	13.900000–14.499999
06	18	17.900000–18.499999
07	21	20.900000–21.499999
08	24	24.400000–25.099999
09	28	28.000000–29.999999
10	50	50.000000–54.000000
11	GENE	Other than above

• **Register code**

Code	Registered number
01	1 (latest)
02	2
03	3 (oldest)

• **Channel code for memory keyer**

To send or read the desired memory keyer contents, the channel and character codes as follows are used.

• **Channel code**

Code	Channel number
01	M1
02	M2
03	M3
04	M4

• **Character's code**

Character	ASCII code	Description
0–9	30–39	Numerals
A–Z	41–5A	Alphabetical characters
a–z	61–7A	Alphabetical characters
space	20	Word space
/	2F	Symbol
?	3F	Symbol
,	2C	Symbol
.	2E	Symbol
^	5E	e.g., to send \bar{B} , enter ^4254
*	2A	Inserts contact number (can be used for 1 channel only)

• **Character's code for my call**

Character	ASCII code	Description
0–9	30–39	Numerals
A–Z	41–5A	Alphabetical characters
a–z	61–7A	Alphabetical characters
space	20	Word space
–	2D	Symbol
.	2E	Symbol
/	2F	Symbol

• **FM split frequency (HF/50 MHz) setting**

The following data sequence is used when sending/reading the FM split frequency setting.

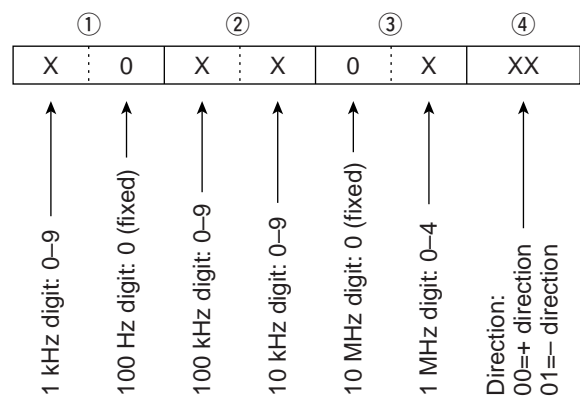

17 SPECIFICATIONS

•General

- Frequency coverage : (unit: MHz)
 - Receiver 0.030–60.000^{*1*2}
 - Transmitter 1.800–1.999^{*2}, 3.500–3.999^{*2},
5.33050^{*3}, 5.34650^{*3}, 5.36650^{*3},
5.37150^{*3}, 5.40350^{*3},
7.000–7.300^{*2}, 10.100–10.150^{*2},
14.000–14.350^{*2}, 18.068–18.168^{*2},
21.000–21.450^{*2}, 24.890–24.990^{*2},
28.000–29.700^{*2}, 50.000–54.000^{*2}
- ^{*1}Some frequency bands are not guaranteed.
- ^{*2}Depending on version. ^{*3}USA version only.
- Mode : USB, LSB, CW, RTTY, AM, FM
- No. of memory channels : 101 (99 regular, 2 scan edges)
- Antenna connector : SO-239 × 2 and phono jacks (RCA; 50 Ω)
- Temperature range : –10°C to +50°C
; +14°F to +122°F
- Frequency stability : Less than ±0.5 ppm 1 min. after power ON. (–10 to +50°C; +14 to +122°F)
- Frequency resolution : 1 Hz
- Power supply : 13.8 V DC ±15% (negative ground)
- Power consumption :
 - Transmit Max. power 23 A
 - Receive Standby 3.0 A (typ.)
 - Max. audio 3.3 A (typ.)
- Dimensions : 340(W) × 111(H) × 285(D) mm (projections not included)
13³/₈(W) × 4³/₈(H) × 11⁷/₃₂(D) in
- Weight (approx.) : 9.6 kg; 21 lb 3 oz
- ACC 1 connector : 8-pin DIN connector
- ACC 2 connector : 7-pin DIN connector
- CI-V connector : 2-conductor 3.5 (d) mm (1/8")
- Display : 5-inch (diagonal) TFT color LCD

•Transmitter

- Output power (continuously adjustable):
 - SSB/CW/RTTY/FM Less than 5 to 100 W
 - AM Less than 5 to 40 W
- Modulation system :
 - SSB PSN modulation
 - AM Low power modulation
 - FM Phase modulation
- Spurious emission : 50 dB (HF bands)
60 dB (50 MHz band)
- Carrier suppression : 40 dB
- Unwanted sideband suppression : 55 dB
- ΔTX variable range : ±9.999 kHz
- Microphone connector : 8-pin connector (600 Ω)
- ELEC-KEY connector : 3-conductor 6.35(d) mm (1/4")
- KEY connector : 3-conductor 6.35(d) mm (1/4")
- SEND connector : Phono jack (RCA)
- ALC connector : Phono jack (RCA)

•Receiver

- Receive system : Triple conversion superheterodyne system
- Intermediate frequencies :
 - 1st 64.455 MHz
 - 2nd 455 kHz
 - 3rd 36 kHz
- Sensitivity (typical) :
 - SSB, CW, RTTY 0.16 μV (1.80–29.99 MHz)^{*1}
 - (10 dB S/N) 0.13 μV (50.0–54.0 MHz)^{*2}
 - AM (10 dB S/N) 13 μV (0.5–1.799 MHz)
2 μV (1.80–29.99 MHz)^{*1}
1 μV (50.0–54.0 MHz)
 - FM (12 dB SINAD) 0.5 μV (28.0–29.99 MHz)^{*1}
0.32 μV (50.0–54.0 MHz)^{*2}
- ^{*1}Pre-amp 1 is ON, ^{*2}Pre-amp 2 is ON
- Squelch sensitivity (Pre-amp: OFF):
 - SSB, CW, RTTY Less than 5.6 μV
 - FM Less than 1 μV
- Selectivity :
 - SSB, RTTY More than 2.4 kHz/–6 dB
 - (BW: 2.4 kHz) Less than 3.6 kHz/–60 dB
 - CW (BW: 500 Hz) More than 500 Hz/–6 dB
 - Less than 700 Hz/–60 dB
 - AM (BW: 6 kHz) More than 6.0 kHz/–6 dB
 - Less than 15.0 kHz/–60 dB
 - FM (BW: 15 kHz) More than 12.0 kHz/–6 dB
 - Less than 20.0 kHz/–60 dB
- Spurious and image rejection ratio : More than 70 dB (except IF through on 50 MHz band)
- AF output power : More than 2.0 W at 10% distortion with an 8 Ω load
- RIT variable range : ±9.999 kHz
- PHONES connector : 3-conductor 6.35 (d) mm (1/4")
- External SP connector : 2-conductor 3.5 (d) mm (1/8")/8 Ω

•Antenna tuner

- Matching impedance range:
 - HF bands 16.7 to 150 Ω unbalanced (Less than VSWR 3:1)
 - 50 MHz band 20 to 125 Ω unbalanced (Less than VSWR 2.5:1)
- Minimum operating input power : 8 W
- Tuning accuracy : VSWR 1.5:1 or less
- Insertion loss (after tuning) : Less than 1.0 dB

All stated specifications are typical and subject to change without notice or obligation.

IC-PW1/EURO HF/50 MHz ALL BAND 1 kW LINEAR AMPLIFIER



Full-duty 1 kW linear amplifier including an automatic antenna tuner. Has automatic tuning and band selection capability. Full break-in (QSK) operation is possible. The amplifier/power supply unit and the remote control unit are separated.

PS-125 DC POWER SUPPLY



Light weight switching regulator system power supply.

- Output voltage: 13.8 V DC
- Max. current drain: 25 A

AH-4 HF/50 MHz AUTOMATIC ANTENNA TUNER



Specially designed to tune a long wire antenna for portable or mobile HF operation. The PTT tuner start function provides simple operation.

- Input power rating: 120 W

AH-2b ANTENNA ELEMENT



A 2.5 m long antenna element for mobile operation with the AH-4.

- Frequency coverage: 7–54 MHz bands with the AH-4

SM-20 DESKTOP MICROPHONE



Unidirectional, electret microphone for base station operation. Includes [UP]/[DOWN] switches and a low cut function.

SP-23 EXTERNAL SPEAKER



4 audio filters; headphone jack; can connect to 2 transceivers.

- Input impedance: 8 Ω
- Max. input power: 4 W

CT-17 CI-V LEVEL CONVERTER



For remote transceiver control using a personal computer. You can change frequencies, operating mode, memory channels, etc.

HM-36 HAND MICROPHONE

Hand microphone equipped with [UP]/[DN] switches.

UT-102 VOICE SYNTHESIZER UNIT

Announces the receive frequency, mode and S-meter level in a clear, electronically-generated voice, in English (or Japanese).

•About DC power supply

The use of IC-756PROIII (#33, #34, #35, #38, #40) in combination with the DC power supply complies with European Harmonised Standard regulations under the conditions listed below.

Conditions

- In combination with PS-125

INSTALLATION NOTES

For amateur base station installations it is recommended that the forwards clearance in front of the antenna array is calculated relative to the EIRP (Effective Isotropic Radiated Power). The clearance height below the antenna array can be determined in most cases from the RF power at the antenna input terminals.

As different exposure limits have been recommended for different frequencies, a relative table shows a guideline for installation considerations.

Below 30 MHz, the recommended limits are specified in terms of V/m or A/m fields as they are likely to fall within the near-field region. Similarly, the antennae may be physically short in terms of electrical length and that the installation will require some antenna matching device which can create local, high intensity magnetic fields. Analysis of such MF installations is best considered in association with published guidance notes such as the FCC OET Bulletin 65 Edition 97-01 and its annexes relative to amateur transmitter installations. The EC recommended limits are almost identical to the FCC specified 'uncontrolled' limits and tables exist that show pre-calculated safe distances for different antenna types for different frequency bands. Further information can be found at <http://www.arrl.org/>.

•Typical amateur radio installation

Exposure distance assumes that the predominant radiation pattern is forwards and that radiation vertically downwards is at unity gain (sidelobe suppression is equal to main lobe gain). This is true of almost every gain antenna today. Exposed persons are assumed to be beneath the antenna array and have a typical height to 1.8 m.

The figures assume the worst case emission of constant carrier.

For the bands 10 MHz and higher the following power density limits have been recommended:

10–50 MHz 2 W/sq m

EIRP clearance heights by frequency band

1 Watts	2.1 m
10 Watts	2.8 m
25 Watts	3.4 m
100 Watts	5 m
1000 Watts	12 m

Forward clearance, EIRP by frequency band

100 Watts	2 m
1000 Watts	6.5 m
10,000 Watts	20 m
100,000 Watts	65 m

In all cases any possible risk depends on the transmitter being activated for long periods. (actual recommendation limits are specified as an average during 6 minutes) Normally the transmitter is not active for long periods of time. Some radio licenses will require that a timer circuit automatically cuts the transmitter after 1–2 minutes etc.

Similarly some types of transmitter, SSB, CW, AM etc. have a lower 'average' output power and the assessed risk is even lower.

 Versions of the IC-756PROIII which display the "CE" symbol on the serial number seal, comply with the essential requirements of the European Radio and Telecommunication Terminal Directive 1999/5/EC.

 This warning symbol indicates that this equipment operates in non-harmonised frequency bands and/or may be subject to licensing conditions in the country of use. Be sure to check that you have the correct version of this radio or the correct programming of this radio, to comply with national licensing requirement.



**DECLARATION
OF CONFORMITY**

We Icom Inc. Japan
1-1-32, Kamiminami, Hirano-ku
Osaka 547-0003, Japan



Declare on our sole responsibility that this equipment complies with the essential requirements of the Radio and Telecommunications Terminal Equipment Directive, 1999/5/EC, and that any applicable Essential Test Suite measurements have been performed.

Düsseldorf 1st Sep. 2004
Place and date of issue

Kind of equipment: HF/50 MHz ALL MODE TRANSCEIVER

Icom (Europe) GmbH
Himmelgeisterstraße 100
D-40225 Düsseldorf

Type-designation: IC-756PROIII

Authorized representative name

Version (where applicable):

This compliance is based on conformity according to Annex III of the directive 1999/5/EC using the following harmonised standards:

H. Ikegami
General Manager

i) Article 3.1a EN 60950 + A11

ii) Article 3.1b EN 301489-1 and EN 301489-15

iii) Article 3.2 EN 301 783-2

Signature

Icom Inc.

Count on us!

IC-756PROIII
#33 (Europe)

<Intended Country of Use>

GER FRA ESP SWE
 AUT NED POR DEN
 GBR BEL ITA FIN
 IRL LUX GRE SUI
 NOR

IC-756PROIII
#34 (France)

<Intended Country of Use>

GER FRA ESP SWE
 AUT NED POR DEN
 GBR BEL ITA FIN
 IRL LUX GRE SUI
 NOR

IC-756PROIII
#35 (UK)

<Intended Country of Use>

GER FRA ESP SWE
 AUT NED POR DEN
 GBR BEL ITA FIN
 IRL LUX GRE SUI
 NOR

IC-756PROIII
#38 (Italy)

<Intended Country of Use>

GER FRA ESP SWE
 AUT NED POR DEN
 GBR BEL ITA FIN
 IRL LUX GRE SUI
 NOR

IC-756PROIII
#40 (Spain)

<Intended Country of Use>

GER FRA ESP SWE
 AUT NED POR DEN
 GBR BEL ITA FIN
 IRL LUX GRE SUI
 NOR