



INSTRUCTION MANUAL

COMMUNICATIONS RECEIVER **IC-R3**

This device complies with Part 15 of the FCC rules. Operation is subject to the following two conditions: (1) This device may not cause harmful interference, and (2) this device must accept any interference received, including interference that may cause undesired operation.

Icom Inc.



FOREWORD

READ ALL INSTRUCTIONS carefully and completely before using the receiver.

SAVE THIS INSTRUCTION MANUAL — This instruction manual contains important operating instructions for the IC-R3.

EXPLICIT DEFINITIONS

The explicit definitions below apply to this instruction manual.

WORD	DEFINITION
 WARNING	Personal injury, fire hazard or electric shock may occur.
CAUTION	Equipment damage may occur.
NOTE	If disregarded, inconvenience only. No risk of personal injury, fire or electric shock.



Versions of the IC-R3 which display the "CE" symbol on the serial number seal, comply with the essential requirements of the European Radio and Telecommunication Terminal Directive 1999/5/EC, and that any applicable Essential Test Suite measurements have been performed.

CAUTIONS

 **WARNING! NEVER** operate the receiver with a headset or other audio accessories at high volume levels. Hearing experts advise against continuous high volume operation. If you experience a ringing in your ears, reduce the volume level or discontinue use.

AVOID using or placing the receiver in direct sunlight or in areas with temperatures below -10°C ($+14^{\circ}\text{F}$) or above $+60^{\circ}\text{C}$ ($+140^{\circ}\text{F}$).

Even when the receiver power is OFF, a slight current still flows in the circuits. Remove batteries from the receiver when not using it for a long time, otherwise, the installed batteries will become exhausted.

REMOVE any cables from the [DC 6V] jack after operation or charging a battery pack.

LCDs are produced using high-density manufacturing technology resulting in 99.98% active dots, however, up to 0.02% of the dots may be non-active and/or continuously active. This is normal and does not indicate LCD malfunction.

For U.S.A. only

CAUTION: Changes or modifications to this device, not expressly approved by Icom Inc., could void your authority to operate this device under FCC regulations.

SUPPLIED ACCESSORIES

Accessories included with the receiver:	Qty.
① Antenna (FA-B03RE)	1
② Belt clip	1
③ Battery spacer	1
④ Battery pack* (BP-206)	1
⑤ Wall charger* (BC-153A/D)	1

(The shape of the BC-153A and BC-153D are different.)
*Not supplied with some versions.

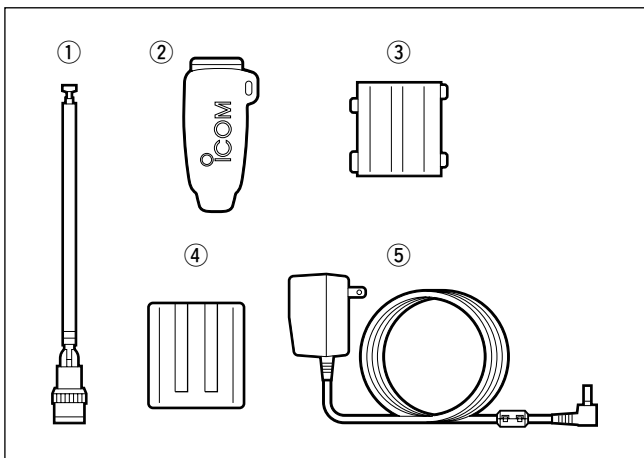

OPERATING THEORY

Electromagnetic radiation which has frequencies of 20,000 Hz (20 kHz*) and above is called radio frequency (RF) energy because it is useful in radio transmissions. The IC-R3 receives RF energy from 0.495 MHz* to 2450.00 MHz and converts it into audio frequency (AF) energy which in turn actuates a loudspeaker to create sound waves. AF energy is in the range of 20 to 20,000 Hz.

*kHz is an abbreviation of kilohertz or 1000 hertz, MHz is abbreviation of megahertz or 1,000,000 hertz, where hertz is a unit of frequency.

OPERATING NOTES

The IC-R3 may receive its own oscillated frequency, resulting in no reception or only noise reception, on some frequencies.

The IC-R3 may receive interference from extremely strong signals on different frequencies or when using an external high-gain antenna.

TABLE OF CONTENTS

1 ACCESSORY ATTACHMENT	1	■ Memory bank selection	16	13 OTHER FUNCTIONS	38–45
2 PANEL DESCRIPTION	2–6	■ Memory clear	16	■ Set mode	38
■ Panel description	2	■ Memory names	17	■ Dial select step	39
■ Function display	4	6 SCAN OPERATION	18–24	■ Beep tones	40
■ Dual LCD	6	■ Scan types	18	■ Auto power-off function	40
3 FREQUENCY AND CHANNEL		■ Full/band/programmed scan	19	■ Power saver	41
SETTING	7–9	■ Memory (bank) scan	20	■ Monitor switch action	41
■ VFO and memory channels	7	■ Selecting scan edges	21	■ Dial speed acceleration	42
■ Operating band selection	7	■ Skip channel setting	22	■ Lock function effect	42
■ Setting a frequency	8	■ Scan resume condition	22	■ Display mode selection	43
■ Setting a tuning step	8	■ Frequency skip function	24	■ Display contrast	43
■ Selecting a memory channel	9	7 PRIORITY WATCH	25–27	■ Display brightness	44
■ Lock function	9	■ Priority watch types	25	■ Display background color	44
■ Attenuator function	9	■ Priority watch operation	26	■ Cloning function	45
4 BASIC OPERATION	10–13	8 SUBAUDIBLE TONE		■ Partial reset	45
■ Receiving	10	OPERATION	28–30	■ Total reset	45
■ Setting volume level	11	■ Tone squelch operation	28	14 BATTERY CHARGING	46–47
■ Setting squelch level	11	■ Pocket beep operation	29	■ Battery cautions	46
■ Monitor function	12	■ Tone scan	30	■ Battery charging	46
■ Receive mode selection	12	9 DUPLEX OPERATION	31–32	15 OPERATION FLOW CHART	48–49
■ Display backlighting	13	10 BAND SCOPE	33	16 TV FREQUENCY TABLE	50–53
5 MEMORY CHANNELS	14–17	11 TV OPERATION	34–36	17 SPECIFICATIONS AND	
■ General	14	■ TV operation	34	OPTIONS	54–55
■ Programming during selection	14	■ ATV operation	36	18 TROUBLESHOOTING	56
■ Programming after selection	15	12 DIRECTION FINDING	37	19 QUICK REFERENCE	57–58
■ Transferring memory contents to another memory	15				

ACCESSORY ATTACHMENT

1

◆ Antenna

Insert the supplied antenna into the antenna connector and screw down the antenna as shown at right.

Keep the jack cover attached when jack is not in use to avoid bad contacts from dust and moisture.

Commercially available antennas (BNC) may increase receiver performance.

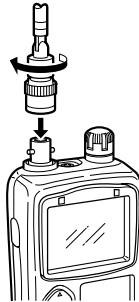

Keep battery contacts clean. It's a good idea to clean battery terminals once a week.

◆ Belt clip

Conveniently attaches to your belt.

Slide the belt clip into the plastic loop on the back of the receiver.

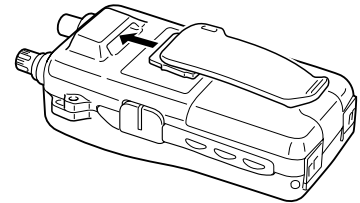

◆ Battery installation

- ① Remove the battery cover from the receiver.
- ② For alkaline battery use, attach the supplied battery spacer.
- ③ Install 3 R6 (AA) size alkaline batteries or Li-Ion battery pack (BP-206; p. 46).
 - Be sure to observe the correct polarity.
 - Charge Li-Ion battery pack before use.

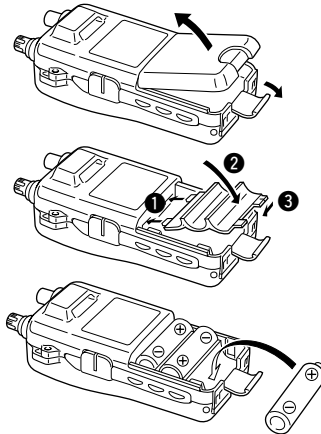

◆ Handstrap (not supplied from Icom)

Slide a commercially available handstrap through the loop on the side of the receiver or belt clip as illustrated below. Facilitates carrying.

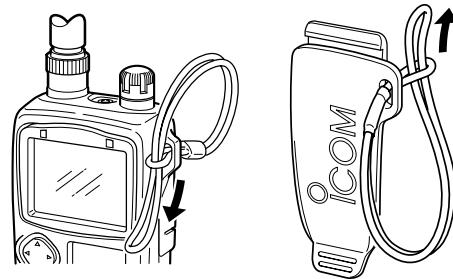

■ Panel description

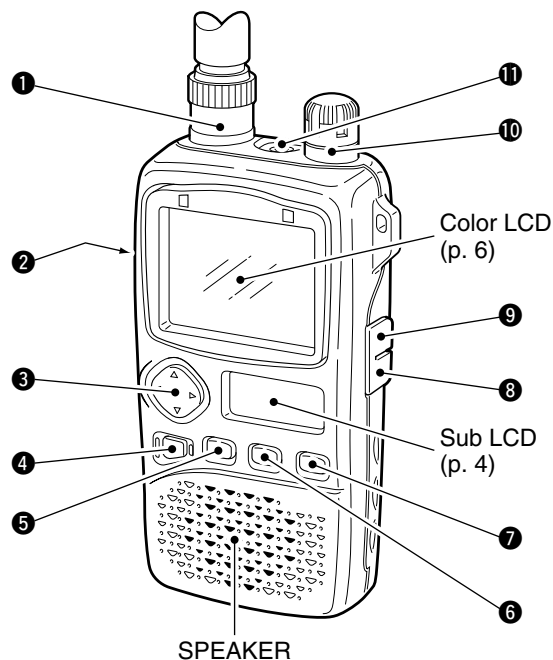

- 1 ANTENNA CONNECTOR** (p. 1)
Connects the supplied antenna.

2 FUNCTION SWITCH [FUNC]

While pushing this switch, other switches and tuning dial perform secondary functions.

- “Push [FUNC] + a switch” means “while pushing the [FUNC] switch, push the switch” as indicated by the mark e.g. [↕] etc.

3 MULTI FUNCTION SWITCH [MULTI]

- ➔ Push [↕] to adjust the audio level. (p. 11)
- ➔ Push [FUNC] + [↕] to toggle between AM TV (frequency selection), amateur TV (ATV-type) and WFM/FM/AM modes when the color LCD is OFF. (p. 34)
- ➔ Push [FUNC] + [↕] for 2 sec. to toggle the color LCD ON and OFF (p. 6, 30 MHz and above only).
- ➔ Push [FUNC] + [↕] to select color LCD function when the color LCD is ON. (p. 6)
- ➔ Push [↔] to select the operating band (VHF, UHF, etc.) in VFO mode. (p. 7)
 - Broadcast, HF, 50 MHz, FM broadcast, VHF avionics, 144 MHz, 300 MHz, 400 MHz, 800 MHz, 1200 MHz, 2400 MHz and TV bands (channel selection) can be selected.
- ➔ Push [FUNC] + [↔] to select the dial select step. (p. 39)
- ➔ Push [↔] for 2 sec. to start a scan. (pgs. 19, 20)
- ➔ Push [FUNC] + [↔] for 2 sec. to start a tone scan. (p. 30)

▨ Push [↕] means push ☺ up or down; and push [↔] means push ☺ left or right.

4 POWER SWITCH [POWER]

Push for 2 sec. to toggle the receiver power ON and OFF.

5 VFO/MEMORY SWITCH [V/M (SKIP)]

- ➔ Push [V/M] to toggle between VFO and memory modes. (p. 7)
- ➔ Push [V/M] for 1 sec. to enter memory write mode.
- ➔ Push [V/M] for 2 sec. to write the operating frequency into the selected memory channel in VFO mode. Keep pushing for 2 sec. or more to automatically select the next memory channel, if desired. (p. 14)
- ➔ Push [FUNC] + [(V/M) SKIP] to toggle the frequency skip function ON or OFF in VFO mode. (p. 24)
- ➔ Push [FUNC] + [(V/M) SKIP] to toggle the channel as skip, program skip or non-skip channel in memory mode. (p. 22)
- ➔ Push [FUNC] + [(V/M) SKIP] for 2 sec. to program the memory name while displaying the memory channel in the color LCD. (p. 17)

6 MODE SWITCH [MODE (SET)]

- ➔ Push [MODE] to select the receive mode. (p. 12)
- ➔ Push and hold [MODE] to enter tuning step setting condition and rotate the tuning dial to select the tuning step. (p. 8)
- ➔ Push [FUNC] + [(MODE) SET] to enter set mode. (p. 38)
- ➔ Push [FUNC] + [(MODE) SET] for 2 sec. to toggle the lock function ON and OFF. (pgs. 9, 24)

7 MONITOR SWITCH [SQL (ATT)]

- ➔ Push and hold to temporarily open the squelch and monitor the operating frequency. (pgs. 12, 41)

- ➔ While pushing [SQL], rotate the tuning dial to set the squelch threshold level. (p. 11)
- ➔ Push [FUNC] + [(SQL) ATT] to enter the attenuator setting condition and rotate the tuning dial to set the attenuation level. (p. 9)

8 EXTERNAL DC POWER JACK [DC 6V]

Allows operating of the repeater and charging of the BP-206 using the BC-153A/D wall charger, or using an optional CP-18A/E cigarette lighter cable.

9 AUDIO AND VIDEO OUTPUT JACK [A/V OUT]

Outputs a composite video and audio signals. (p. 5)

10 TUNING DIAL [DIAL]

- ➔ Rotate [DIAL] to set operating frequencies, memory channels, set mode contents, etc. (pgs. 7, 38)
- ➔ While scanning, changes the scanning direction. (p. 19)
- ➔ While pushing [SQL], sets the squelch level. (p. 11)
- ➔ While pushing [FUNC], sets the operating frequency in 100 kHz, 1 MHz or 10 MHz steps in VFO mode. (pgs. 8, 39)
- ➔ While pushing [FUNC], sets the memory bank in memory mode. (p. 16)
- ➔ While pushing [↔], selects programmed scan bank or memory bank in VFO or memory mode, respectively. Release [↔] to start the scan. (pgs. 19, 20)

11 EXTERNAL SPEAKER JACK [SP]

Connects an optional earphone or headphone. The internal speaker will not function when any external equipment is connected. (See p. 55 for a list of available options.)

2 PANEL DESCRIPTION

■ Function display

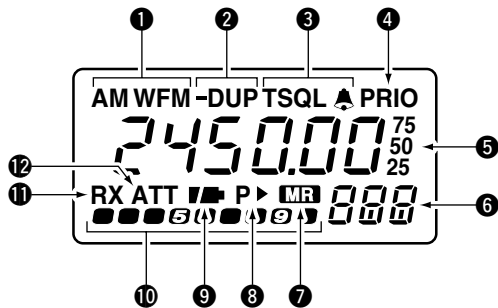

1 RECEIVE MODE INDICATORS (p. 12)

Show the receive mode.

- AM, FM and WFM are available.

2 DUPLEX INDICATORS (p. 31)

Appear when semi-duplex operation (repeater operation) is in use.

- “-DUP” appears when minus duplex is selected; “DUP” only, appears when plus duplex is selected.

3 TONE INDICATORS (p. 28)

- ↳ “TSQL” appears when the tone squelch function is activated and “TSQL 📢” appears during pocket beep operation.
- ↳ “📢” flashes when the correct tone is received during pocket beep operation.

4 PRIORITY WATCH INDICATOR (p. 25)

Appears when priority watch is in use.

5 FREQUENCY READOUT

Shows the operating frequency, set mode contents, etc.

- The smaller “75,” “50” and “25” to the right of the readout indicate 7.5, 5.0 and 2.5 kHz, respectively.
- The decimal point of the frequency flashes during scan.

6 MEMORY CHANNEL READOUT (p. 7)

Shows the memory channel number, 8 memory banks (A–H), etc.

- The 1st digit (A–H) of regular memory indicates memory bank.
- ‘tV0’ to ‘tV9’ indicate AM TV memory channels. (p. 35)
- ‘t00’ to ‘t49’ indicate FM TV memory channels. (p. 36)
- Suffix ‘A’ and ‘b’ indicate scan edge memory channels.

7 MEMORY MODE INDICATOR (p. 7)

Appears when a memory channel is selected.

8 SKIP SCAN INDICATOR (pgs. 22, 24)

- “▶” appears when the selected memory channel is set as a skip channel in memory mode.
- “P▶” shows that the skip frequency function is turned ON or OFF in VFO mode.
- “P▶” appears when the selected memory channel is set to be skipped during VFO scan (full, band and programmed scan) in memory mode.

9 BATTERY INDICATORS

- Both segments appear when the batteries have enough capacity.
- Only the right segment appears when the batteries are nearing exhaustion.
 - “Low V” appears when battery replacement is necessary and the color LCD is ON.
 - The U.S.A. version automatically turns itself OFF when the receiver detects that battery replacement is necessary.

10 S (SIGNAL) INDICATORS

Show the relative signal strength while receiving.

11 BUSY INDICATOR

“RX” appears when receiving a signal or when the squelch is open.

12 ATTENUATOR INDICATOR (p. 9)

Appears when the attenuator function is in use.

• Audio and video output jack information

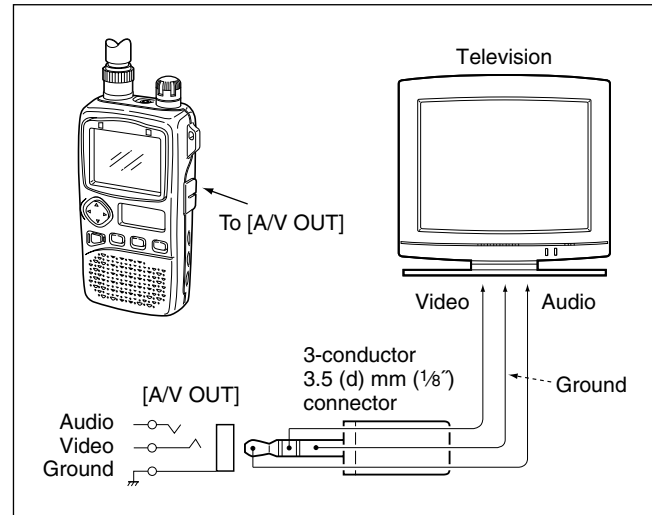

- Video output impedance : 75 Ω , 1 V p-p typical
- Audio output impedance : 1 k Ω , 300 mV rms typical

2 PANEL DESCRIPTION

■ Dual LCD

The receiver has dual LCDs for versatile display selection.

The color LCD has 5 screens and 1 optional screen as follows:

simple, multi-function, band scope, direction finding, TV (frequency selection) and amateur TV* screen.

/// * Amateur TV screen can be selected for the ATV-type and 1200/2400 MHz bands only.

/// The color LCD can be used when the operating frequency is 30 MHz and above.

- ① Push [FUNC] + [↑] for 2 sec. to turn the color LCD ON, if desired.
- ② Push [FUNC] + [↑] momentarily one or more times to toggle the screen of the color LCD.

/// While the color LCD is in use, the sub LCD displays the voltage of the power source.



Appears when simple screen is selected.

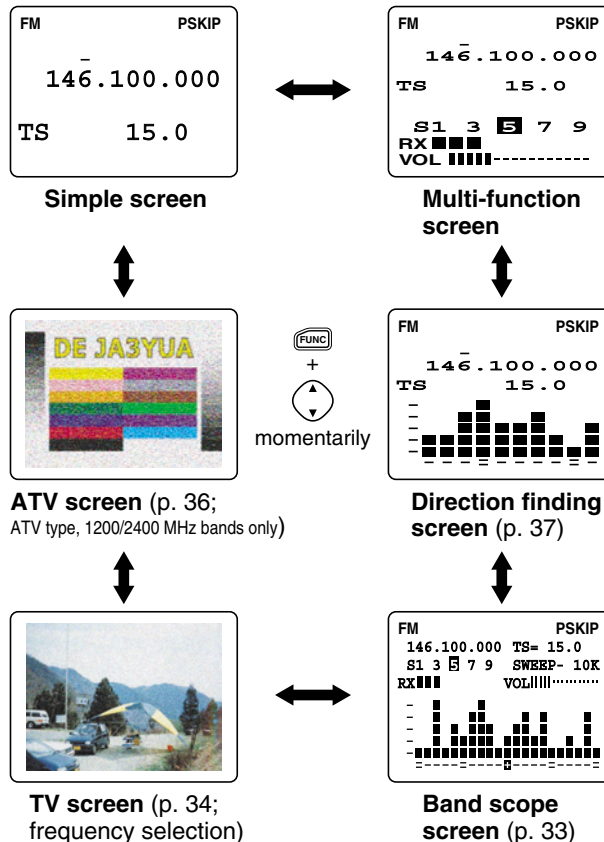

■ VFO and memory channels

This receiver has 2 normal operating modes: VFO mode and memory mode.

VFO mode is used for setting a desired frequency within the frequency coverage.

➔ Push [V/M] to select VFO mode.



Memory mode is used for operation of memory channels which have programmed frequencies.

➔ Push [V/M] to select memory mode.

- "M" or "M:" appears when a memory channel is selected.

- To program a memory, refer to p. 14.

- TV band and ATV (ATV type) have separate memory channels (pgs. 35, 36)

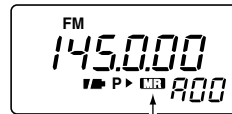

"M" or "M:" appears.

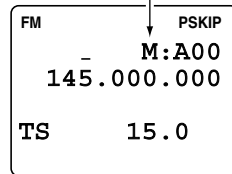

What is VFO?

VFO is an abbreviation of Variable Frequency Oscillator. Frequencies for receiving are generated and controlled by the VFO.

■ Operating band selection

The receiver can receive the broadcast band, HF band, 50 MHz band, FM broadcast band, VHF avionics band, 144 MHz band, 300 MHz band, 400 MHz band, 800 MHz band,* 1200 MHz, 2400 MHz or TV band.

*Some frequencies cannot be received with the U.S.A. version.

➔ Push [↔] several times to select the desired band.

- When a memory channel is selected, the first push of [↔] selects VFO mode.

▨ Amateur TV screen is also selected for the ATV-type IC-R3. (p. 36)

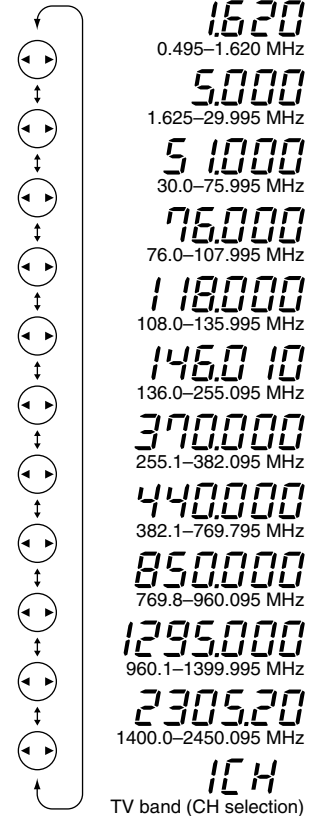

3 FREQUENCY AND CHANNEL SETTING

■ Setting a frequency

- ① Select the desired band with [↔].
- ② Rotate [DIAL] to change the frequency.
 - The frequency changes according to the preset tuning steps. See the right section for selecting the tuning step.
 - Some TV channels may be set as skip channels by default and can be selected by rotating [DIAL] while pushing [FUNC]. (p. 34).
 - Push [↔] while pushing [FUNC] to change the frequency in 100 kHz, 1 MHz or 10 MHz steps.



[DIAL] changes the frequency according to the selected tuning step.



While pushing [FUNC], [DIAL] changes the frequency in 1 MHz steps (default).

▨ The 1 MHz tuning step (dial select step) can be set to 100 kHz, 1 MHz or 10 MHz tuning steps in set mode. See p. 39 for details.

■ Setting a tuning step

Tuning steps can be selected for each band, however, the tuning step of the broadcast band is fixed to 9 kHz steps except for U.S.A. and Canada versions. The following are available.

- 5 kHz
- 6.25 kHz*
- 10 kHz
- 12.5 kHz
- 15 kHz
- 20 kHz
- 25 kHz
- 30 kHz
- 50 kHz
- 100 kHz

* Not available for 1200 MHz band.

- ① Select the desired band, except for TV band, with [↔].
- ② Rotate [DIAL] while pushing [MODE] to select the desired tuning step.

• 15 kHz tuning step (Simple screen)

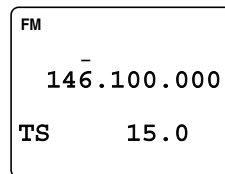

• 15 kHz tuning step (Sub LCD)

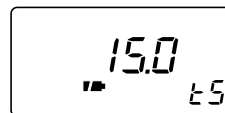

■ Selecting a memory channel

- ① Push [V/M] to select memory mode.
 - “MEM” or “M.” appears when a memory channel is selected.
- ② Rotate [DIAL] to change the indicated memory channel.
 - Only programmed memory channels can be selected.
 - Rotate [DIAL] while pushing [FUNC] to change the memory bank.

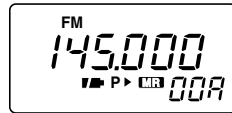

[DIAL] changes the memory channel.

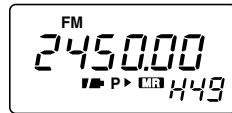

While pushing [FUNC], [DIAL] changes the memory bank.

■ Lock function

The lock function prevents accidental frequency changes and accidental function access.

- ➔ Push [FUNC] + [MODE] for 2 sec. to toggle the lock function ON and OFF.
 - [POWER], [↑(VOL)] and [SQL] can still be accessed while the lock function is ON (default).
 - Accessible switches can be set to 1 of 4 groups in set mode. See p. 42 for details.



“L” appears when the lock function is in use.

■ Attenuator function

The attenuator prevents a desired signal from distorting when very strong signals are near the desired frequency or when very strong electric fields, such as from a broadcasting station, are near your location.

The receiver has 4 attenuation levels for various operating conditions. The attenuator functions when the operating frequency is 1149.995 MHz or below.

- ① Push [FUNC] + [(SQL)ATT] to enter the attenuator setting condition.
- ② Rotate [DIAL] to set the attenuation level 1–4 or turn the attenuator function OFF.
 - “ATT1” – “ATT4” appears in the color LCD when the color LCD is ON; “ATT” appears in the sub display when the color LCD is OFF.
- ③ Push [(SQL)ATT] to exit the attenuator setting condition.

Shows when the attenuator (level 4) is in use.



Shows when the attenuator is in use.

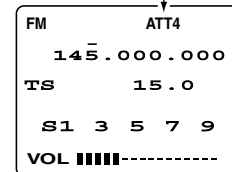

■ Receiving

Make sure a charged battery pack or alkaline batteries are installed. (pgs. 1, 46)

- ① Push [POWER] for 2 sec. to turn power ON.
- ② Push [↕] to set the desired audio level.
 - One of the LCDs shows the volume level while setting. See the next page for details.
- ③ Push [↔] to select an operating band. (p. 7)
- ④ Rotate [DIAL] to set an operating frequency. (p. 8)
- ⑤ Set the squelch level.
 - While pushing [SQL], rotate [DIAL].
 - The first click of [DIAL] indicates the current squelch level.
 - “LEVEL1” is loose squelch and “LEVEL9” is tight squelch.
 - “AUTO” indicates automatic level adjustment with a noise pulse count system.
 - Push and hold [SQL] to open the squelch manually. (default behaviour; p. 41)
- ⑥ When a signal is received:
 - Squelch opens and audio is emitted from the speaker.
 - The S indicators show the relative signal strength.
 - The busy indicator appears when receiving a signal or when the squelch is open.

/// For U.S.A. version

The U.S.A. version automatically turns itself OFF when the receiver detects that battery replacement is necessary. Replace the battery or charge the battery pack in this case.

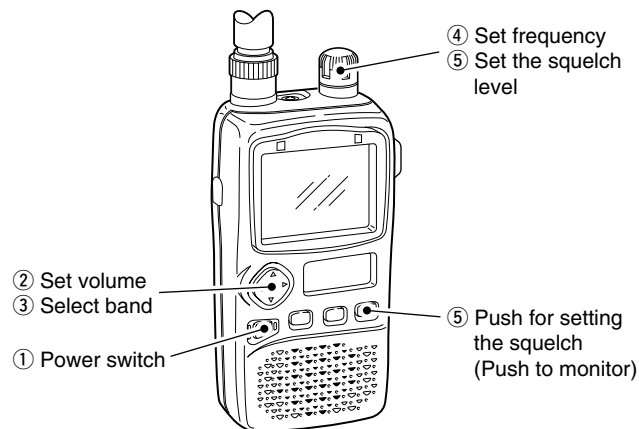

/// For non-U.S.A. versions

If the display mode selection is set as 'manual' (p. 43) with the color LCD ON, the receiver may not be able to turn itself OFF when the battery becomes exhausted. Replace the battery and turn power OFF in this case.

■ Setting volume level

The audio level can be adjusted through 32 levels.

- ➔ Push [↕] to set the desired audio level.
 - Beep tone sounds while setting. This indicates the approximate sound level. (default behaviour; p. 40)
 - Pushing and holding these keys changes the audio level continuously.
 - One of the LCDs shows the volume level while setting.

INDICATION (Sub LCD)	AUDIO LEVEL
- - - - -	Min. setting (no audio)
0 _ _ _ _	:
00 _ _ _	Initial setting
000 _ _	:
0000 _	:
00000 _	:
000000	Max. setting

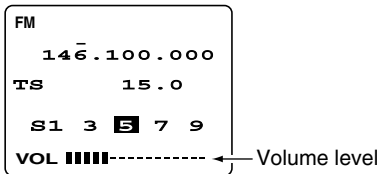

■ Setting squelch level

The squelch circuit mutes the received audio signal depending on the signal strength. The receiver has 9 squelch levels, a continuously open setting and an automatic squelch setting.

- ➔ While pushing [SQL], rotate the [DIAL] to select the squelch level.
 - The first click of [DIAL] indicates the current squelch level.
 - “LEVEL1” is loose squelch and “LEVEL9” is tight squelch.
 - “AUTO” indicates automatic level adjustment with a noise pulse count system.
 - “OPEN” indicates continuously open setting.



Automatic squelch

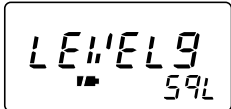

Maximum level

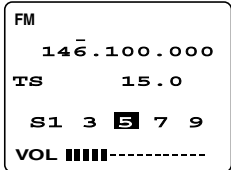

4 BASIC OPERATION

■ Monitor function

This function is used to listen to weak signals or to open the tone squelch manually.

- ➔ Push and hold [SQL] to monitor the operating frequency.
 - “RX” flashes while monitoring.

/// The [SQL] switch can be set to ‘sticky’ operation in set mode. (p. 41)

/// You can monitor duplex communication by pushing the [SQL] switch when the duplex function is in use. (p. 31)

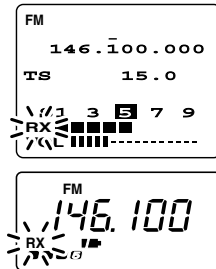

■ Receive mode selection

Receive modes are determined by the physical properties of the radio signals. The receiver has 3 receive modes: FM, AM and WFM modes. TV and ATV (ATV type only) also use WFM mode. The mode selection is stored independently in each band and memory channels.

Typically, AM mode is used for the AM broadcast stations (0.495–1.620 MHz) and air band (118–135.995 MHz), and WFM is used for FM broadcast stations (76–107.9 MHz).

- ➔ Push [MODE] one or more times to select the desired receive mode.

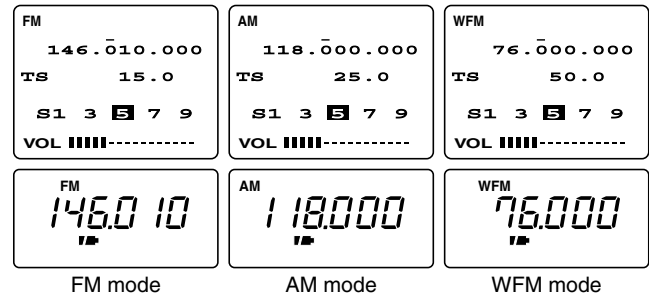

FM mode

AM mode

WFM mode

TV screens cannot be selected by pushing [MODE]. See p. 34 for TV operation details.



TV screen
frequency selection



FM TV mode
(ATV type only)

■ Display backlighting

The receiver has display backlighting with a 5 sec. timer for nighttime operation. The display backlighting can be turned ON continuously or turned OFF, if desired.

- Push any switch except [FUNC]; or, rotate [DIAL] to turn the backlighting ON.
 - When auto backlighting is set, the backlighting will automatically turn OFF when switches and [DIAL] have not been operated for 5 sec.

◆ Setting the backlighting condition

- ① Push [FUNC] + [(MODE) SET] momentarily to enter set mode.
 - Select a non-band scope screen in advance for color LCD.
- ② Rotate [DIAL] until "LIGHT" appears.
 - "LIGHT" disappears after 1 sec. and the previously selected backlighting timer and "LI" appears when color LCD is OFF.
- ③ Push [↔] or rotate the tuning dial while pushing [FUNC] to select the desired backlighting condition.
- ④ Push [(MODE) SET] to exit set mode.

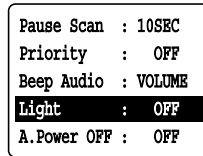
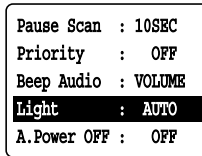
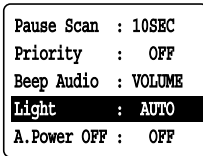

Backlighting set mode



Automatic backlighting

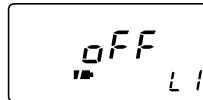

Continuously OFF

5

MEMORY CHANNELS

■ General

The receiver has 400 memory channels in 8 banks (A–H) for storage of often-used frequencies.

◆ Memory channel contents

The following information can be programmed into memory channels:

- Operating frequency (p. 8)
- Receive mode (p. 12)
- Tuning step (p. 8)
- Memory name (p. 17)
- Duplex direction (DUP or –DUP) with an offset frequency (p. 31)
- Tone squelch ON/OFF (p. 28)
- Tone squelch frequency (p. 28)
- Scan skip setting (p. 22)

■ Programming during selection

- ① Push [↔] to select an operating band.
- ② Set the desired frequency:
 - ➔ Set the frequency using [DIAL].
 - ➔ Set other data (e.g. offset frequency, duplex direction, tone squelch frequency, etc.), if required.
- ③ Push [V/M] for 1 sec. to indicate memory channels.
 - Do not hold [V/M] for more than 2 sec., otherwise the previously selected memory channel will be overwritten.
- ④ Rotate [DIAL] to select the desired channel.
 - VFO (VF), as well as regular memory channels, can be programmed in this way.
 - Rotate [DIAL] while pushing [FUNC] to select a memory bank (A–H), programmed scan edge channel or VFO (VF).
- ⑤ Push [V/M] for 1 sec. to program.
 - Keep pushing for 2 sec. or more to automatically select the next memory channel, if desired.

[EXAMPLE]: Programming ch 40 of memory bank E during selection (and ch 41 selection).

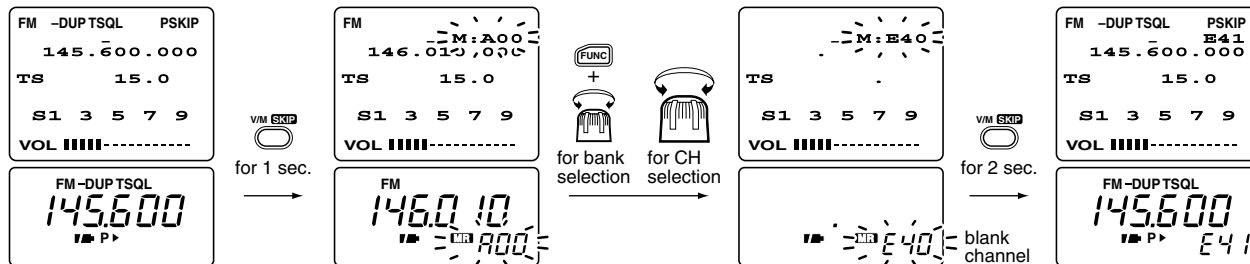

■ Programming after selection

- ① Select memory mode with [V/M].
- ② Set the memory channel to be programmed with [DIAL].
 - Rotate [DIAL] while pushing [FUNC] to select a memory bank (A–H) or programmed scan edge channel.
 - Non-programmed channels cannot be selected.
- ③ Push [V/M] to select VFO mode.
- ④ Set the desired frequency:
 - Select the desired band with [↔].
 - Set the frequency using [DIAL].
 - Set other data (e.g. offset frequency, duplex direction, tone squelch frequency, etc.), if required.
- ⑤ Push [V/M] for 2 sec. to program the selected channel.
 - Keep pushing for 2 sec. or more to automatically select the next memory channel, if desired.

■ Transferring memory contents to another memory

- ① Select memory mode with [V/M].
- ② Select the memory channel to transfer with [DIAL].
 - Rotate [DIAL] while pushing [FUNC] to select a memory bank (A–H) or programmed scan edge channel.
- ③ Push [V/M] for 1 sec. to indicate memory channels.
 - Do not hold [V/M] for more than 2 sec., otherwise the memory channel contents will be transferred to VFO.
- ④ Rotate [DIAL] to select the channel to transfer to.
 - Rotate [DIAL] while pushing [FUNC] to select a memory bank or programmed scan edge channel.
 - VFO (VF), as well as regular memory channels, can be transferred in this way.
- ⑤ Push [V/M] for 2 sec. to transfer.

[EXAMPLE]: Transferring memory channel 3 (memory bank A) to 20 (memory bank A).

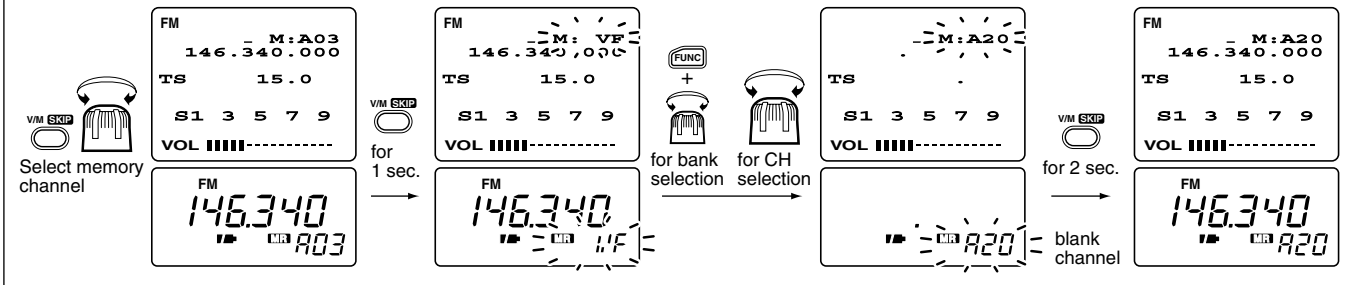

5 MEMORY CHANNELS

■ Memory bank selection

The receiver has 400 memory channels in 8 banks (A–H) for storage of often-used frequencies.

- ① Select memory mode with [V/M].
- ② Rotate [DIAL] while pushing [FUNC] to select the desired memory banks.
- ③ Rotate [DIAL] to select the desired memory channel.



■ Memory clear

Unwanted memory channels can be cleared (erased). Before clearing a memory channel, make sure it is no longer needed as cleared memories cannot be recalled.

- ① Select memory mode with [V/M].
- ② Set the memory channel to be cleared with [DIAL].
 - Rotate [DIAL] while pushing [FUNC] to select a memory bank (A–H) or programmed scan edge channel.
- ③ Select VFO mode with [V/M] and push [V/M] for 1 sec. to indicate the selected memory channel.
 - Do not hold [V/M] for more than 2 sec., otherwise the selected memory channel will be overwritten.
- ④ Push [FUNC] + [V/M] for 2 sec. to clear.
 - 3 beeps sound, then the frequency is cleared.
- ⑤ Push [MODE] to return to VFO mode.

[EXAMPLE]: Clearing memory channel 3 (memory bank A).

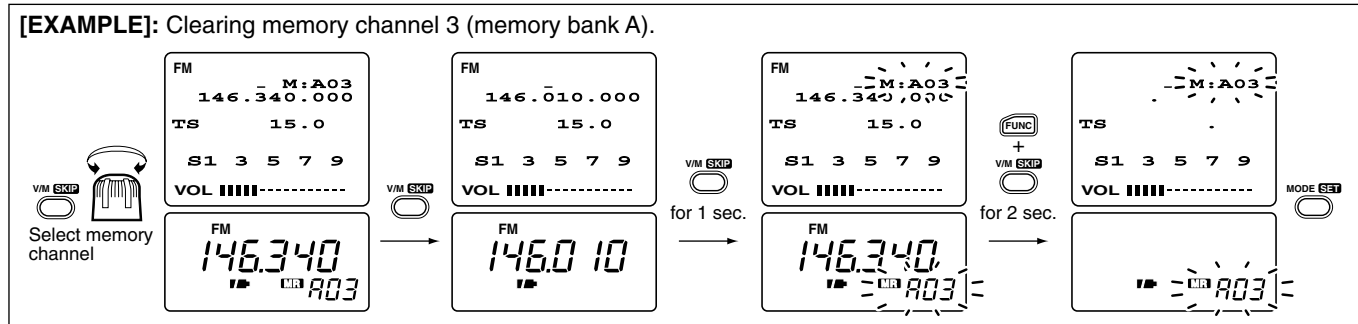

Memory names

Each memory channel and scan edge channels can be programmed with an alphanumeric name such as a repeater name, club name, etc., for easy recognition. Names can be a maximum of 6 characters—see the table at right for available characters.

The color LCD and memory names can be used when the operating frequency is 30 MHz and above.

- ① Push [FUNC] + [↕] for 2 sec. to turn the color LCD ON.
- ② Push [FUNC] + [↕] one or more times to select the simple or multi-function screen.
 - The memory names are available for the simple and multi-function screens only.
- ③ Select the desired memory channel.
- ④ Push [FUNC] + [(V/M) SKIP] for 2 sec. to program the memory name.
 - The first character of the name flashes.

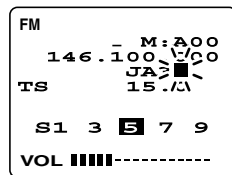
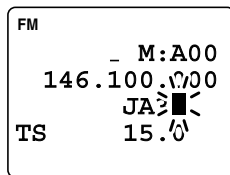

- ⑤ Rotate the tuning dial to select the desired character.
 - See the following table for a list of available characters.
- ⑥ Push [↔] (right) to advance to the next character.
 - Push [↔] (left) to select the previous character.
- ⑦ Repeat ⑤ and ⑥ until the desired name is input.
- ⑧ Push [V/M] to program the name and exit programming mode.
- ⑨ If you want to set other channels, rotate the tuning dial. Repeat ④ through ⑧ to set the desired name.

A	B	C	D	E	F	G	H	I	J
K	L	M	N	O	P	Q	R	S	T
U	V	W	X	Y	Z	a	b	c	d
e	f	g	h	i	j	k	l	m	n
o	p	q	r	s	t	u	v	w	x
y	z	0	1	2	3	4	5	6	7
8	9	?	!	\$	%	#	+	-	*
/	=	()	:	;	.	,	_	'
~	space								

▨ The memory names are automatically programmed into the memory channels.

6

SCAN OPERATION

Scan types

Up to 25 programmed scan ranges (00A/00b to 24A/24b), full scan, band scan and memory bank scan provide scanning versatility. Each scan can have skip channels programmed.

FULL SCAN (p. 19)

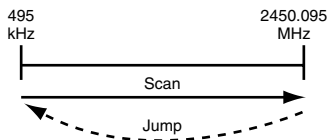

Repeatedly scans all frequencies over the entire receiver range.

U.S.A. version cannot receive some frequencies.

SELECTED BAND SCAN (p. 19)

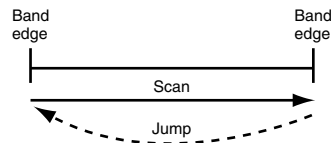

Repeatedly scans all frequencies over the entire selected band.

PROGRAMMED SCAN (p. 19)

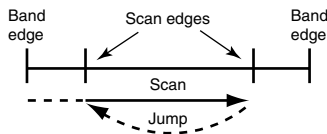

Repeatedly scans between two user-programmed frequencies. Used for checking for frequencies within a specified range such as repeater output frequencies, etc.

MEMORY (BANK) SCAN (p. 20)

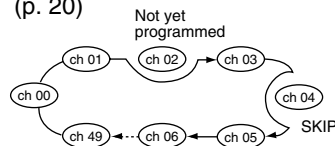

Repeatedly scans memory channels except skip channels within all programmed channels or within a memory bank (A-H).

FREQUENCY SKIP FUNCTION (p. 24)

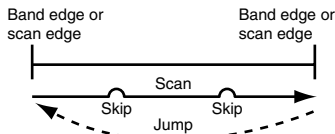

Skips unwanted frequencies that inconveniently stop scanning. This function can be turned ON and OFF in frequency skip function set mode.

MEMORY SKIP FUNCTION (p. 22)

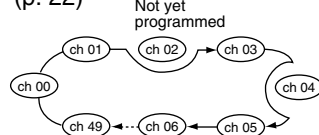

Skips unwanted memory channels that inconveniently stop scanning. Skip channels can be toggled ON and OFF by pushing [FUNC] + [(V/M) SKIP] in memory mode.

■ Full/band/programmed scan

Scanning searches for signals automatically and makes it easier to locate new stations for listening purposes, etc.

- ① Select VFO mode with [V/M].
- ② Make sure the squelch is set to the threshold point.
 - Select automatic squelch (AUTO) or a level (1–9) where the noise is just muted. (p. 10)
- ③ Push and hold [↔], then rotate [DIAL] to select desired scan edge.
 - “ALL” for full scan, “BAND” for band scan or “PROG(RAM) 0”–“PROG(RAM)24” for programmed scan. (see the next page)

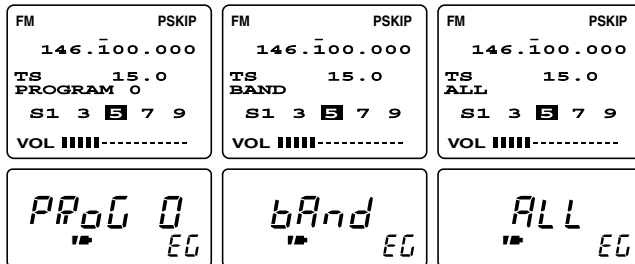

Programmed scan 0

Band scan

Full scan

- ④ Release [↔] to start the scan.
 - Decimal point(s) flashes while scanning.
 - “PSKIP” appears when the frequency skip function is turned ON. (p. 19)
 - “0P”–“24P” flash to indicate which pair of scan edges is being scanned.
 - To change the scanning direction, rotate [DIAL].
 - If the pocket beep function is activated, the receiver automatically selects the tone squelch function when a scan starts.
- ⑤ To stop the scan, push [↔] again.

▨ If the same frequencies are programmed into a pair of scan edges, programmed scan does not start.

▨ For programmed scan, scan edges must be programmed in advance. Program scan edges in the same manner of programming a memory channel (p. 14) and select a scan edge. (p. 21)

▨ A tone scan function is available to search for subaudible tones (e.g. when you want to find a subaudible tone frequency necessary to open a repeater or to open the tone squelch). See p. 30 for details.

6 SCAN OPERATION

■ Memory (bank) scan

- ① Select memory mode with [V/M].
- ② For memory bank scan, rotate [DIAL] while pushing [FUNC] to select the desired memory bank.
- ③ Make sure the squelch is set to the threshold point.
 - Select automatic squelch (AUTO) or a level (1–9) where the noise is just muted. (p. 11)
- ④ Push and hold [↔], then rotate [DIAL] to turn the memory bank scan ON or OFF.
 - “ALL” indicates all memory banks are scanned (memory bank scan OFF); “BANK” indicates the selected memory bank is scanned (memory bank scan ON).
- ⑤ Release [↔] to start the scan.
 - Decimal point(s) flashes while scanning.
 - To change the scanning direction, rotate [DIAL].
 - If the pocket beep function is activated, the receiver automatically selects the tone squelch function when a scan starts.
- ⑥ To stop the scan, push [↔] again.

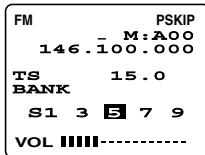

Bank scan ON

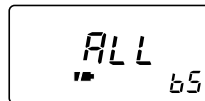
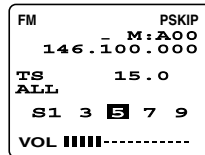

Bank scan OFF

■ Selecting scan edges

The scanning range can be set to all frequencies (full scan), a selected band (band scan) or between two user-programmed frequencies (programmed scan).

▨ The programmed scan edges can be programmed in the same manner as programming regular memory channels.
 ▨ Program the desired scan edge frequencies in a pair of programmed scan edge channels in advance. (pgs. 14, 15)

- ① Select VFO mode with [V/M].
- ② Push and hold [↔], then rotate [DIAL] to select desired scan edge.
 - “ALL” for full scan, “BAND” for band scan or “PROG(RAM) 0”– “PROG(RAM)24” for programmed scan.
- ③ Release [↔] to start the programmed scan using the selected edges.

▨ When scanning across the band as follows (programmed scan edges are set across the band), the parameters like tuning step, receive mode, offset frequency, duplex direction, etc. are used in each bands’ VFO settings instead of these scan edges.

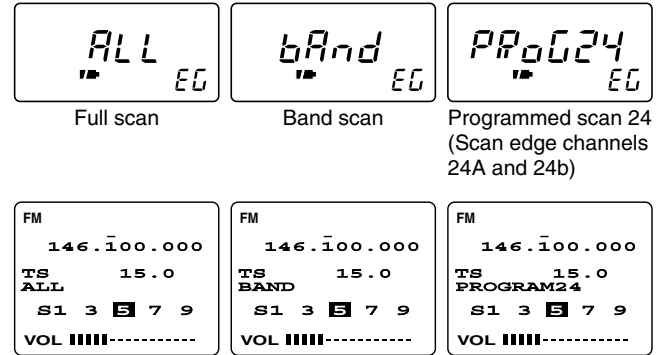

• Band ranges

BAND	FREQUENCY RANGE
Broadcast band	0.495 – 1.620 MHz
HF band	1.625 – 29.995 MHz
50 MHz band	30.0 – 75.995 MHz
FM broadcast band	76.0 – 107.995 MHz
VHF avionics band	108.0 – 135.995 MHz
144 MHz band	136.0 – 255.095 MHz
300 MHz band	255.1 – 382.095 MHz
400 MHz band	382.1 – 769.795 MHz
800 MHz band	769.8 – 960.095 MHz
1200 MHz band	960.1 – 1399.995 MHz
2400 MHz band	1400.0 – 2450.095 MHz

6 SCAN OPERATION

■ Skip channel setting

Memory channels can be set to be skipped for memory skip scan. In addition, memory channels can be set to be skipped for both memory skip scan and frequency skip scan. These are useful to speedup the scan interval.

- ① Select memory mode with [V/M].
- ② Rotate [DIAL] to select a memory channel to be programmed as a skip channel.
- ③ While pushing [FUNC], push [(V/M)SKIP] one or more times to select a condition.
 - No indication : channel will not be skipped.
 - “SKIP” or “▶” appears : channel skipped during memory scan.
 - “PSKIP” or “P▶” appears: channel skipped during memory scan; frequency skipped during full, band and programmed scans.

/// This setting is effective when the frequency skip function (“PSKIP” or “P▶”) is turned ON. See p. 24 for details.

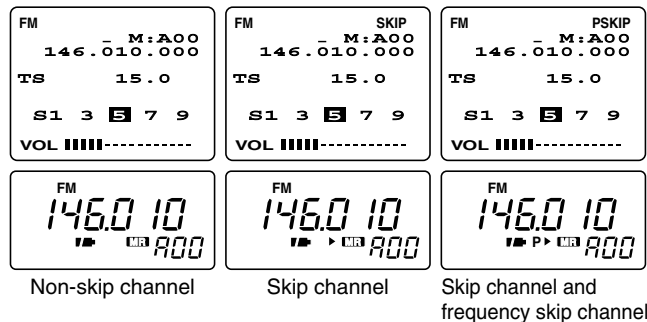

■ Scan resume condition

◇ Setting the scan pause time

The scan pauses when receiving signals according to the scan pause time. It can be set from 2–20 sec. or unlimited.

- ① Push [FUNC] + [(MODE)SET] momentarily to enter set mode.
 - Select a non-band scope screen in advance for color LCD.
- ② Rotate [DIAL] until “Pause Scan” or “PAUSE” appears.
 - “PAUSE” disappears after 1 sec. and the previously selected scan pause time and “PA” appears when color LCD is OFF.

- Push [↔] or rotate the tuning dial while pushing [FUNC] to select the desired scan pause time.
 - “2SEC”–“20SEC” : scan pauses for 2–20 sec. on a received signal.
 - “HOLD” : scan pauses on a received signal until it disappears.
- Push [(MODE)SET] to exit set mode.

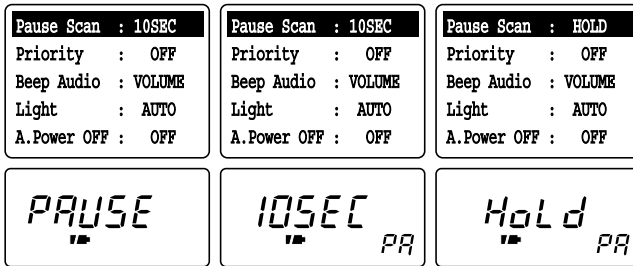

Scan pause time set mode

10 sec. pause time

Pause scan

◆ Setting the scan resume time

The scan restarts after a signal disappears according to the resume time. It can be set from 0–5 sec. or unlimited.

- Push [FUNC] + [(MODE)SET] momentarily to enter set mode.
 - Select a non-band scope screen in advance for color LCD.

- Rotate [DIAL] until “Scan Resume” or “RESUmE” appears.
 - “RESUmE” disappears after 1 sec. and the previously selected scan resume time and “RE” appears when color LCD is OFF.
- Push [↔] or rotate the tuning dial while pushing [FUNC] to select the desired scan resume time.
 - “1SEC”–“5SEC” : scan restarts 1–5 sec. after the signal disappears.
 - “0SEC” : scan restarts immediately after the signal disappears.
 - “HOLD” : scan restarts by rotating [DIAL] only.
- Push [(MODE)SET] to exit set mode.

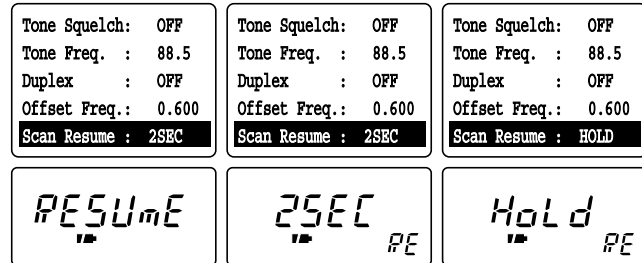

Scan resume time set mode

2 sec. resume time

Scan resumes by rotating [DIAL] only.

6 SCAN OPERATION

■ Frequency skip function

◇ Programming a skip frequency

Unwanted frequencies can be skipped and programmed as skip channels when full scan, band scan or programmed scan is pausing.

- ① Start full scan, band scan or programmed scan. (p. 19)
- ② While receiving an unwanted signal and scan pauses, push [FUNC] + [(V/M) SKIP] for 2 sec. to program the received frequency as a skip frequency.
 - The receiver emits 3 beeps and the scan resumes.
 - Non-programmed memory channels (blank channels) are used for skip frequency programming in reverse sequence.
 - To scan the skip frequency after programming, cancel the skip information (p. 22) or clear the memory channel (p. 16).

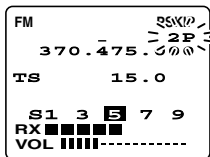

Indication while pausing

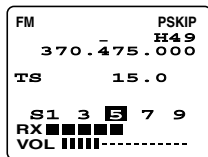

Indication while programming



◇ Frequency skip function ON/OFF

The frequency skip function can be turned OFF. In this case, the frequencies will not be skipped even if skip information is programmed and “P SKIP” or “P▶” does not appear.

- ① Select VFO mode with [V/M].
- ② Push [FUNC] + [(V/M) SKIP] to toggle the frequency skip function ON or OFF.
 - “PSKIP” or “P▶” appears when the function is turned ON.

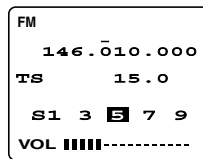

The frequency skip function is OFF.

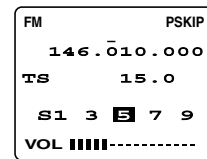

The frequency skip function is ON.

Priority watch types

Priority watch checks for signals on a frequency every 5 sec. while operating on a VFO frequency or scanning. The receiver has 3 priority watch types to suit your needs.

In addition, you can be alerted with beeps and a flashing “🔔”.

The watch resumes according to the selected scan resume condition. See p. 22 for details.

▨ If the pocket beep function is activated, the receiver automatically selects the tone squelch function when priority watch starts.

MEMORY CHANNEL WATCH (p. 26)

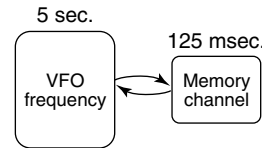

While operating on a VFO frequency, priority watch checks for a signal on the selected memory channel every 5 sec.

- A memory channel with skip information can be watched.

MEMORY SCAN WATCH (p. 26)

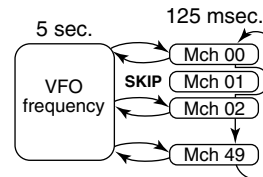

While operating on a VFO frequency, priority watch checks for signals on each memory channel in sequence.

- The memory skip function and/or memory bank scan is useful to speed up the scan.

VFO SCAN WATCH (p. 27)

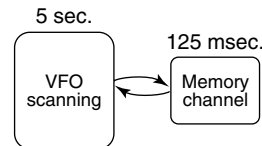



While scanning in VFO mode, priority watch checks for signals on the selected memory channel every 5 sec.

Priority watch operation

Memory channel watch and memory scan watch

- ① Select VFO mode; then, set an operating frequency.
- ② Set the watching channel(s).
 - For memory channel watch:**
Select the desired memory channel.
 - For memory scan watch:**
Select memory mode; then, push [↔] for 2 sec. to start memory scan.
- ③ Push [FUNC] + [(MODE) SET] momentarily to enter set mode.
 - Select a non-band scope screen in advance for color LCD.

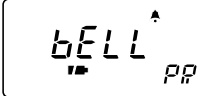
Pause Scan : 10SEC Priority : OFF Beep Audio : VOLUME Light : AUTO A.Power OFF : OFF	Pause Scan : 10SEC Priority : ON Beep Audio : VOLUME Light : AUTO A.Power OFF : OFF	Pause Scan : 10SEC Priority : BELL Beep Audio : VOLUME Light : AUTO A.Power OFF : OFF
		
Priority watch set mode	Priority watch is ON.	Priority watch with alert is ON.

- ④ Rotate [DIAL] to select “Priority” or “PRIo.”
 - “PRIo” disappears after 1 sec. and “oFF” and “PR” appears when color LCD is OFF.
- ⑤ Push [↔] or rotate the tuning dial while pushing [FUNC] to select priority watch ON or priority watch ON with alert (BELL).
 - If the pocket beep function is activated, the receiver automatically selects the tone squelch function when the priority watch is selected.
- ⑥ Push [(MODE) SET] to exit set mode and start the watch.
 - The receiver checks the memory channel frequency every 5 sec.
 - The watch resumes according to the selected scan resume condition. (p. 22)
 - If the priority watch with alert is ON, you can be alerted with beeps and a flashing “P.B” or “🔔”.
 - If the direction finding screen is selected, the receiver automatically selects the simple screen when the priority watch starts.

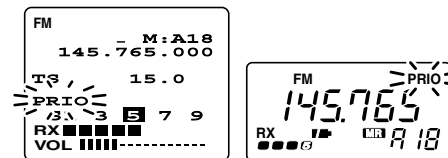

While pausing on the memory channel, “PRIO” flashes.

- ⑦ Push [V/M] while the display shows the VFO frequency to stop the watch.

◆ VFO scan watch

- ① Select the desired memory channel to be watched.
- ② Push [V/M] to select VFO mode.
- ③ Push [↔] for 2 sec. to start full scan, band scan or programmed scan. (p. 19)
- ④ Push [FUNC] + [(MODE)SET] momentarily to enter set mode.
 - Select a non-band scope screen in advance for color LCD.
- ⑤ Rotate [DIAL] to select “Priority” or “PRlo.”
 - “PRlo” disappears after 1 sec. and “oN” and “PR” appears when color LCD is OFF.
- ⑥ Push [↔] or rotate the tuning dial while pushing [FUNC] to select priority watch ON or priority watch ON with alert (BELL).
 - If the pocket beep function is activated, the receiver automatically selects the tone squelch function when the priority watch is selected.

Pause Scan : 10SEC Priority : OFF Beep Audio : VOLUME Light : AUTO A.Power OFF : OFF	Pause Scan : 10SEC Priority : ON Beep Audio : VOLUME Light : AUTO A.Power OFF : OFF	Pause Scan : 10SEC Priority : BELL Beep Audio : VOLUME Light : AUTO A.Power OFF : OFF
---	--	--



Priority watch set mode Priority watch is ON. Priority watch with alert is ON.

- ⑦ Push [(MODE)SET] to exit set mode and start the watch.
 - The receiver checks the memory channel frequency every 5 sec.
 - The watch resumes according to the selected scan resume condition. (p. 22)
 - If the priority watch with alert is ON, you can be alerted with beeps and a flashing “P.B” or “”.
 - If the direction finding screen is selected, the receiver automatically selects the simple screen when the priority watch starts.

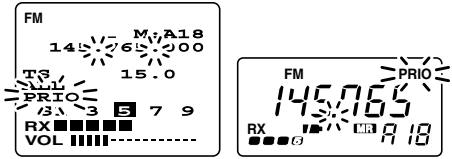

While pausing on the memory channel, “PRIO” flashes.

- ⑧ Push [V/M] while the display shows the VFO frequency to stop the watch.

■ Tone squelch operation

◇ Operation

The tone squelch opens only when receiving a signal containing a matching subaudible tone. You can silently wait for calls from group members using the same tone in an amateur band.

- ① Set the operating frequency in FM mode.
- ② Set the desired subaudible tone in set mode.
 - See the following section for programming.
- ③ Push [FUNC] + [(MODE)SET] momentarily to enter set mode.
 - Select a non-band scope screen in advance for color LCD.
- ④ Rotate [DIAL] until “Tone Squelch” or “tSqL” appears.
 - “tSqL” disappears after 1 sec. and “to” appears when color LCD is OFF.

Tone Squelch: OFF
Tone Freq. : 88.5
Duplex : OFF
Offset Freq.: 0.600
Scan Resume : 2SEC

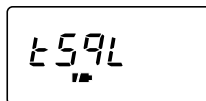

Tone function set mode

Tone Squelch: OFF
Tone Freq. : 88.5
Duplex : OFF
Offset Freq.: 0.600
Scan Resume : 2SEC

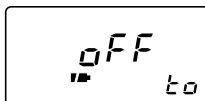

Tone squelch OFF

Tone Squelch: TSQL
Tone Freq. : 88.5
Duplex : OFF
Offset Freq.: 0.600
Scan Resume : 2SEC

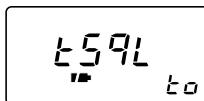

Tone squelch ON

- ⑤ Push [↔] or rotate the tuning dial while pushing [FUNC] to select “TSQL” (tone squelch).
- ⑥ Push [(MODE)SET] to exit set mode and start the tone squelch.
- ⑦ When the received signal includes a matching tone, the squelch opens and the signal can be heard.
 - When the received signal’s tone does not match, tone squelch does not open, however, the S-indicator shows signal strength.
 - To open the squelch manually, push and hold [SQL]. (default)
- ⑧ To cancel the tone squelch, repeat steps ③–⑥ as described above and select “OFF” in step ⑤.

◇ Setting subaudible tones for tone squelch operation

- ① Select VFO mode or desired memory channel to be programmed.
 - Each operating band and each memory channel have independent settings.
- ② Push [FUNC] + [(MODE)SET] momentarily to enter set mode.
 - Select a non-band scope screen in advance for color LCD.
- ③ Rotate [DIAL] until “Tone Freq.” or “tonE” appears.
 - “tonE” disappears after 1 sec. and “Ct” appears.
- ④ Push [↔] or rotate the tuning dial while pushing [FUNC] to select a subaudible tone.
- ⑤ Push [(MODE)SET] to exit set mode.

Tone Squelch: TSQ L Tone Freq. : 88.5 Duplex : OFF Offset Freq.: 0.600 Scan Resume : 2SEC	Tone Squelch: TSQ L Tone Freq. : 88.5 Duplex : OFF Offset Freq.: 0.600 Scan Resume : 2SEC	Tone Squelch: TSQ L Tone Freq. : 254.1 Duplex : OFF Offset Freq.: 0.600 Scan Resume : 2SEC
---	---	--



Tone frequency set mode

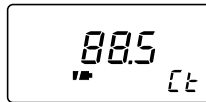

88.5 Hz (default)

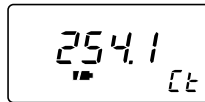

254.1 Hz tone

• Available subaudible tone frequencies (unit: Hz)

67.0	82.5	100.0	123.0	151.4	171.3	189.9	210.7	250.3
69.3	85.4	103.5	127.3	156.7	173.8	192.8	218.1	254.1
71.9	88.5	107.2	131.8	159.8	177.3	196.6	225.7	
74.4	91.5	110.9	136.5	162.2	179.9	199.5	229.1	
77.0	94.8	114.8	141.3	165.5	183.5	203.5	233.6	
79.7	97.4	118.8	146.2	167.9	186.2	206.5	241.8	

✓ CONVENIENT

Store subaudible tone frequencies and tone squelch ON/OFF settings in memories for easy recall.

/// The receiver has 50 tone frequencies and consequently their spacing is narrow. Therefore, some tone frequencies may receive interference from adjacent ones.

■ Pocket beep operation

This function uses subaudible tones for calling and can be used as a “common pager” to inform you that someone has called using the same tone in an amateur band while you were away from the receiver.

◆ Waiting for a call from a specific station

- ① Set the operating frequency in FM mode.
- ② Set the desired tone squelch tone in set mode.
 - See the previous page for programming information.
- ③ Turn the priority watch OFF when used. (p. 26)
 - The pocket beep cannot be used with the priority watch.
- ④ Push [FUNC] + [(MODE) SET] momentarily to enter set mode.
 - Select a non-band scope screen in advance for color LCD.

Tone Squelch: OFF Tone Freq. : 88.5 Duplex : OFF Offset Freq.: 0.600 Scan Resume : 2SEC



Tone function set mode

Tone Squelch: OFF Tone Freq. : 88.5 Duplex : OFF Offset Freq.: 0.600 Scan Resume : 2SEC



Tone function OFF

Tone Squelch: P BEEP Tone Freq. : 88.5 Duplex : OFF Offset Freq.: 0.600 Scan Resume : 2SEC
--

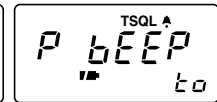

Pocket beep ON

8 SUBAUDIBLE TONE OPERATION

- ⑤ Rotate [DIAL] until “Tone Squelch” or “tSql” appears.
 - “tSql” disappears after 1 sec. and “to” appears when color LCD is OFF.
- ⑥ Push [↔] or rotate the tuning dial while pushing [FUNC] to select “P BEEP” (pocket beep).
- ⑦ Push [(MODE)SET] to exit set mode and start the pocket beep.
 - “P.B” or “TSQL 📢” appears in the function display.
- ⑧ When a signal with the correct tone is received, the receiver emits beep tones for 30 sec. and flashes “P.B” or “📢”.

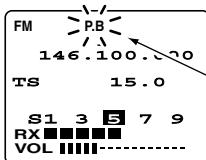

flashes when correct tone is received.

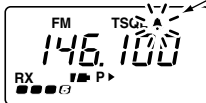

- ⑨ Push [SQL] to stop the beeps and flashing.
 - Tone squelch is automatically selected.

■ Tone scan

The receiver can detect the subaudible tone frequency in a received signal. By monitoring a signal that is being transmitted on a frequency, you can check the tone frequency required to access the repeater, or to open the tone squelch.

- ① Set the desired frequency or memory channel to be checked for a tone frequency.
- ② Select FM mode with [MODE].
- ③ Push [FUNC] + [↔] for 2 sec. to start the tone scan.
 - To change the scanning direction, rotate [DIAL].
- ④ When the tone frequency is detected, the set mode contents are programmed with the tone frequency.
 - The tone scan pauses when a tone frequency is detected.
 - The detected tone frequency is used for the tone squelch frequency.
 - “Ct” appears during tone scan.
- ⑤ Push [↔] to stop the scan.

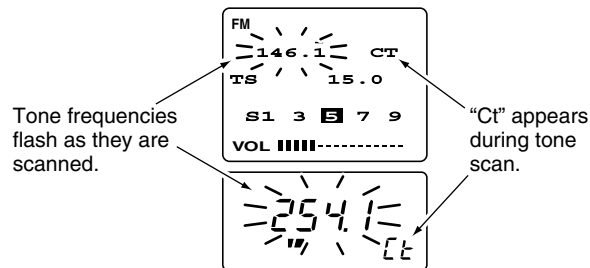

Duplex communication uses 2 different frequencies for transmitting and receiving. Generally, duplex is used in communication through a repeater, some utility communications, etc.

During duplex operation, the transmit station frequency is shifted from the receive station frequency by the offset frequency. Repeater information (offset frequency and shift direction) can be programmed into memory channels. (p. 14)

/// This function is not available in the broadcast band (0.495 MHz – 1.620 MHz) except for U.S.A. and Canada versions.

- ① Set the receive station frequency (repeater output frequency).
- ② Set the shift direction and offset of the transmit station frequency as described below.
- ③ Push and hold [SQL] to monitor the transmit station frequency (repeater input frequency) directly.

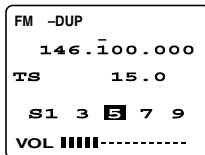

◆ Duplex shift direction

- ① Push [FUNC] + [(MODE) SET] momentarily to enter set mode.
 - Select a non-band scope screen in advance for color LCD.
- ② Rotate [DIAL] until “Duplex” or “dUP” appears.
 - “dUP” disappears after 1 sec. and “dP” appears when color LCD is OFF.
- ③ Push [↔] or rotate the tuning dial while pushing [FUNC] to select “-DUP” or “(+)-DUP.”
 - “-DUP” or “(+)-DUP” indicates the transmit station frequency for minus shift or plus shift, respectively.
- ④ Push [(MODE) SET] to exit set mode.

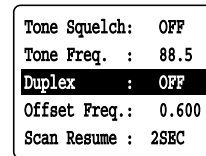

Duplex direction set mode

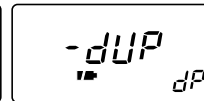
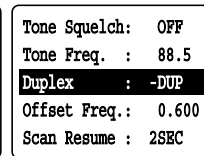

Minus shift

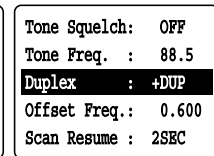

Plus shift

9 DUPLEX OPERATION

◆ Offset frequency

During duplex operation, the transmit station frequency is shifted from the receive station frequency by an amount determined by the offset frequency.

- ① Select VFO mode or desired memory channel to be programmed.
- ② Push [FUNC] + [(MODE) SET] momentarily to enter set mode.
 - Select a non-band scope screen in advance for color LCD.
- ③ Rotate [DIAL] until “Offset Freq.” or “oFFSEt” appears.
 - “oFFSEt” disappears after 1 sec. and “oW” appears when the color LCD is OFF.

Tone Squelch: OFF
Tone Freq. : 88.5
Duplex : OFF
Offset Freq.: 0.600
Scan Resume : 2SEC

Tone Squelch: OFF
Tone Freq. : 88.5
Duplex : OFF
Offset Freq.: 0.600
Scan Resume : 2SEC

Tone Squelch: OFF
Tone Freq. : 88.5
Duplex : OFF
Offset Freq.: 7.600
Scan Resume : 2SEC

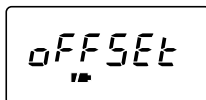

Offset frequency set mode

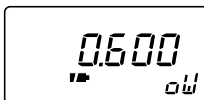

0.6 MHz (600 kHz) offset

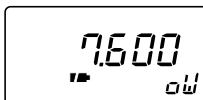

7.6 MHz offset

- ④ Push [↔] or rotate the tuning dial while pushing [FUNC] to set the desired offset.
 - The offset frequency changes according to the selected tuning step. (p. 8)
- ⑤ Push [(MODE) SET] to exit set mode.

BAND SCOPE 10

The band scope function allows you to visually check a specified frequency range. Sweep range can be selected from ± 5 kHz through ± 500 kHz.

- Receive audio is muted while monitoring the band scope.
- Push [SQL] to cancel sweeping and receive the audio.

- Push [FUNC] + [\uparrow] for 2 sec. to turn the color LCD ON.
- Push [FUNC] + [\uparrow] one or more times to select the band scope screen.
- Set the desired frequency as band scope center frequency.
- Push [FUNC] + [V/M] momentarily to select the sweep range, if desired.
 - 5, 10, 20, 100 and 500 kHz sweep ranges are available.

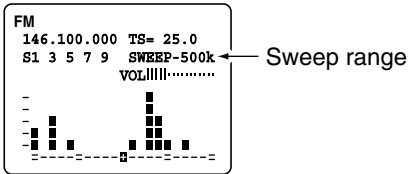

- Push [FUNC] + [V/M] momentarily to start a sweep once or push them for 2 sec. to start sweeping continuously.
 - Signal conditions (strengths) appear starting from the center of the range.
 - Push [SQL] to cancel sweeping.

- Rotate [DIAL] to set the highlighted cursor to the desired waveform and set the frequency of the signal.
 - Start sweeping to set the selected frequency to the center frequency.

11 TV OPERATION

■ TV operation

The receiver can receive TV (NTSC or PAL depending on version). TV channels are preset depending on versions.

The received video and audio can be output from [A/V OUT] if desired.

◇ TV channel receiving

- ① Push [FUNC] + [↕] for 2 sec. to turn the color LCD ON, if desired.
 - Only the audio part of the TV contents can be received.
- ② Push [←→] one or more times to select the TV channel band.
 - "tV" and channel number appear in the sub LCD.
 - The squelch is automatically opened. Push [SQL] to toggle between squelch open and audio mute conditions.
- ③ Rotate [DIAL] to select the desired channel.
 - Rotate [DIAL] while pushing [FUNC] to select the skip channel.



◇ Skip channel setting

Unwanted channels can be skipped for rapid selection, etc.

- ① Rotate [DIAL] to select the channel to be skipped.
 - To clear the skip setting, rotate [DIAL] while pushing [FUNC] to select a skip channel.
- ② While pushing [FUNC], push [(V/M) SKIP] for 2 sec. to toggle the condition between non-skip and skip channel.
 - No indication : channel will not be skipped.
 - "▶" appears : channel skipped during selection.

/// To select a skip TV channel temporarily, rotate [DIAL] while pushing [FUNC].

◇ Automatic TV channel programming

TV channels can be programmed automatically.

- ① Push [FUNC] + [←→] for 2 sec. to start TV channel programming.
- ② The programming will automatically stop after scanning all channels.

◇ TV frequency (AM TV) receiving

You can set the TV frequency instead of channel selection, if desired.

- ① Push [FUNC] + [↑] for 2 sec. to turn the color LCD ON, if desired.
 - The audio part of the TV contents can be received when the color LCD is turned OFF.
- ② Push [↔] one or more times to select the band above 30 MHz.
 - TV receiving does not function for less than 30 MHz.
- ③ Push [FUNC] + [↑] one or more times to select the TV screen.
 - “TV” and frequency appear in the sub LCD.
 - The squelch is automatically opened. Push [SQL] to toggle between squelch open and audio mute conditions.
- ④ Rotate [DIAL] to set the desired frequency.
 - Push [↔] one or more times to select the band.
 - Rotate [DIAL] while pushing [FUNC] for dial select step. (p. 39)



◇ TV frequency (AM TV) memory channel

The receiver has 10 memory channels for storage of often-used TV (AM TV) frequencies.

- ① Set the desired frequency with [DIAL].
 - Push [↔] one or more times to select the band.
 - Rotate [DIAL] while pushing [FUNC] for dial select step. (p. 39)
- ② Push [V/M] for 1 sec. to indicate memory channels.
 - Do not hold [V/M] for more than 2 sec., otherwise the previously selected memory channel will be overwritten.
- ③ Rotate [DIAL] to select the desired channel.
- ④ Push [V/M] for 1 sec. to program.
 - Keep pushing for 2 sec. or more to automatically select the next memory channel, if desired.

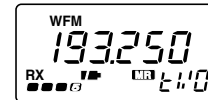

Memory programming after selection, memory transferring or memory clearing can be used as same manner of regular memory channels. (pgs. 15, 16)

11 TV OPERATION

■ ATV operation

The IC-R3 ATV-type can receive an amateur TV (FM TV) within 900–1300 and 2250–2450.095 MHz. The received video and audio can be output from [A/V OUT] if desired. (p. 5)

- 1 Push [FUNC] + [↕] for 2 sec. to turn the color LCD ON, if desired.
 - Only the audio part of the TV contents can be received.
- 2 Push [↔] one or more times to select the 1200 or 2400 MHz bands.
- 3 Push [FUNC] + [↕] one or more times to select the amateur TV screen.
 - "FtV" and frequency appear in the sub LCD.
 - The squelch is automatically opened. Push [SQL] to toggle between squelch open and audio mute conditions.
- 4 Rotate [DIAL] to set the desired frequency.



▨ The video display mode can be selected as positive and negative depending on the received signal. Push [MODE] to toggle the display mode, if desired.

◇ ATV memory channel

The receiver has 50 memory channels for storage of often-used ATV (Amateur TV) frequencies.

- 1 Set the desired frequency with [DIAL].
 - Push [↔] to select the 1200 or 2400 MHz band.
 - Rotate [DIAL] while pushing [FUNC] for dial select step. (p. 39)
- 2 Push [V/M] for 1 sec. to indicate memory channels.
 - Do not hold [V/M] for more than 2 sec., otherwise the previously selected memory channel will be overwritten.
- 3 Rotate [DIAL] to select the desired channel.
- 4 Push [V/M] for 1 sec. to program.
 - Keep pushing for 2 sec. or more to automatically select the next memory channel, if desired.

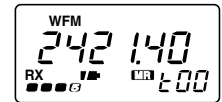

▨ Memory programming after selection, memory transferring or memory clearing can be used as same manner of regular memory channels. (pgs. 15, 16)

◇ Sub carrier adjustment

- 1 Push [FUNC] + [↔] for 2 sec. to enter sub carrier set mode.
- 2 Push [↔] or rotate the tuning dial while pushing [FUNC] to adjust sub carrier for better audio receiving.
- 3 Push [↔] to exit sub carrier set mode.

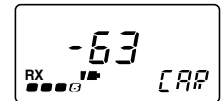

DIRECTION FINDING 12

The direction finding function allows you to check a variation of the signal level continuously.

Using a commercially available directional antenna, you can determine the direction of the signal source. Using 2 receivers with the directional antennas, you can pinpoint the signal source.

- ① Push [FUNC] + [↕] for 2 sec. to turn the color LCD ON.
- ② Push [FUNC] + [↕] one or more times to select the direction finding screen.
- ③ Set the desired frequency.
 - The color LCD shows the variation of the signal level.
 - If the strong signal is received on 1149.995 MHz or below, use the attenuator function. (p. 9)

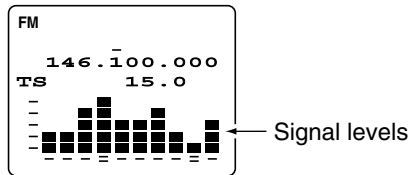

- ④ Turn around the directional antenna for maximum receive level.
- ⑤ The direction (or opposite) of the maximum receive level may indicate the signal source direction.

• Direction finding function example

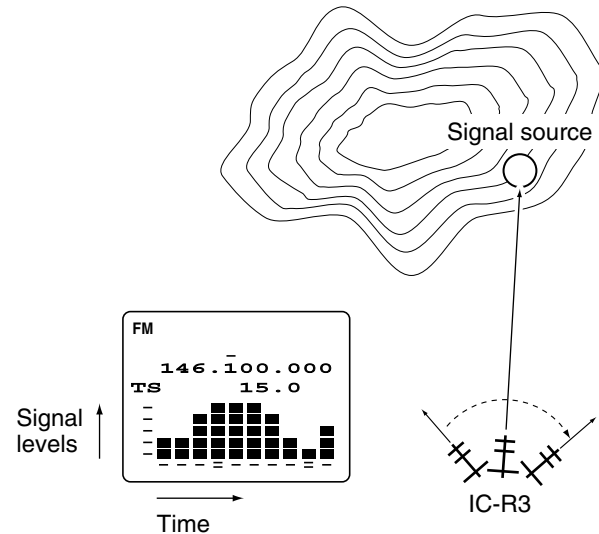

/// The direction finding function is a supplemental aid for finding a signal source only. It is not designed for use as a compass.

13 OTHER FUNCTIONS

■ Set mode

Set mode is used for programming infrequently changed values or conditions of functions.

◇ Set mode items

Tone Squelch	<i>tS9L</i>	Tone squelch (p. 28)	A.Power OFF	<i>AP OFF</i>	Auto power OFF (p. 40)
Tone Freq.	<i>tonE</i>	Tone squelch tone frequency (p. 28)	Power Save	<i>P SAVE</i>	Power save (p. 41)
Ⓜ Duplex	<i>dup</i>	Duplex direction (p. 31)	Monitor	<i>moni</i>	Monitor switch action (p. 41)
Ⓜ Offset Freq.	<i>offset</i>	Offset frequency (p. 32)	Dial Speedup	<i>SPEED</i>	Dial speed (p. 42)
Scan Resume	<i>RESUME</i>	Scan resume time (p. 23)	Key Lock	<i>Lock</i>	Lock function effect (p. 42)
Pause Scan	<i>PAUSE</i>	Scan pause time (p. 22)	Display	<i>dISP</i>	Display mode (p. 43)
Priority	<i>PP10</i>	Priority watch (p. 26)	Ⓜ Contrast	Ⓜ <i>ContPA</i>	Color LCD contrast (p. 43)
Beep Audio	<i>beep</i>	Confirmation beep (p. 40)	Ⓜ Bright	Ⓜ <i>brIGHt</i>	Color LCD brightness (p. 44)
Light	<i>LIGHt</i>	Backlighting (p. 13)	Ⓜ Back Color	(Color LCD only)	Color LCD background color (p. 44)

Ⓜ: Appears when the color LCD is ON.

Ⓜ: Appears when receiving TV.

Ⓜ: Does not appear within the broadcast band (0.495–1.620 MHz) except for U.S.A. and Canada versions

■ Dial select step

This receiver has a 1 MHz tuning step for quick frequency setting. This dial select step can be set to 100 kHz, 1 MHz or 10 MHz steps, as desired.

The selected dial select step is always displayed in the simple, multi-function and direction finding screen in the color LCD.



This function is not available to the broadcast band (0.495–1.620 MHz) except for U.S.A. and Canada versions.

◆ Setting dial select step

- ① Select VFO mode with [V/M].
- ② Push [FUNC] + [↔] momentarily to enter dial select step setting condition.
 - “8” appears to the selected dial select step.
- ③ While continuously pushing [FUNC], push [↔] to select the desired dial select step.
 - 100 kHz, 1 MHz and 10 MHz steps are available.
- ④ Release [FUNC] to exit the condition.

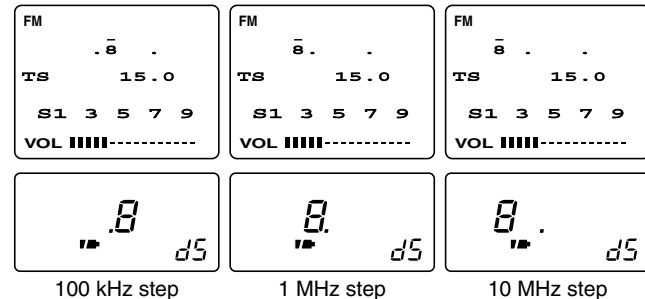

13 OTHER FUNCTIONS

■ Beep tones

The volume level for confirmation beep tones, which sound each time a switch is pushed, can be adjusted, as desired.

When "VOLUME" is selected, the beep tone volume level is linked with the receive volume level.

- ① Push [FUNC] + [(MODE) SET] momentarily to enter set mode.
 - Select a non-band scope screen in advance for color LCD.
- ② Rotate [DIAL] until "Beep Audio" or "bBEEP" appears.
 - "bBEEP" disappears after 1 sec. and "bE" appears when color LCD is OFF.
- ③ Push [↔] or rotate the tuning dial while pushing [FUNC] to set the volume level.
- ④ Push [(MODE) SET] to exit set mode.

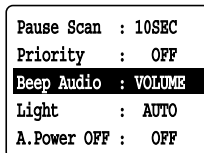

Pause Scan : 10SEC
Priority : OFF
Beep Audio : VOLUME
Light : AUTO
A.Power OFF : OFF

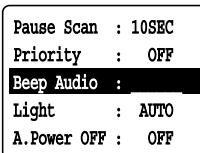

Pause Scan : 10SEC
Priority : OFF
Beep Audio : bE
Light : AUTO
A.Power OFF : OFF

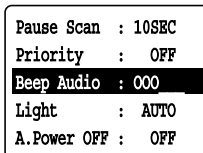

Pause Scan : 10SEC
Priority : OFF
Beep Audio : 000
Light : AUTO
A.Power OFF : OFF

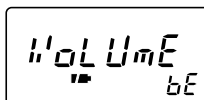

VOLUME
bE

Beep tone is turned ON and linked with the volume level.

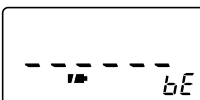

bE

Beep tone is turned OFF (minimum).

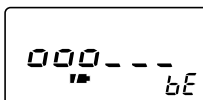

000-----
bE

Beep tone is fixed to the set level.

■ Auto power-off function

The receiver can be set to automatically turn OFF after a specified period with beep in which no switch is pushed.

120 min., 90 min., 60 min., 30 min. and OFF can be specified. The specified period is retained even when the receiver is turned OFF by the auto power-off function. To cancel the function, select "OFF" in step ③ below.

- ① Push [FUNC] + [(MODE) SET] momentarily to enter set mode.
 - Select a non-band scope screen in advance for color LCD.
- ② Rotate [DIAL] until "A.Power OFF" or "AP oFF" appears.
 - "AP oFF" disappears after 1 sec. and "Ao" appears when color LCD is OFF.
- ③ Push [↔] or rotate the tuning dial while pushing [FUNC] to select the desired time or to turn the function OFF.
- ④ Push [(MODE) SET] to exit set mode.

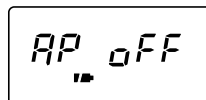

AP oFF
Ao

Auto power off set mode

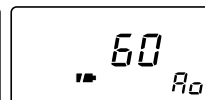

60
Ao

60 min. auto power-off

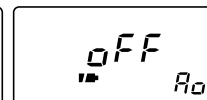



oFF
Ao

Auto power-off is turned OFF.

■ Power saver

The power saver function reduces the current drain to conserve battery power.



- ① Push [FUNC] + [(MODE)SET] momentarily to enter set mode.
 - Select a non-band scope screen in advance for color LCD.
- ② Rotate [DIAL] until “Power Save” or “P SAVE” appears.
 - “P SAVE” disappears after 1 sec. and “PS” appears when color LCD is OFF.
- ③ Push [↔] or rotate the tuning dial while pushing [FUNC] to turn the power saver ON (AUTO) or OFF.
- ④ Push [(MODE)SET] to exit set mode.

Power Save : AUTO Monitor : PUSH Dial Speedup: ON Key Lock : NORMAL Display : AUTO	Power Save : AUTO Monitor : PUSH Dial Speedup: ON Key Lock : NORMAL Display : AUTO	Power Save : OFF Monitor : PUSH Dial Speedup: ON Key Lock : NORMAL Display : AUTO
		
Power save set mode	Power saver ON (AUTO)	Power saver OFF

■ Monitor switch action

The monitor switch can be set as a ‘sticky’ switch. When set to the sticky condition, each push of [SQL] toggles the monitor function on and off.

- ① Push [FUNC] + [(MODE)SET] momentarily to enter set mode.
 - Select a non-band scope screen in advance for color LCD.
- ② Rotate [DIAL] until “Monitor” or “moni” appears.
 - “moni” disappears after 1 sec. and “mo” appears when color LCD is OFF.
- ③ Push [↔] or rotate the tuning dial while pushing [FUNC] to set the monitor switch to sticky (HOLD) or normal (PUSH).
- ④ Push [(MODE)SET] to exit set mode.

Power Save : AUTO Monitor : PUSH Dial Speedup: ON Key Lock : NORMAL Display : AUTO	Power Save : AUTO Monitor : HOLD Dial Speedup: ON Key Lock : NORMAL Display : AUTO	Power Save : AUTO Monitor : PUSH Dial Speedup: ON Key Lock : NORMAL Display : AUTO
		
Monitor switch function set mode	‘Sticky’ action	‘Normal’ action

13 OTHER FUNCTIONS

■ Dial speed acceleration

The dial speed acceleration automatically speeds up the tuning dial speed when rotating the [DIAL] rapidly.

- 1 Push [FUNC] + [(MODE) SET] momentarily to enter set mode.
 - Select a non-band scope screen in advance for color LCD.
- 2 Rotate [DIAL] until “Dial Speedup” or “SPEED” appears.
 - “SPEED” disappears after 1 sec. and “SP” appears.
- 3 Push [↔] or rotate the tuning dial while pushing [FUNC] to set the dial speed acceleration ON or OFF.
- 4 Push [(MODE) SET] to exit set mode.

Power Save : AUTO
Monitor : PUSH
Dial Speedup: ON
Key Lock : NORMAL
Display : AUTO

Power Save : AUTO
Monitor : PUSH
Dial Speedup: ON
Key Lock : NORMAL
Display : AUTO

Power Save : AUTO
Monitor : PUSH
Dial Speedup: OFF
Key Lock : NORMAL
Display : AUTO

Dial speed acceleration set mode

Dial speed acceleration ON

Dial speed acceleration OFF

■ Lock function effect

The lock function prevents accidental frequency changes and accidental function access.

While the lock function is ON, [POWER], [VOL (↕)] and [SQL] can still be accessed. Accessible switches can be set to 1 of 4 groups in set mode.

- 1 Push [FUNC] + [(MODE) SET] momentarily to enter set mode.
 - Select a non-band scope screen in advance for color LCD.
- 2 Rotate [DIAL] until “Key Lock” or “LoCk” appears.
 - “LoCk” disappears after 1 sec. and “Lk” appears.
- 3 Push [↔] or rotate the tuning dial while pushing [FUNC] to select the accessible switches.
 - “NORMAL” : [POWER], [VOL] and [SQL] are accessible.
 - “NO SQL” : [POWER] and [SQL] are accessible.
 - “NO VOL” : [POWER] and [VOL] are accessible.
 - “ALL” : [POWER] is accessible.
- 4 Push [(MODE) SET] to exit set mode.

Lock function effect set mode

[POWER], [VOL] and [SQL] are accessible.

[POWER] and [SQL] are accessible.

■ Display mode selection

The color LCD can be automatically turned ON when using with the external DC power (CP-18A/E or commercially available DC power supply; 5.5–6.3 V DC with more than 4 A capacity).

- ① Push [FUNC] + [(MODE)SET] momentarily to enter set mode.
 - Select a non-band scope screen in advance for color LCD.
- ② Rotate [DIAL] until “Display” or “dISP” appears.
 - “dISP” disappears after 1 sec. and “d” appears.
- ③ Push [↔] or rotate the tuning dial while pushing [FUNC] to set the color LCD mode to automatic (AUTO) or manual.
 - The color LCD will be turned OFF after setting.
- ④ Push [(MODE)SET] to exit set mode.

Key Lock	: NORMAL
Display	: AUTO
Contrast	: 50%
Bright	: 50%
Back Color	: 4

Display mode set mode

Key Lock	: NORMAL
Display	: MANUAL
Contrast	: 50%
Bright	: 50%
Back Color	: 4

Manual selection

Key Lock	: NORMAL
Display	: AUTO
Contrast	: 50%
Bright	: 50%
Back Color	: 4

Automatic selection

■ Display contrast

This item adjusts the contrast of the color LCD from 0 % to 100 % in 32 steps.

- ① Push [FUNC] + [↑] for 2 sec. to turn the color LCD ON.
- ② Push [FUNC] + [(MODE)SET] momentarily to enter set mode.
 - Select a non-band scope screen in advance.
- ③ Rotate [DIAL] until “Contrast” or “ContRA” appears.
 - “ContRA” disappears after 1 sec. and “co” appears.
- ④ Push [↔] or rotate the tuning dial while pushing [FUNC] to adjust the contrast of the color LCD.
- ⑤ Push [(MODE)SET] to exit set mode.

Key Lock	: NORMAL
Display	: AUTO
Contrast	: 50%
Bright	: 50%
Back Color	: 4

Display contrast set mode

Key Lock	: NORMAL
Display	: AUTO
Contrast	: 50%
Bright	: 50%
Back Color	: 4

50% (default)

Key Lock	: NORMAL
Display	: AUTO
Contrast	: 25%
Bright	: 50%
Back Color	: 4

25%

13 OTHER FUNCTIONS

■ Display brightness

This item adjusts the brightness of the color LCD from 0 % to 100 % in 32 steps.

- ① Push [FUNC] + [↑] for 2 sec. to turn the color LCD ON.
- ② Push [FUNC] + [(MODE) SET] momentarily to enter set mode.
 - Select a non-band scope screen in advance.
- ③ Rotate [DIAL] until “Bright” appears.
 - “bRIGHT” disappears after 1 sec. and “bR” appears.
- ④ Push [←→] or rotate the tuning dial while pushing [FUNC] to adjust the brightness of the color LCD.
- ⑤ Push [(MODE) SET] to exit set mode.

Key Lock : NORMAL	Key Lock : NORMAL	Key Lock : NORMAL
Display : AUTO	Display : AUTO	Display : AUTO
Contrast : 50%	Contrast : 50%	Contrast : 50%
Bright : 50%	Bright : 50%	Bright : 25%
Back Color : 4	Back Color : 4	Back Color : 4

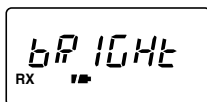

Display brightness
set mode

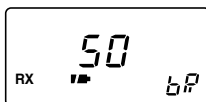

50% (default)

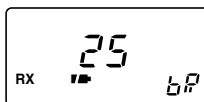

25%

■ Display background color

This item selects the background color of the color LCD from 8 colors.

- ① Push [FUNC] + [↑] for 2 sec. to turn the color LCD ON.
- ② Push [FUNC] + [(MODE) SET] momentarily to enter set mode.
 - Select a non-band scope screen in advance.
- ③ Rotate [DIAL] until “Back Color” appears.
- ④ Push [←→] or rotate the tuning dial while pushing [FUNC] to select the background color.
 - 0 black 4 blue
 - 1 pink 5 purple
 - 2 green 6 lime
 - 3 orange 7 white
- ⑤ Push [(MODE) SET] to exit set mode.

Key Lock : NORMAL	Key Lock : NORMAL
Display : AUTO	Display : AUTO
Contrast : 50%	Contrast : 50%
Bright : 50%	Bright : 50%
Back Color : 4	Back Color : 1

4 (default)

1 (black)

■ Cloning function

The IC-R3 has receiver-to-receiver data cloning capability. This function is useful when you want to copy all of the programmed contents from one IC-R3 to another. An optional OPC-474 CLONING CABLE is required.

The optional CS-R3 CLONING SOFTWARE and the optional OPC-478 CLONING CABLE are available to clone and edit contents with a PC (for Microsoft® Windows® 95 and 98).

- ① While pushing [MODE] and ☺ [UP], push [POWER] for 2 sec. to enter cloning mode.
 - “CLonE” appears.
- ② Connect an optional OPC-474 between both [SP] jacks.
- ③ Push [SQL] on the “master” receiver (receiver-to-receiver cloning only).
 - “oUt” appears and the signal indicator shows that cloning is taking place.
- ④ Push [POWER] for 2 sec. to turn power OFF.

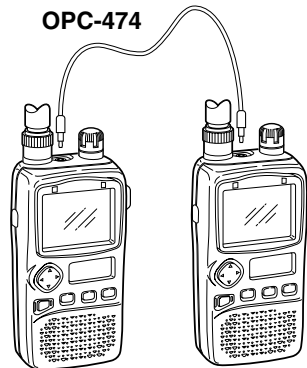

Microsoft® and Windows® are registered trademarks of Microsoft Corporation in the U.S.A. and other countries.

■ Partial reset

If you want to initialize the operating conditions (VFO frequency, VFO settings, set mode contents) without clearing the memory contents, a partial resetting function is available for the receiver.

- ➔ While pushing [FUNC] and [V/M], turn power ON to partially reset the receiver.

■ Total reset

Reset the CPU before operating the receiver for the first time, or when the internal CPU malfunctions.

- ➔ While pushing [FUNC], [V/M] and [MODE], turn power ON to reset the CPU.
 - “CLEAR” appears in the sub LCD when resetting the CPU.

CAUTION: Resetting the CPU returns all programmed contents to their default settings.

14 BATTERY CHARGING

■ Battery cautions

NEVER incinerate used battery packs. Internal battery gas may cause an explosion.

NEVER immerse the battery pack in water. If the battery pack becomes wet, be sure to wipe it dry **BEFORE** attaching it to the receiver.

NEVER short terminals of the battery pack. Also, current may flow into nearby metal objects so be careful when placing battery packs in handbags, etc.

If your battery pack seems to have no capacity even after being charged, completely discharge it by leaving the power ON overnight. Then, fully charge the battery pack again. If the battery pack still does not retain a charge (or very little), a new battery pack must be purchased.

Use Icom battery packs, chargers or cables only. The use of non-Icom products may impair receiver performance and invalidate the warranty.

■ Battery charging

Prior to using the receiver for the first time, the battery pack must be fully charged for optimum life and operation.

CAUTION: To avoid damage to the receiver, turn it OFF while charging.

- Recommended temperature range for charging: 0°C to +35°C; +32°F to +95°F
- Use the wall charger (BC-153A/D*) or optional desktop charger (BC-135 for rapid charging) only. **NEVER** use another manufacturer's charger.
* Not supplied with some versions.
- An optional cable CP-18A/E (for 12 V cigarette lighter socket) can be used instead of the AC adapters of the above chargers.

CAUTION: **BE SURE** to remove the CP-18A/E when charging is finished, because, a slight current still follows in the CP-18A/E and the vehicle's battery will become exhausted.

◆ Battery pack installation

- ① Remove the battery cover from the receiver.
- ② Remove the supplied battery spacer for alkaline battery use.
- ③ Install the Li-Ion battery pack (BP-206).
 - Be sure to observe the correct direction.
 - Charge Li-Ion battery pack before use.

• Battery pack installation

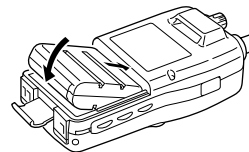

• Battery pack removal

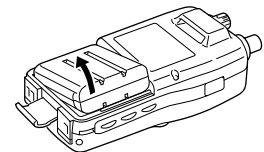

◆ Regular charging

- ① Attach the battery pack to the receiver.
- ② Connect the AC adapter (BC-153A/D*) or optional cable (CP-18A/E) as shown below.

*Not supplied with some versions.

- ③ Remove any cables from the [DC 6V] jack.

•Charging periods: 15 hours (w/BP-206)

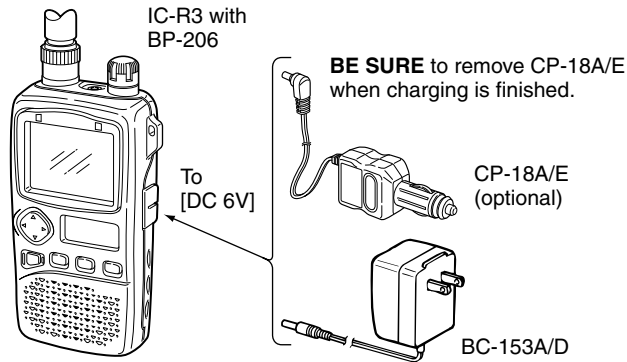

◆ CP-18A/E fuse replacement

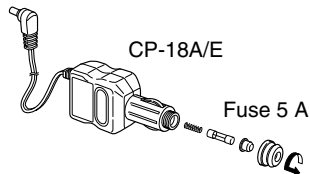

◆ Rapid charging with the BC-135

The optional BC-135 provides rapid charging of battery packs.

•Charging periods: 2.5 hours (w/BP-206)

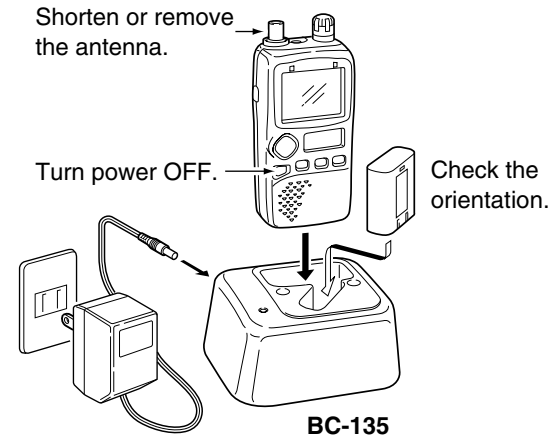



CAUTION: Shorten or remove the telescoping antenna before charging to prevent the receiver from overturning.

If the charge indicator flashes orange, there may be a problem with the battery pack (or charger). Re-insert the battery pack or contact your dealer.

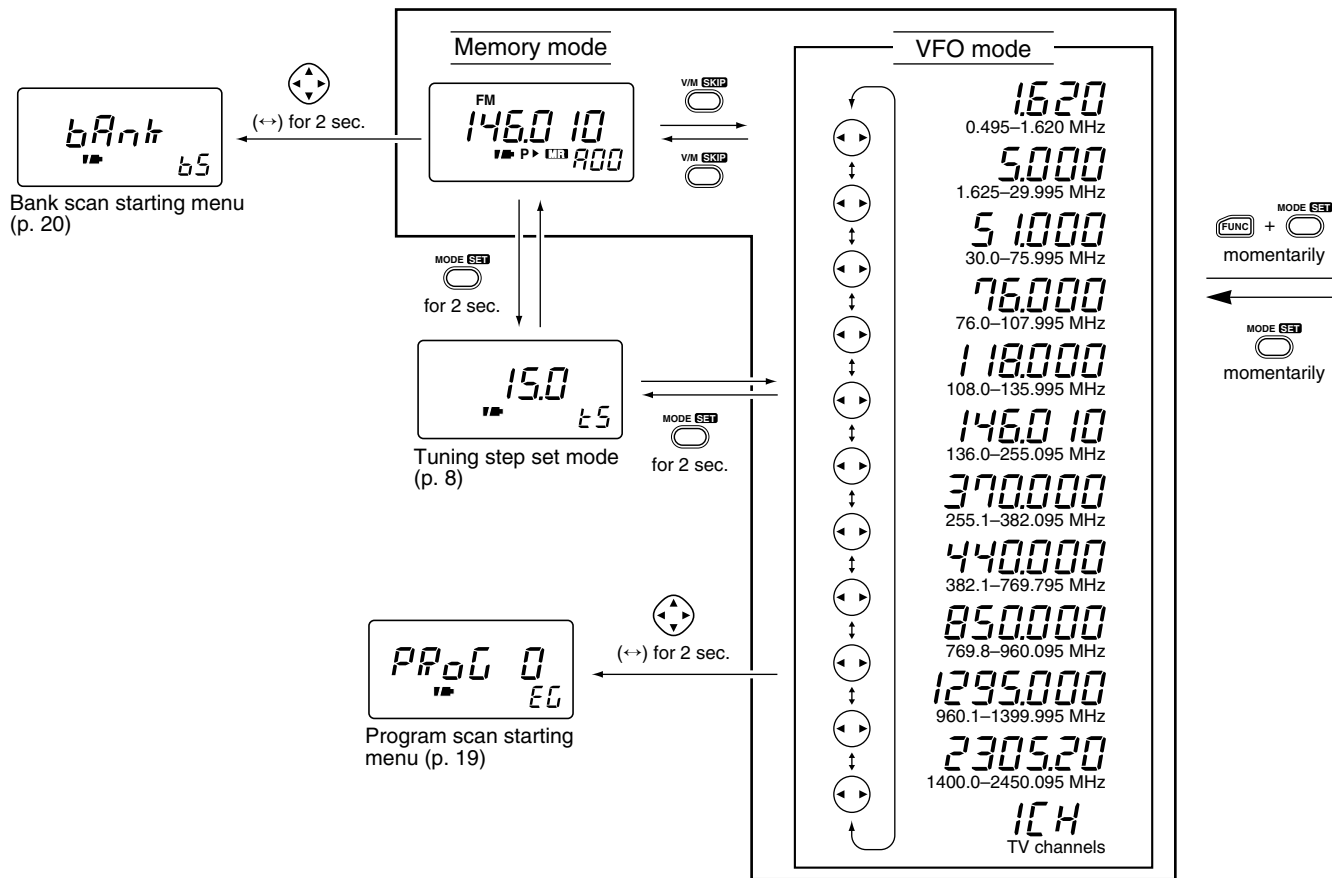

15 OPERATION FLOW CHART

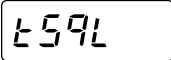

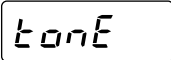
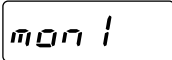
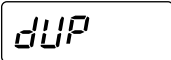
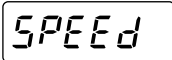
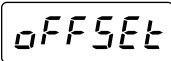
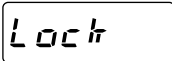
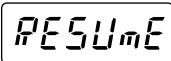
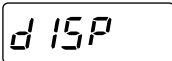
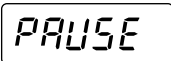
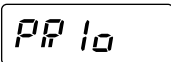
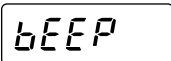
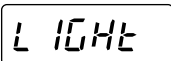
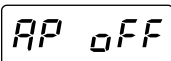
Set mode

	Tone squelch (p. 28)		Power save (p. 41)														
	Tone squelch tone frequency (p. 28)		Monitor switch action (p. 41)														
	B Duplex direction (p. 31)		Dial speed (p. 42)														
	B Offset frequency (p. 32)		Lock function effect (p. 42)														
	Scan resume time (p. 23)		Color LCD function (p. 43)														
	Scan pause time (p. 22)	<table border="0"> <tbody> <tr> <td>Key Lock</td> <td>: NORMAL</td> <td>Color LCD contrast (p. 43)</td> </tr> <tr> <td>Display</td> <td>: AUTO</td> <td>Color LCD brightness (p. 44)</td> </tr> <tr> <td>Contrast</td> <td>: 50%</td> <td></td> </tr> <tr> <td>Bright</td> <td>: 50%</td> <td></td> </tr> <tr> <td>Back Color</td> <td>: 4</td> <td>L Color LCD background color (p. 44)</td> </tr> </tbody> </table>	Key Lock	: NORMAL	Color LCD contrast (p. 43)	Display	: AUTO	Color LCD brightness (p. 44)	Contrast	: 50%		Bright	: 50%		Back Color	: 4	L Color LCD background color (p. 44)
Key Lock	: NORMAL		Color LCD contrast (p. 43)														
Display	: AUTO	Color LCD brightness (p. 44)															
Contrast	: 50%																
Bright	: 50%																
Back Color	: 4	L Color LCD background color (p. 44)															
	Priority watch (p. 26)																
	Confirmation beep (p. 40)																
	Backlighting (p. 13)																
	Auto power OFF (p. 40)																

- B**: Does not appear within the broadcast band (0.495 – 1.620 MHz).
- L**: Appears when the color LCD is ON.

-  Displays for set modes show the default settings.
-  Push [↔] or rotate the tuning dial while pushing [FUNC] to change the set mode condition.

16 TV FREQUENCY TABLE

The following tables show the channels versus video and audio frequencies depending on each version.

■ U.S.A. channels

CH	Video	Audio	CH	Video	Audio
2	55.25	59.75	26	543.25	547.75
3	61.25	65.75	27	549.25	553.75
4	67.25	71.75	28	555.25	559.75
5	77.25	81.75	29	561.25	565.75
6	83.25	87.75	30	567.25	571.75
7	175.25	179.75	31	573.25	577.75
8	181.25	185.75	32	579.25	583.75
9	187.25	191.75	33	585.25	589.75
10	193.25	197.75	34	591.25	595.75
11	199.25	203.75	35	597.25	601.75
12	205.25	209.75	36	603.25	607.75
13	211.25	215.75	37	609.25	613.75
14	471.25	475.75	38	615.25	619.75
15	477.25	481.75	39	621.25	625.75
16	483.25	487.75	40	627.25	631.75
17	489.25	493.75	41	633.25	637.75
18	495.25	499.75	42	639.25	643.75
19	501.25	505.75	43	645.25	649.75
20	507.25	511.75	44	651.25	655.75
21	513.25	517.75	45	657.25	661.75
22	519.25	523.75	46	663.25	667.75
23	525.25	529.75	47	669.25	673.75
24	531.25	535.75	48	675.25	679.75
25	537.25	541.75	49	681.25	685.75

■ CCIR channels

CH	Video	Audio	CH	Video	Audio
1	41.25	46.75	31	551.25	556.75
2	48.25	53.75	32	559.25	564.75
3	55.25	60.75	33	567.25	572.75
4	62.25	67.75	34	575.25	580.75
5	175.25	180.75	35	583.25	588.75
6	182.25	187.75	36	591.25	596.75
7	189.25	194.75	37	599.25	604.75
8	196.25	201.75	38	607.25	612.75
9	203.25	208.75	39	615.25	620.75
10	210.25	215.75	40	623.25	628.75
11	217.25	222.75	41	631.25	636.75
12	224.25	229.75	42	639.25	644.75
21	471.25	476.75	43	647.25	652.75
22	479.25	484.75	44	655.25	660.75
23	487.25	492.75	45	663.25	668.75
24	495.25	500.75	46	671.25	676.75
25	503.25	508.75	47	679.25	684.75
26	511.25	516.75	48	687.25	692.75
27	519.25	524.75	49	695.25	700.75
28	527.25	532.75	50	703.25	708.75
29	535.25	540.75	51	711.25	716.75
30	543.25	548.75	52	719.25	724.75

■ Australian channels

CH	Video	Audio
53	727.25	732.75
54	735.25	740.75
55	743.25	748.75
56	751.25	756.75
57	759.25	764.75
58	767.25	772.75
59	775.25	780.75
60	783.25	788.75
61	791.25	796.75
62	799.25	804.75
63	807.25	812.75
64	815.25	820.75
65	823.25	828.75
66	831.25	836.75
67	839.25	844.75
68	847.25	852.75
69	855.25	860.75

CH	Video	Audio
0*	46.25	51.75
1	57.25	62.75
2	64.25	69.75
3	86.25	91.75
4	95.25	100.75
5	102.25	107.75
5A*	138.25	143.75
6	175.25	180.75
7	182.25	187.75
8	189.25	194.75
9	196.25	201.75
10	209.25	214.75
11	216.25	221.75
28	527.25	532.75
29	534.25	539.75
30	541.25	546.75
31	548.25	553.75
32	555.25	560.75
33	562.25	567.75
34	569.25	574.75
35	576.25	581.75
36	583.25	588.75
37	590.25	595.75
38	597.25	602.75

CH	Video	Audio
39	604.25	609.75
40	611.25	616.75
41	618.25	623.75
42	625.25	630.75
43	632.25	637.75
44	639.25	644.75
45	646.25	651.75
46	653.25	658.75
47	660.25	665.75
48	667.25	672.75
49	674.25	679.75
50	681.25	686.75
51	688.25	693.75
52	695.25	700.75
53	702.25	707.75
54	709.25	714.75
55	716.25	721.75
56	723.25	728.75
57	730.25	735.75
58	737.25	742.75
59	744.25	749.75
60	751.25	756.75
61	758.25	763.75
62	765.25	770.75

CH	Video	Audio
63	772.25	777.75
64	779.25	784.75
65	786.25	791.75
66	793.25	798.75
67	800.25	805.75
68	807.25	812.75

■ Taiwan channels

CH	Video	Audio
7	175.25	179.75
8	181.25	185.75
9	187.25	191.75
10	193.25	197.75
11	199.25	203.75
12	205.25	209.75

■ New Zealand channels

CH	Video	Audio
1	45.25	50.75
2	55.25	60.75
3	62.25	67.75
4	175.25	180.75
5	182.25	187.75
6	189.25	194.75
7	196.25	201.75
8	203.25	208.75
9	210.25	215.75
10	217.25	222.75
11	224.25	229.75

NOTE:

*In the case of the IC-R3, '0' and '5A' channels are displayed as '12' and '13,' respectively.

16 TV FREQUENCY TABLE

■ China channels

CH	Video	Audio	CH	Video	Audio
1	49.75	56.25	28	631.25	637.75
2	57.75	64.25	29	639.25	645.75
3	65.75	72.25	30	647.25	653.75
4	77.25	83.75	31	655.25	661.75
5	85.25	91.75	32	663.25	669.75
6	168.25	174.75	33	671.25	677.75
7	176.25	182.75	34	679.25	685.75
8	184.25	190.75	35	687.25	693.75
9	192.25	198.75	36	695.25	701.75
10	200.25	206.75	37	703.25	709.75
11	208.25	214.75	38	711.25	717.75
12	216.25	222.75	39	719.25	725.75
13	471.25	477.75	40	727.25	733.75
14	479.25	485.75	41	735.25	741.75
15	487.25	493.75	42	743.25	749.75
16	495.25	501.75	43	751.25	757.75
17	503.25	509.75	44	759.25	765.75
18	511.25	517.75	45	767.25	773.75
19	519.25	525.75	46	775.25	781.75
20	527.25	533.75	47	783.25	789.75
21	535.25	541.75	48	791.25	797.75
22	543.25	549.75	49	799.25	805.75
23	551.25	557.75	50	807.25	813.75
24	559.25	565.75	51	815.25	821.75
25	607.25	613.75	52	823.25	829.75
26	615.25	621.75	53	831.25	837.75
27	623.25	629.75	54	839.25	845.75

■ Indonesian channels

CH	Video	Audio	CH	Video	Audio
2	48.25	53.75	37	599.25	604.75
3	55.25	60.75	38	607.25	612.75
4	62.25	67.75	39	615.25	620.75
5	175.25	180.75	40	623.25	628.75
6	182.25	187.75	41	631.25	636.75
7	189.25	194.75	42	639.25	644.75
8	196.25	201.75	43	647.25	652.75
9	203.25	208.75	44	655.25	660.75
10	210.25	215.75	45	663.25	668.75
11	217.25	222.75	46	671.25	676.75
12	224.25	229.75	47	679.25	684.75
21	471.25	476.75	48	687.25	692.75
22	479.25	484.75	49	695.25	700.75
23	487.25	492.75	50	703.25	708.75
24	495.25	500.75	51	711.25	716.75
25	503.25	508.75	52	719.25	724.75
26	511.25	516.75	53	727.25	732.75
27	519.25	524.75	54	735.25	740.75
28	527.25	532.75	55	743.25	748.75
29	535.25	540.75	56	751.25	756.75
30	543.25	548.75	57	759.25	764.75
31	551.25	556.75	58	767.25	772.75
32	559.25	564.75	59	775.25	780.75
33	567.25	572.75	60	783.25	788.75
34	575.25	580.75	61	791.25	796.75
35	583.25	588.75	62	799.25	804.75
36	591.25	596.75	63	807.25	812.75

TV FREQUENCY TABLE 16

■ Italian channels

CH	Video	Audio
64	815.25	820.75
65	823.25	828.75
66	831.25	836.75
67	839.25	844.75
68	847.25	852.75
69	855.25	860.75

CH	Video	Audio
A*	53.75	59.25
B*	62.25	67.75
C*	82.25	87.75
D*	175.25	180.75
E*	183.25	188.75
F*	192.25	197.75
G*	201.25	206.75
H*	210.25	215.75
H1*	217.25	222.75
H2*	224.25	229.75
21	471.25	476.75
22	479.25	484.75
23	487.25	492.75
24	495.25	500.75
25	503.25	508.75
26	511.25	516.75
27	519.25	524.75
28	527.25	532.75
29	535.25	540.75
30	543.25	548.75
31	551.25	556.75
32	559.25	564.75
33	567.25	572.75
34	575.25	580.75
35	583.25	588.75
36	591.25	596.75
37	599.25	604.75

CH	Video	Audio
38	607.25	612.75
39	615.25	620.75
40	623.25	628.75
41	631.25	636.75
42	639.25	644.75
43	647.25	652.75
44	655.25	660.75
45	663.25	668.75
46	671.25	676.75
47	679.25	684.75
48	687.25	692.75
49	695.25	700.75
50	703.25	708.75
51	711.25	716.75
52	719.25	724.75
53	727.25	732.75
54	735.25	740.75
55	743.25	748.75
56	751.25	756.75
57	759.25	764.75
58	767.25	772.75
59	775.25	780.75
60	783.25	788.75
61	791.25	796.75
62	799.25	804.75
63	807.25	812.75
64	815.25	820.75

■ FOT channels

CH	Video	Audio
65	823.25	828.75
66	831.25	836.75
67	839.25	844.75
68	847.25	852.75
69	855.25	860.75

CH	Video	Audio
4	175.25	181.75
5	183.25	189.75
6	191.25	197.75
7	199.25	205.75
8	207.25	213.75
9	215.25	221.75

NOTE:

*In the case of the IC-R3, 'A'-'H,' 'H1' and 'H2' channels are displayed as '1'-'8,' '9' and '10,' respectively.

17 SPECIFICATIONS AND OPTIONS

◆ General

- Frequency coverage : (unit: MHz)
 - U.S.A. version 0.495–815.995,
902–2450.095
 - Non-U.S.A. versions 0.495–2450.095
- Mode : FM, AM, WFM, AM-TV,*1
FM-TV,*2
 - *1 One of either NTSC M, PAL B or PAL G systems.
 - *2 For 900–1300 MHz and 2250–2450 MHz ranges only; not available in some versions.
- No. of memory channels : 450 (50 channel × 8 banks plus
50 scan edges)
- Usable temp. range : –10°C to +60°C;
+14°F to +140°F
- Tuning steps : 5, 6.25, 9,*3 10, 12.5, 15, 20,
25, 30, 50 and 100 kHz
 - *3 Fixed tuning step while 0.495–1.620 MHz is selected except for U.S.A. and Canada versions.
- Frequency stability : ±6 ppm max. (–10°C to +50°C)
- Power supply requirement : 3.6–6.3 V DC
(negative ground)
- Current drain (at 4.5 V DC) :
 - At rated output 210 mA typical (backlight OFF)
 - At stand-by 140 mA typical
 - Power save 53 mA typical
 - TV reception 730 mA typical (color LCD ON)
- Antenna connector : BNC (50 Ω)

- Dimensions : 61(W)×120(H)×32.9(D) mm;
(projections not included) 2¹³/₃₂(W)×4²³/₃₂(H)×1⁹/₃₂(D) in
- Weight : 300 g; 10.6 oz
(w/antenna and battery)

◆ Receiver

- Receive system : Triple-conversion*4
superheterodyne
 - *4 below 1150 MHz; Quadruple-conversion for above 1150 MHz
- Intermediate frequencies :

	AM, FM	WFM	TV	
			U.S.A.*5	Europe*6
1st	240.1	240.1	241.85*5	238.35*6
2nd	26.05	13.25	45.75	38.90
3rd	0.450	0.450	–	

- *5 30–799.995, 1321–2099.995 MHz range
- *6 800–1320.995, 2100–2450.095 MHz range

- Sensitivity (except spurious points; typical):

FM	1.625–4.995 MHz	0.32 μV
(at 12 dB SINAD)	5.0–469.995 MHz	0.25 μV
	470–799.995 MHz	0.45 μV
	800–1999.995 MHz	0.56 μV
	2000–2299.995 MHz	1.0 μV
	2300–2450.095 MHz	1.8 μV
WFM	76–107.995 MHz	1.0 μV
(at 12 dB SINAD)	175–221.995 MHz	1.0 μV
	470–769.995 MHz	1.8 μV

- AM (at 10 dB S/N)
 - 0.495–4.995 MHz 1.4 μ V
 - 5.0–29.995 MHz 1.0 μ V
 - 118–136.000 MHz 0.79 μ V
 - 222–329.995 MHz 1.0 μ V
- Selectivity :
 - FM, AM More than 12 kHz/–6 dB
 - Less than 30 kHz/–50 dB
 - WFM More than 150 kHz/–6 dB
- Audio output power : 100 mW typical at 10% distortion with an 8 Ω load (at 4.5 V DC)
- SP connector : 3-conductor 3.5 (d) mm (1/8")/8 Ω
- Audio/Video connector : 3-conductor 3.5 (d) mm (1/8")

◆ Operating periods (Approx.)

	TV reception color LCD ON	Rated output backlight OFF	Power save
BP-206	1 hr. 45 min.	2 hrs. 10 min.	25 hrs. 30 min.
Alkaline batteries*	45 min.	57 min.	27 hrs. 30 min.
Ni-Cd batteries*	50 min.	60 min.	12 hrs. 50 min.

* Operating periods depend on batteries used.

All stated specifications are subject to change without notice or obligation.

Microsoft® and Windows® are registered trademarks of Microsoft Corporation in the U.S.A and other countries.

◆ Options

BC-135 DESKTOP CHARGER

Used for rapid charging of Li-Ion battery pack. Charging time: 2.5 hours. An AC adapter is supplied with the charger.

BC-153A/D BATTERY CHARGER

Allows you to operate the receiver, and also charges a Li-Ion battery pack regularly.

BP-206 Li-Ion BATTERY PACK

3.7 V/1650 mAh Lithium Ion battery pack. Same as supplied one.

CP-18A/E CIGARETTE LIGHTER CABLE

Allows you to operate the receiver through a 12 V cigarette lighter socket, and also charges a Li-Ion battery pack regularly. A DC-DC converter is built-in.

LC-151 CARRYING CASE

Helps protect the receiver from scratches, etc.

SP-13 EARPHONE

Provides clear receive audio in noisy environments.

CS-R3 CLONING SOFTWARE + **OPC-478** CLONING CABLE

Allows you to transfer data from memories, etc. and quickly and easily edit and store data via a PC (for Microsoft® Windows® 95 and 98).

OPC-474 CLONING CABLE

Used for receiver-to-receiver cloning.

18 TROUBLESHOOTING

If your receiver seems to be malfunctioning, please check the following points before sending it to a service center.

PROBLEM	POSSIBLE CAUSE	SOLUTION	REF.
No power comes ON.	<ul style="list-style-type: none">•The batteries are exhausted.•The battery polarity is reversed.	<ul style="list-style-type: none">•Replace the batteries or charge the battery pack.•Check the battery polarity.	pgs. 1, 46 p. 1
No sound comes from the speaker.	<ul style="list-style-type: none">•Volume level is too low.•The squelch level is set too tight.•Different tone is selected with tone squelch.	<ul style="list-style-type: none">•Push [UP] to obtain a suitable level.•Open the squelch.•Check the tone using tone scan.	p. 11 p. 11 p. 30
Frequency cannot be set.	<ul style="list-style-type: none">•The lock function is activated.	<ul style="list-style-type: none">•Push [FUNC] + [MODE (SET)] for 2 sec. to cancel the function.	p. 9
No beeps sound.	<ul style="list-style-type: none">•Beep tones are turned OFF or the beep tone level is low.	<ul style="list-style-type: none">•Turn beep tones ON or set the beep tone level to appropriate level in set mode.	p. 40
Receive audio is distorted.	<ul style="list-style-type: none">•The operating mode is not selected correctly.	<ul style="list-style-type: none">•Push [MODE] to select a suitable operating mode.	p. 12
Desired set mode item cannot be selected.	<ul style="list-style-type: none">•Some set mode items can be selected only when the color LCD is ON.•Some set mode items cannot be selected in the broadcast band.	<ul style="list-style-type: none">•Turn the color LCD ON.•Choose a band other than the broadcast band.	pgs. 6, 38 p. 38

QUICK REFERENCE 19

Important operating instructions are summed up in this and the following page for your simple reference.

By cutting along the line and folding on the dotted line, it will become a card sized operating guide which can easily be carried in a card case or wallet, etc.

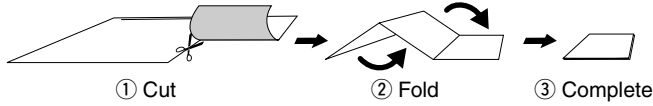

ICOM OPERATING GUIDE IC-R3

■ BASIC OPERATION

- 1 Push [POWER] for 2 sec.
 - 2 Push [] to set the desired audio level.
 - 3 Select VFO mode with [V/M].
 - 4 Select the desired band with [].
 - 5 Rotate [DIAL] to change the frequency.
- The frequency changes according to the preset tuning steps.
- 6 Set the squelch level.
- While pushing [SQL], rotate [DIAL].
 - The first click of [DIAL] indicates the current squelch level.
 - “LEVEL1” is loose squelch and “LEVEL9” is tight squelch.

•“AUTO” indicates automatic level adjustment.

- 5 When a signal is received:

- Squelch opens and audio is emitted from the speaker.
- The S/RF indicator shows the relative signal strength.

Using the dial select step (p. 39)

Rotate [DIAL] while pushing [FUNC] to change the frequency in 100 kHz, 1 MHz or 10 MHz steps.

■ DUPLEX OPERATION

- 1 Set the receive station frequency (e.g. repeater output frequency).
- 2 Set the shift direction of the transmit station frequency in set mode. (–DUP or DUP)
- 3 Push and hold [SQL] to monitor the transmit station’s frequency.

Tone scan (p. 30)

Push [FUNC] + [] for 2 sec. to start the tone scan.

■ MEMORY CHANNEL SELECTION

- 1 Push [V/M] to select memory mode.
- 2 “M” or “MEM” appears. Select a memory channel with [DIAL].
- 3 Rotate [DIAL] while pushing [FUNC] to select the memory bank.

■ MEMORY CLEAR

- 1 Select the desired memory channel.
- 2 Select VFO mode with [V/M] and push [V/M] for 1 sec. to indicate the channel.
- 3 Push [FUNC] + [V/M] for 2 sec.

—CUT HERE—

■ SCAN

Full/band/programmed scan

- ① Select VFO mode with [V/M].
- ② Make sure the squelch is set to the threshold point.
- ③ Push [] for 2 sec. to start the scan.
- Rotate [DIAL] while pushing [] to select scan edge, if desired.
- To change the scanning direction, rotate [DIAL].
- ④ Push [] again to stop the scan.

Memory (bank) scan

- ① Select memory mode with [V/M].
- ② Make sure the squelch is set to the threshold point.
- ③ Push [] for 2 sec. to start the scan.
- Rotate [DIAL] while pushing [] to turn memory bank scan ON or OFF, if desired.

- ④ Push [] again to stop the scan.

■ SET MODE

- ① Push [F/UNC] + [(MODE)SET] momentarily to enter set mode.
- Select non-band scope screen in advance for color LCD.
- ② Rotate [DIAL] to select a display.
- ③ Push [] or rotate [DIAL] while pushing [F/UNC] to set the condition.
- ④ Push [(MODE)SET] to exit set mode.

■ LOCK FUNCTION

- Push [F/UNC] + [(MODE)SET] for 2 sec. to toggle the lock function ON or OFF. (p. 9)

■ CPU RESETTING

Partial resetting (p. 45)

- While pushing [F/UNC] and [V/M], turn power on to partially reset the receiver.
- Partial resetting does not clear the memory channel contents.

Total resetting (p. 45)

- While pushing [F/UNC], [V/M] and [(MODE)], turn power on to reset the receiver.

Caution: Resetting the receiver initializes all memory contents.



DECLARATION OF CONFORMITY

We Icom Inc. Japan
6-9-16, Kamihigashi, Hirano-ku
Osaka 547-0002, Japan

Declare on our sole responsibility that this equipment complies the essential requirements of the Radio and Telecommunications Terminal Equipment Directive, 1999/5/CE.



Düsseldorf 11. July. 2000

Place and date of issue

Kind of equipment: COMMUNICATIONS RECEIVER

Type-designation: IC-R3

Version (where applicable): _____

This compliances is based on conformity with the following harmonised standards, specifications or documents:

- i) EN 60950
- ii) prEN 301 489-1
- iii) prEN 301 489-15
- iv) prEN 301 783-2
- v) _____

Icom (Europe) GmbH
Himmelgeister straÙe 100
D-40225 Düsseldorf

Authorized representative name

Icom (Europe) GmbH

T. Aoki
General Manager

Signature

Icom Inc.

Count on us!

#02 EUR
#12 EUR-1
#22 EUR-2

< Intended Country of Use >

GER FRA ESP SWE
 AUT NED POR DEN
 GBR BEL ITA FIN
 IRL LUX GRE SUI
 NOR

#03 UK
#13 UK-1
#23 UK-2

< Intended Country of Use >

GER FRA ESP SWE
 AUT NED POR DEN
 GBR BEL ITA FIN
 IRL LUX GRE SUI
 NOR